



Metasol

Meta Solution

Contactors and Overload relays



Metasol Contactors and Overload Relays

New generation of Contactors from LSIS



Metasol Contactors

- **Designed to show superior technology:
The Metasol series**

Sealed structure has improved its safety features so that no arc flash is exposed. In order to emphasize its durability as an industrial device, Metasol series adopt simple design form and sophisticated shape applying diamond cut concepts on product surface.



LSIS META SOLUTION CONTACTORS

Contents :

Table of specifications	10
Type numbering system	18
Environment	20
Connections	21
Control coil characteristics	22
Marking	24
Internal structure	25
3-pole Contactors	26
Motor starters	48
Reversing contactors	52
LED voltage monitoring contactor	54
Contactors relays	55
Latching contactors	56
4-pole Contactors	60
Enclosed motor starters, Mold enclosure	72
Enclosed motor starters, Steel enclosure	73
Capacitor contactors	74
2-pole AC Contactors, Definite purpose	75
3-pole AC Contactors, Definite purpose	76
Single-pole AC Contactors, Definite purpose	77
2-pole DC Contactors	78
Accessory	79
Overload relays	92
Overload relay specifications	94
Overload relay operation	96
Accessories for overload relay	97
Overload relay ordering types	102
Overload relay trip curves	108
Type 2 Coordination (380/415V)	116
Type 2 Coordination (440V)	119
Rated UL 508 combination motor controller Type-C	125
Rated UL 508 combination motor controller Type-F	128
Dimension	131
Comparison table	172
Certifications	178



Metasol Series completion

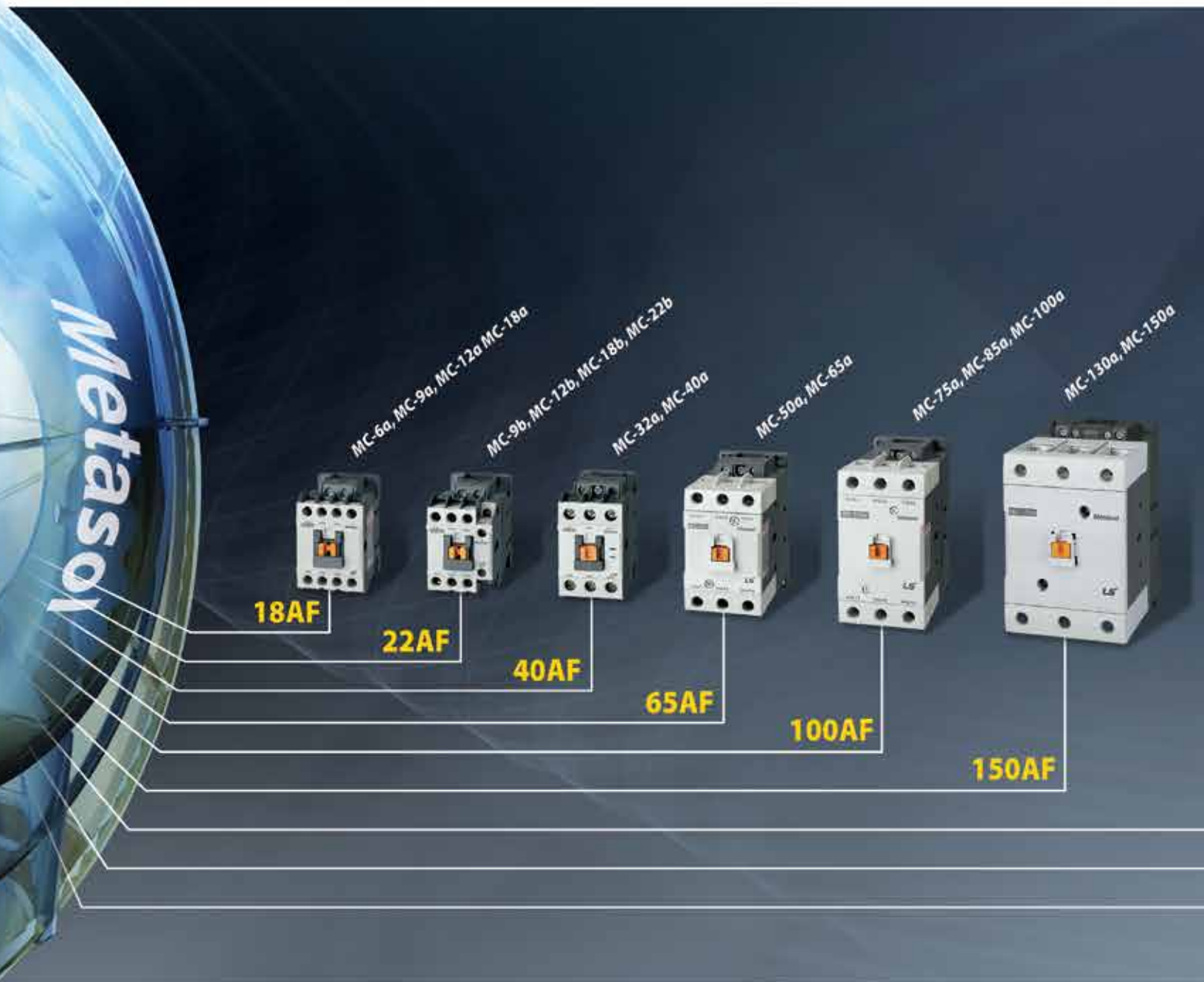

More Safe,
More Valuable



Contactors & Overload Relays



- *Advanced technology & Expert solution*
- *Offering economical solution with compact size & easy connection*
- *Ensure reliability in the system: Type II Coordination*
- *Perfect system with peripheral devices.*
- *Environment friendly product: complies with International environment standard RoHS.*
- *25 Models in 9 Frames*

Motor Starters

- Compact design for space saving
- DIN rail and screw mountable (upto 150AF)
- Overload relays directly mountable to contactors separately
- Finger-proof design
- Easy to combine with manual motor starters
- Broad range of accessories
- World class products conforming to IEC and UL standards



18AF

Contactor
MC-6a, 9a, 12a, 18a

Rated current:
6, 9, 12, 18A
Rated insulation voltage:
690V

Overload relay MT-12

Current range: 0.1~18A
Trip class: Class10A, 20

22AF

Contactor
MC-9b, 12b, 18b, 22b

Rated current:
9, 12, 18, 22A
Rated insulation voltage:
690V

Overload relay MT-32

Current range: 0.1~40A
Trip class: Class10A, 20

40AF

Contactor
MC-32a, 40a

Rated current:
32, 40A
Rated insulation voltage:
1000V

Overload relay MT-32

Current range: 0.1~40A
Trip class: Class10A, 20

65AF

Contactor
MC-50a, 65a

Rated current:
50, 65A
Rated insulation voltage:
1000V

Overload relay MT-63

Current range: 4~65A
Trip class: Class10A, 20

100AF

Contactor
MC-75a, 85a, 100a

Rated current:
75, 85, 100A
Rated insulation voltage:
1000V

Overload relay MT-95

Current range: 7~100A
Trip class: Class10A, 20

150AF

Contactor
MC-130a, 150a

Rated current:
130, 150A
Rated insulation voltage:
1000V

Overload relay MT-150

Current range: 34~150A
Trip class: Class10A, 20

MS-500a, MS-630a, MS-800a

MS-185a, MS-225a

MS-265a, MS-330a, MS-400a



225AF

400AF

800AF

225AF

Contactor
MC-185a, 225a

Rated current:
185, 225A
Rated insulation voltage:
1000V

Overload relay MT-225

Current range: 65~240A
Trip class: Class10A, 20

400AF

Contactor
MC-265a, 330a, 400a

Rated current:
265, 330, 400A
Rated insulation voltage:
1000V

Overload relay MT-400

Current range: 85~400A
Trip class: Class10A, 20

800AF

Contactor
MC-500a, 630a, 800a

Rated current:
500, 630, 800A
Rated insulation voltage:
1000V

Overload relay MT-800

Current range: 200~800A
Trip class: Class10A, 20

1260AF

Contactor
MC-1260a

Rated current:
1260A
Rated insulation voltage:
1000V

2100AF

Contactor
MC-1400a, 1700a, 2100a

Rated current:
1400, 1700, 2100A
Rated insulation voltage:
1000V

MC/TOR Accessories

Perfect combination of peripheral devices and various accessories



Offering economical solution with compact size & easy connection



Perfect system with other devices and accessories

■ One-touch connection

- Din Rail connection without any special tools
- Direct combine a surge unit

■ Simple wiring

- Mounting unit, Adapter
- Reversing wire set

■ Easy Maintenance

- 4-terminal type: Easy wiring of operation coil
- Module type of Screw terminal
- Interlock unit with built-in auxiliary contacts(2NO built-in)

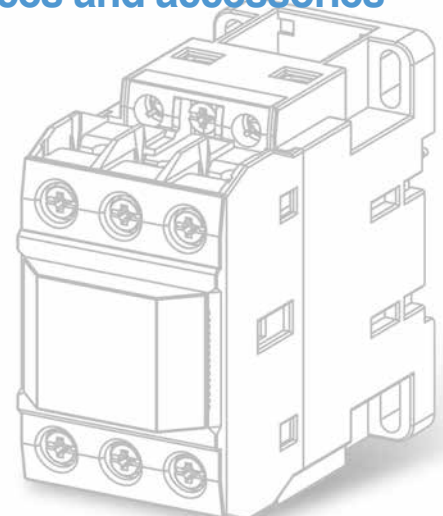

Advanced accessories for Metasol contactors

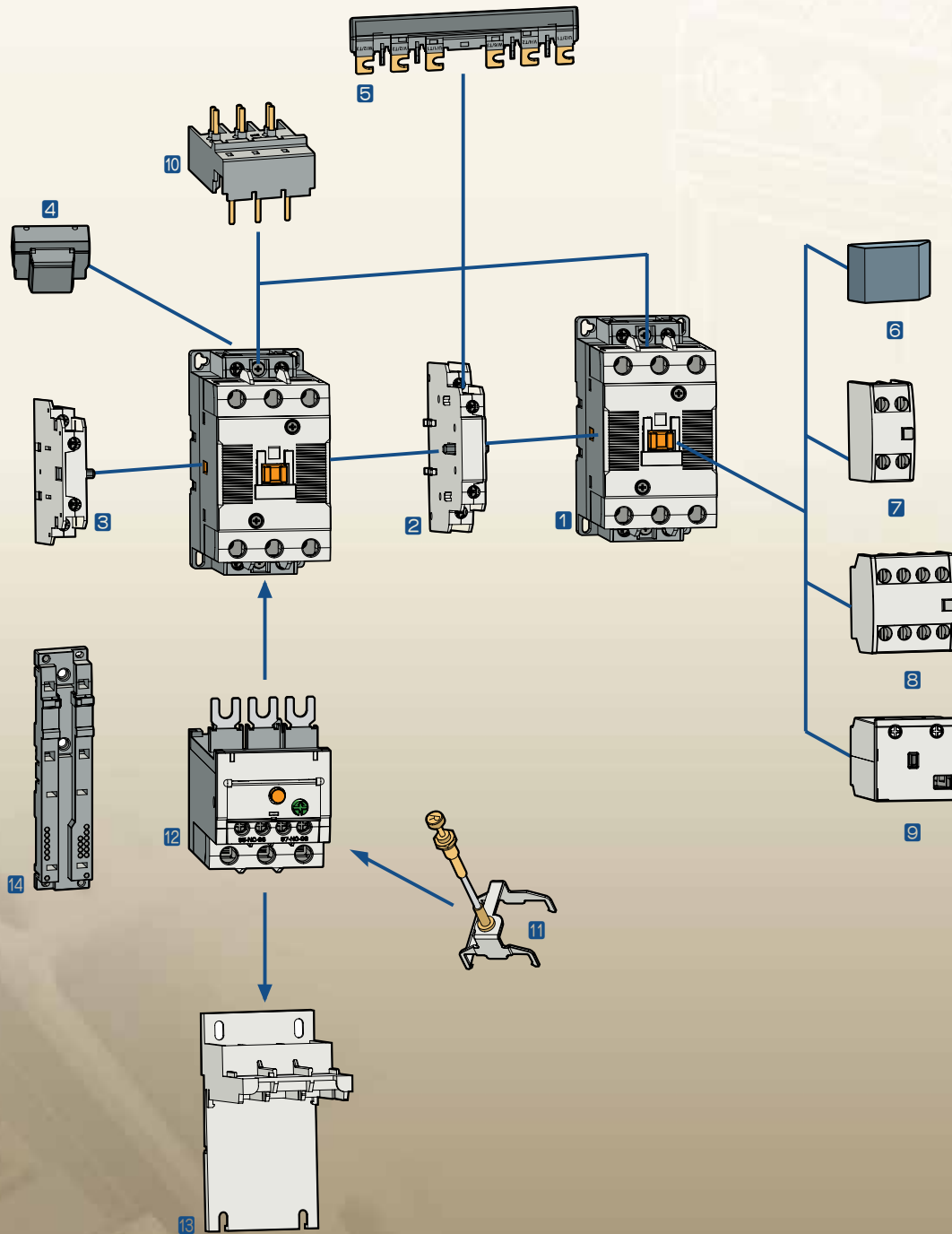

- | | | |
|--|---|-----------------------------------|
| 1 Contactor | 6 Safety cover (Option) | 10 Direct adaptor to MMS |
| 2 Interlock unit | 7 Auxiliary contact unit
- front mount(2p) | 11 Remote reset unit |
| 3 Auxiliary contact unit
- side mount | 8 Auxiliary contact unit
- front mount(4p) | 12 Overload relay |
| 4 Surge unit | 9 Mechanical latch unit | 13 Separate mounting unit |
| 5 Wire kit | | 14 Mounting unit for use with MMS |

Table of specifications

MC type Magnetic Contactors



Frame size			
Type	screws clamp terminals		
Number of poles	3pole		
Rated operational voltage, Ue	690V		
Rated insulation voltage, Ui	690V		
Rated frequency	50/60Hz		
Rated impulse withstand voltage, Uimp	6kV		
Maximum operating rate in operating cycles per hour(AC3)	1800 operations per hour		
Durability	Mechanical	15 mil. operations	
	Electrical	2.5 mil. operations	
Current and power	AC-1, Thermal current	A	
	AC-3 200/240V	kW	
	380/440V	kW	
	500/550V	kW	
	690V	kW	
	1000V	kW	
	Rated Short-time withstand current (IEC 60947)	1s	A
		10s	A
		30s	A
		1min	A
	3min	A	
	10min	A	
	≥15min	A	
UL rating (50/60Hz)	Continuous current	A	
	Single phase	110~120V HP	
		220~240V HP	
		200~208V HP	
	Three phase	220~240V HP	
		440~480V HP	
		550~600V HP	
Size and weight	NEMA size		
	AC control	Weight kg Size(W×H×D) mm	
Auxiliary (standard)	DC control	Weight kg Size(W×H×D) mm	
	Auxiliary	Side mount Front mount	

18AF			
MC-6a	MC-9a	MC-12a	MC-18a
●	●	●	●
3pole			
690V			
690V			
50/60Hz			
6kV			
1800 operations per hour			
15 mil. operations			
2.5 mil. operations			
25	25	25	32
2.2	2.5	3.5	4.5
9	11	13	18
3	4	5.5	7.5
7	9	12	18
3	4	7.5	7.5
6	7	12	13
3	4	7.5	7.5
4	5	9	9
-	-	-	-
-	-	-	-
210	250	280	300
105	110	120	130
70	70	80	85
61	61	61	70
40	45	47	50
30	30	30	40
25	26	28	40
25	25	25	32
0.5	0.5	0.75	1
1.5	1.5	2	3
2	2	3	7.5
3	3	5	7.5
5	5	7.5	10
7.5	7.5	10	15
00	00	0	1
0.33			
45×73.5×80.4			
0.4			
45×73.5×96.6			
1NO or 1NC			
UA-1			
UA-2, UA-4			

22AF			
MC-9b	MC-12b	MC-18b	MC-22b
●	●	●	●
3pole			
690V			
690V			
50/60Hz			
6kV			
1800 operations per hour			
15 mil. operations			
2.5 mil. operations			
25	25	40	40
2.5	3.5	4.5	5.5
11	13	18	22
4	5.5	7.5	11
9	12	18	22
4	7.5	7.5	15
7	12	13	20
4	7.5	7.5	15
6	9	9	18
-	-	-	-
-	-	-	-
250	280	300	400
110	120	154	186
70	80	100	130
61	61	84	90
45	50	60	60
30	30	40	50
26	28	40	45
25	25	40	40
0.5	0.75	1	2
1.5	2	3	3
2	3	7.5	7.5
3	5	7.5	10
5	7.5	10	15
7.5	10	15	20
00	0	1	
0.34			
45×73.5×87.4			
0.41			
45×73.5×103.6			
1NO1NC			
UA-1			
UA-2, UA-4			

Note) Minimum conduct current of Auxiliary contactor is DC 17V 5mA.

MT type Thermal Overload Relays



Type		
Screws c terminals		
Rated operational voltage, Ue	690V	
Rated insulation voltage, Ui	690V	
Rated impulse withstand voltage, Uimp	6kV	
Trip class	10A, 20	
Setting range	0.1~18A	
Size and weight	Weight	kg
	Size(W×H×D)	mm

MT-12/□	
●	
690V	
690V	
6kV	
10A, 20	
0.1~18A	
0.1	
45×73.2×63.7	

MT-32/□	
●	
690V	
690V	
6kV	
10A, 20	
0.1~40A	
0.17	
45×75×90	

* The safety cover of magnetic contactor and thermal overload relay is optional.



40AF	
MC-32a	MC-40a
●	●
3pole	
1000V	
1000V	
50/60Hz	
8kV	
1800 operations per hour	
12 mil. operations	
2 mil. operations	
50	50
7.5	11
32	40
15	18.5
32	40
18.5	22
28	32
18.5	22
20	23
22	22
17	17
600	700
260	300
160	160
100	100
70	70
55	55
50	50
50	50
2	2
5	5
7.5	7.5
10	10
20	20
25	25
1P	2
0.55	
69×83×90	
0.77	
69×83×117.1	
2a2b	
UA-1	
UA-2, UA-4	



MT-32/□
●
690V
690V
6kV
10A, 20
0.1~40A
0.17
45×75×90



65AF	
MC-50a	MC-65a
●	●
3pole	
1000V	
1000V	
50/60Hz	
8kV	
1200 operations per hour	
12 mil. operations	
2 mil. operations	
70	100
15	18.5
55	65
22	30
50	65
30	33
43	60
30	33
28	35
30	30
23	23
1000	1050
550	700
330	380
250	270
150	200
90	120
87	100
70	100
3	5
10	15
20	25
25	30
40	50
50	60
1.05	
79×106×119	
1.3	
79×106×146.4	
2a2b	
UA-1	
UA-2, UA-4	



MT-63/□
●
690V
690V
6kV
10A, 20
4~65A
0.31/0.33
55×81×100



100AF		
MC-75a	MC-85a	MC-100a
●	●	●
3pole		
1000V		
1000V		
50/60Hz		
8kV		
1200 operations per hour		
12 mil. operations		
2 mil. operations		
110	135	160
22	25	30
75	85	105
37	45	55
75	85	105
37	45	55
64	75	85
37	45	55
42	45	65
37	37	37
28	28	28
1100	1200	1320
750	800	900
400	450	500
300	350	400
220	270	270
140	170	180
114	150	160
110	135	160
5	7.5	10
15	15	20
25	30	30
30	40	40
50	60	75
60	75	75
1.93		
94×140×135.8		
2.8		
94×140×172.3		
2a2b		
UA-1		
UA-2, UA-4		



MT-95/□
●
690V
690V
6kV
10A, 20
7~100A
0.48/0.5
70×97×110

Table of specifications

MC type Magnetic Contactors



Frame size			
Type	screws clamp terminals		
Number of poles	3pole		
Rated operational voltage, Ue	1000V		
Rated insulation voltage, Ui	1000V		
Rated frequency	50/60Hz		
Rated impulse withstand voltage, Uimp	8kV		
Maximum operating rate in operating cycles per hour(AC3)	1200 operations per hour		
Durability	Mechanical	5 mil. operations	
	Electrical	1 mil. operations	
Current and power	AC-1, Thermal current	A	
	AC-3 200/240V	kW	
	380/440V	kW	
	500/550V	kW	
	690V	kW	
	1000V	kW	
	Rated Short-time withstand current (IEC 60947)	1s	A
	10s	A	
	30s	A	
	1min	A	
3min	A		
10min	A		
≥15min	A		
UL rating (50/60Hz)	Continuous current	A	
	Single phase	110~120V	HP
		220~240V	HP
		200~208V	HP
	Three phase	220~240V	HP
		440~480V	HP
	550~600V	HP	
Size and weight	NEMA size		
	AC control	Weight kg Size(W×H×D) mm	
Auxiliary(standard)	DC control	Weight kg Size(W×H×D) mm	
	Side mount		
Auxiliary	Front mount		



150AF	
MC-130a	MC-150a
●	●
3pole	
1000V	
1000V	
50/60Hz	
8kV	
1200 operations per hour	
5 mil. operations	
1 mil. operations	
160	210
37	45
130	150
60	75
130	150
60	70
90	100
55	55
60	60
75	75
53	53
1350	1800
950	1200
700	800
550	600
350	450
200	300
175	280
160	210
10	15
20	25
40	40
40	50
75	100
75	75
	4
2.4	
119×158×130.3	
2a2b	
UA-1	
UA-2, UA-4	

225AF	
MC-185a	MC-225a
●	●
3pole	
1000V	
1000V	
50/60Hz	
8kV	
1200 operations per hour	
5 mil. operations	
1 mil. operations	
230	275
55	75
185	225
90	132
185	225
110	132
180	200
110	140
120	150
132	132
90	90
2000	2500
1500	1700
1000	1200
800	1000
350	500
320	400
230	275
15	15
30	40
60	60
60	75
125	150
125	150
5.4	
138×203×185.1	
2a2b	
AU-100, AU-100E (Max.4a4b)	
-	

400AF		
MC-265a	MC-330a	MC-400a
●	●	●
3pole		
1000V		
1000V		
50/60Hz		
8kV		
1200 operations per hour		
5 mil. operations		
2.5 mil. operations		
1 mil. operations		
300	350	450
80	90	125
265	330	400
147	160	200
265	330	400
147	160	225
225	250	350
160	200	250
185	220	300
147	147	147
105	105	105
3500	4000	4600
2400	3000	4400
1500	2500	2974
1100	1700	1846
800	1000	1313
600	620	760
500	553	699
300	350	450
-	-	-
-	-	-
75	100	125
100	100	150
200	200	300
200	200	300
9.2		
163×243×204.4		
2a2b		
AU-100, AU-100E (Max.4a4b)		
-		

MT type Thermal Overload Relays



Type	
Screws clamp terminals	
Rated operational voltage, Ue	690V
Rated insulation voltage, Ui	690V
Rated impulse withstand voltage, Uimp	6kV
Trip class	10A, 20
Setting range	34~150A
Size and weight	Weight kg
	Size(W×H×D) mm



MT150/□
●
690V
690V
6kV
10A, 20
34~150A
0.67
95×109×113

MT225/□
●
690V
690V
6kV
10A, 20
65~240A
2.5
147×141×184

MT400/□
●
690V
690V
6kV
10A, 20
85~400A
2.6
151×171×198

* The safety cover of magnetic contactor and thermal overload relay is optional.



800AF

MC-500a	MC-630a	MC-800a
●	●	●
	3pole	
	1000V	
	1000V	
	50/60Hz	
	8kV	
	1200 operations per hour	
	2.5 mil. operations	
	0.5 mil. operations	
580	660	900
147	190	220
500	630	800
265	330	440
500	630	800
265	330	500
400	500	720
300	400	500
380	420	630
280	280	280
220	220	220
6000	7000	7500
5050	6400	7000
4400	4500	4900
3400	3500	3800
2000	2200	2500
1400	1550	1550
1100	1300	1300
580	660	900
-	-	-
-	-	-
150	200	200
200	250	300
400	500	600
400	500	600
6		7

22.4
285 × 312 × 245.3

2a2b
AU-100, AU-100E (Max.4a4b)



MT-800/ □
●
690V
690V
6kV
10A, 20
200~800A
11.5
360 × 530 × 212

1260AF

MC-1260a
●
3pole
1000V
1000V
50/60Hz
8kV
300 operations per hour
0.5 mil. operations
0.5 mil. operations
1260
-
-
900
1450
-
-
-
-
-
8000
7200
5200
4000
2300
3000
1500
-
-
-

23.5
285 × 352 × 246

2a2b
AU-100, AU-100E (Max.4a4b)

2100AF

MC-1400a	MC-1700a	MC-2100a
●	●	●
	3pole	
	1000V	
	1040V	
	50/60Hz	
	8kV	
	300 operations per hour	
	0.5 mil. operations	
	0.05 mil. operations	
1400	1700	2100
275	320	-
860	1050	-
550	700	900
860	1050	1450
-	-	-
-	-	-
860	950	-
860	950	-
-	-	-
-	-	-
8000	10000	10000
-	-	-
4500	5500	5500
-	-	-
2600	3000	3000
-	-	-
1400	1700	2100
-	-	-
-	-	-

33.8
431 × 380 × 246

2a2b
AU-100, AU-100E (Max.4a4b)

Table of specifications

MC type Magnetic Contactors (4pole)



Frame size			
Type	Screw clamp terminal		
Number of poles	4		
Rated operational voltage (Ue)	690V		
Rated insulation voltage (Ui)	690V		
Rated frequency	50/60Hz		
Rated impulse withstand voltage, Uimp	6kV		
Maximum operating rate in operating cycles per hour(AC1)	1800 operations per hour		
Durability	Mechanical		
	Electrical		
Current and Power	AC-1	Thermal current	A
		200/240V	kW
		380/400V	kW
			A
		500/550V	kW
		690V	kW
UL rating (50/60Hz)	Continuous current	A	
		Single	110~120V HP
	Phase	220~240V	HP
		200~208V	HP
		220~240V	HP
	Phase	440~480V	HP
		550~600V	HP
Size and weight	AC Control	Weight	kg
		Size(W×H×D)	mm
	DC Control	Weight	kg
		Size(W×H×D)	mm
Auxiliary(standard)			
Auxiliary	Side Mount		
	Front Mount		



18AF			
MC-6a/4	MC-9a/4	MC-12a/4	MC-18a/4
•			
4pole			
690V			
690V			
50/60Hz			
6kV			
1800 operations per hour			
15 mil. Operations			
0.5 mil. Operations		0.8 mil. Operations	
25	25	25	40
9	9	9	15
25	25	25	40
17	17	17	27
25	25	25	40
21	21	21	35
25	25	25	40
27	27	27	44
25	25	25	40
25	25	25	32
0.5	0.5	0.75	1
1.5	1.5	2	3
2	2	3	5
3	3	5	7.5
5	5	7.5	10
7.5	7.5	10	15
0.33			
45×73.5× 79			
0.4			
45×73.5×96.6			
-			
UA-1			
UA-2, UA-4			



22AF	
MC-22a/4	
●	
4pole	
690V	
690V	
50/60Hz	
6kV	
1800 operations	
15 mil. Operations	
1 mil. Operations	
40	
15	
40	
27	
40	
35	
40	
44	
40	
32	
2	
3	
7.5	
7.5	
10	
15	
0.4	
47.2×80×86.8	
0.5	
47.2×80×113.2	
-	
AU-1	
UA-2, UA-4	

40AF	
MC-32a/4	MC-40a/4
●	
4pole	
690V	
690V	
50/60Hz	
6kV	
1800 operations per hour	
15 mil. Operations	
1 mil. Operations	
50	60
18	22
50	60
35	42
50	60
43	52
50	60
55	66
50	60
45	50
2	3
5	5
7.5	10
10	10
20	25
20	25
0.59	
59×83.5×94.5	
0.7	
59×83.5×121	
-	
AU-1	
UA-2, UA-4	

85AF			
MC-50a/4	MC-65a/4	MC-75a/4	MC-85a/4
●			
4pole			
690V			
1000V			
50/60Hz			
8kV			
1800 operations per hour			
12 mil. Operations			
1 mil. Operations			
80	100	110	135
30	37	41	51
80	100	110	135
56	70	76	95
80	100	110	135
70	88	97	120
80	100	110	135
88	110	120	150
80	100	110	135
70	80	90	100
3	5	5	7.5
7.5	10	15	15
10	15	20	25
15	20	25	30
30	40	50	50
30	40	50	50
1.2			
91×123.5×117.8			
1.29			
91×123.5×117.8			
-			
AU-1			
UA-2, UA-4			

Table of specifications

MC type Magnetic Contactors (4pole)



Frame size			
Type	Screw clamp terminal		
Number of poles	4		
Rated operational voltage (Ue)	690V		
Rated insulation voltage (Ui)	1000V		
Rated frequency	50/60Hz		
Rated impulse withstand voltage, Uimp	8kV		
Maximum operating rate in operating cycles per hour(AC1)	1200 operations per hour		
Durability	Mechanical		
	Electrical		
Current and Power	AC-1	Thermal current	A
		200/240V	kW
		380/400V	kW
			A
		500/550V	kW
		690V	kW
UL rating (50/60Hz)	Continuous current	A	
		Single	110~120V HP
	Phase	220~240V	HP
		200~208V	HP
	Three	220~240V	HP
		Phase	440~480V HP
		550~600V	HP
	Size and weight	AC Control	Weight
Size(W×H×D)			mm
DC Control		Weight	kg
		Size(W×H×D)	mm
Auxiliary(standard)			
Auxiliary	Side Mount		
	Front Mount		



* - FLA = 722 A, LRA = 5618 A
 ** - FLA = 566 A, LRA = 4495 A

225AF					
MC-100a/4	MC-130a/4	MC-150a/4	MC-185a/4	MC-225a/4	
●					
4pole					
690V					
1000V					
50/60Hz					
8kV					
1200 operations per hour					
5 mil. Operations					
0.8 mil. Operations					
160	165	250	300	330	
57	60	76	87	100	
150	155	200	230	260	
106	110	142	165	185	
150	155	200	230	260	
132	137	180	205	230	
150	155	200	230	260	
165	170	225	255	290	
150	155	200	230	260	
160	160	210	230	275	
7.5	10	15	15	15	
15	20	25	30	40	
30	40	40	60	60	
30	40	50	60	75	
60	75	100	125	150	
60	75	100	125	150	
5.6					
175×203×185					
2NO2NC					
AU-100, AU-100E					
-					



400AF

MC-265a/4	MC-330a/4	MC-400a/4
	●	
	4pole	
	690V	
	1000V	
	50/60Hz	
	8kV	
	1200 operations per hour	
	2.5 mil. Operations	
	0.5 mil. Operations	
360	420	500
115	135	160
300	350	420
215	250	300
300	350	420
265	315	375
300	350	420
335	390	470
300	350	420
300	350	450
-	-	-
-	-	-
75	100	125
100	125	150
200	250	300
200	250	300

9.9
206×243×205

2NO2NC

AU-100, AU-100E

-

800AF

MC-500a/4	MC-630a/4	MC-800a/4
	●	
	4pole	
	690V	
	1000V	
	50/60Hz	
	8kV	
	1200 operations per hour	
	2.5 mil. Operations	
	0.5 mil. Operations	
630	750	900
245	255	310
630	660	800
450	470	570
630	660	800
560	590	710
630	660	800
710	740	900
630	660	800
580	660	900
-	-	-
-	-	-
150	200	200
200	250	300
400	500	600 *
400	500	600 **

26.3
346×310×244

2NO2NC

AU-100, AU-100E

-

Type numbering system

Contactor

MC65A		40	22	K7	L
Product (6A~2100A)		Main contactor	Auxiliary contact		Coil voltage
MC6A	MC-6a	30	30 None		Coil code Table <i>*note) See page 23 for details</i>
·	·	40	40 Normal 1NO Normal 1NC		
MC2100A	MC-2100a	22	22 Normal 2NO Normal 2NC		S Screw
·	·		11L Low Current 1NO Low current 1NC		
MC9B	MC-9b		22L Low Current 2NO Low current 2NC		L Lug
·	·		11H Hoist 1NO Normal 1NC		B Bolt
MC22B	MC-22b		22H Hoist 2NO Normal 2NC		

- A : Metasol A Type
- B : Metasol B Type

ex)

MC65A-30-00-Q7-S-E	MC-65a AC380V 50/60Hz SCREW (Metasol) EXP
MC75A-30-22-H7-L-E	MC-75a AC100V 50/60Hz LUG 2a2b (Metasol) EXP
MC185A-30-22-FV-B-E	MC-185a AC100-240V 50/60Hz, DC100-220V 2a2b (Metasol) EXP
MC85A-40-00-M7-S-E	MC-85a AC220V 50/60Hz 4P (Metasol) EXP
MC800A-40-22-EV-B-E	MC-800a AC/DC200V 2a2b 4P (Metasol) EXP

Contactor relays

MR4		22L	B7
Product		Main contact	Coil voltage
MR4	MR-4	00	Coil code Table <i>*note) See page 23 for details</i>
MR6	MR-6	13	
MR8	MR-8	22	S Screw
		22L	
		44	L Lug
		44L	B Bolt

ex)

MR4-22-B7-E	MR-4 AC24V 50/60Hz 2a2b (Metasol) EXP
MR6-42-JD-E	MR-6 DC12V 4a2b (Metasol) EXP
MR8-44-MD-E	MR-8 DC220V 4a4b (Metasol) EXP

Thermal Overload Relay

MT-12		3H	0.1			
Rated current		Relay version		Relay setting current		
12	12AF	3H	Non-differential (3-heater)		0.1	0.1A
32	32AF		3K	Differential		⋮
63	63AF	3D		Class 20		800
95	95AF					
⋮	⋮					
800	800AF					

Enclosed Motor starters

MW22B		M	B
Product		Material	
MW6A	MW-9a	-	Iron
⋮	⋮		
MW100A	MW-100a		None
⋮			
Product		Material	
MW9B	MW-9b	M	Mold
⋮	⋮		
MW22B	MW-22b		Button

ex)	MW32aB-30-22-M7-21.5-3H-S-E	MW-32aB AC220V 50/60Hz SCREW 2a2b 21.5A 3H (Metasol) EXP
	MW32A-30-22-N5-34-3H-S-E	MW-32a AC415V 50Hz SCREW 2a2b 34A 3H (Metasol) EXP
	MW22BMB-11-Q7-19-SH-S-E	MW-22bMB AC380V 50/60Hz SCREW 1a1b 19A 3H (Metasol) EXP

Main Coil Voltage											
AC						DC		Semi-electric (AC)		Electric (AC/DC)	
50Hz		60Hz		50/60Hz				50/60Hz			
Coil Voltage(V)	code	Coil Voltage(V)	code	Coil Voltage(V)	code	Coil Voltage(V)	code	Coil Voltage(V)	code	Coil Voltage(V)	
24V	B5	24V	B6	24V	B7	12V	JD	100~120	HF	24 (AC24~25 50/60Hz, DC24)	
48V	E5	48V	E6	48V	E7	24V	BD	220~240	MU	48 (AC48~50 50/60Hz, DC24)	
110V	F5	110V	F6	110V	F7	48V	ED	265~347	OQ	24/48 (AC24~50 50/60Hz, DC100~110)	
220V	M5	220V	M6	220V	M7	110V	FD	380~440	OV	100/200 (AC100~240 50/60Hz, DC100~220)	
380V	Q5	380V	Q6	380V	Q7	125V	GD	440~575	S7	100/200 (AC100~240 50/60Hz, DC100~220)	
415V	N5	415V	N6	415V	N7	220V	MD				
440V	R5	440V	R6	440V	R7	240V	OD				

* See page 23 for details

Type numbering system

Optional Accessories

Auxiliary contact unit



Version		Contact composition	
UA-1	Side mount	11	1NO+1NC
AU-100		20	2NO
AU-100E		02	2NC
UA-2	Front mount(2P)	40	4NO
UA-4	Front mount(4P)	31	3NO+1NC
		22	2NO+2NC
		13	1NO+3NC
		04	4NC

Note) UA-2: 2NO, 1NO1NC, 2NC
 UA-4: 4NO, 3NO1NC, 4NC,
 2NO2NC, 1NO3NC,

Surge absorber



Product Composition	Voltage	
Varistor+RC	1	AC 24~48V
Varistor+RC	2	AC 100~125V
Varistor+RC	3	AC 200~240V
Varistor+RC	4	DC 24~48V
Varistor+RC	5	DC 100~125V
Varistor+RC	6	DC 200~220V
Varistor	11	AC/DC 24~48V
Varistor	12	AC/DC 100~125V
Varisto	13	AC/DC 200~240V
Varistor	14	AC/DC 380~440V
RC	22	AC 100~125V

Note) See page 82 for details.

Interlock unit



Product	Contact composition	
	02	2NC
	00	None

Wire kit for Interlocking



Product	Rated current	
	18	18AF
	22	22AF
	32	40AF
	63	65AF
	95	100AF

Separate mounting unit (For relay)



Product	Rated current	
	12	12AF
	32	32AF
	63	63AF
	95	95AF
	150	150AF

Remote reset unit (For relay)



Product	Cable Length	
	12	12AF
	32	32AF
	63	63AF



















Environment



Standards	IEC/EN 60947-1, IEC/EN 60947-4-1, UL508, K60947
Certifications	CE, UL, CCC
Rated insulation voltage (Ui)	1000V (6A~22A: 690V, 32A~800A: 1000V)
Rated impulse withstand voltage (Uimp)	8kV (6A~22A: 6kV, 32A~800A: 8kV)
Degree of protection	IP20 (Conforming to IEC60529)
Ambient air temperature	<p>Storage: -30°C ~ +65°C</p> <p>Operation: -5°C ~ +55°C (AC Type)</p> <p>-5°C ~ +40°C (MT, DC Type)</p> <p>-25°C ~ +60°C (MT refer to Graph)</p>
Operating altitude	3000m (8900ft)
Operating positions	
Shock resistance (1/2 sine wave =11ms)	<p>Opened: 8G</p> <p>Closed: 10G</p>
Vibration resistance (Conforming to IEC68-2-6) (5...300 Hz)	<p>Opened: 2G</p> <p>Closed: 4G</p>
Flame resistance	<p>Conforming to UL 94: V0</p> <p>Conforming to IEC 695-2-1: 960°C</p>

Connections

Connections

Wire type		Main Terminal Size							Torque		
			(AWG / mm ²)							mm(max)	[lb-in]
MC-6a/9a		M3.5	18~10 / 1~6	18~10 / 1~6	18~10 / 1~6			8.3	10	1.13	12
MC-12a			16~10 / 1.5~10	16~10 / 1.5~10	16~10 / 1.5~10						
MC-18a			16~8 / 1.5~10	16~8 / 1.5~10	16~8 / 1.5~10						
MC-9b		M4	18~10 / 1~6	18~10 / 1~6	18~10 / 1~6			9.6	20	2.25	23
MC-12b			18~10 / 1~6	16~10 / 1~6	16~10 / 1~6						
MC-18b			18~10 / 1~6	16~8 / 1.5~10	16~8 / 1.5~10						
MC-22b			18~10 / 1~6	14~8 / 2.5~10	14~8 / 2.5~10						
MC-32a		M5	18~10 / 1~6	12~8 / 2.5~10	12~8 / 2.5~10			12.8	35	4	41
MC-40a			18~10 / 1~6	8~6 / 10~16	8~6 / 10~16						
MC-50a		M6	-	10~4 / 6~25	10~4 / 6~25			14	35	4	41
MC-65a			-	8~3 / 10~35	8~3 / 10~35						
MC-75a		M8	-	8~2 / 10~35	8~2 / 10~35			17	45	5.1	52
MC-85a			-	8~1/0 / 10~50	8~1/0 / 10~50						
MC-100a			-	8~2/0 / 10~70	8~2/0 / 10~70						
MC-130a		M8	-	3~2/0 / 35~70	3~2/0 / 35~70			24.5	80	9.1	93
MC-150a			-	3~4/0 / 35~95	3~4/0 / 35~95						
MC-6~150a Aux./Coil		M4	20~14 / 0.5~2.5	18~12 / 0.75~2.5	18~12 / 0.75~2.5			7.6	10	1.13	12
MC-185a		M10	-	1~4/0 / 50~95	1~4/0 / 50~95			25	130	14.7	150
MC-225a			-	1/0~300 / 50~150	1/0~300 / 50~150						
MC-265a		M12	-	3/0~500 / 95~240	3/0~500 / 95~240			30	200	22.6	230
MC-330a			-	4/0~500 / 95~240	4/0~500 / 95~240						
MC-400a			-	350~700 / 185~185×2	350~700 / 185~185×2						
MC-500a		M16	-	350~800 / 185~240×2	350~800 / 185~240×2			40	500	26.5	270
MC-630a			-	600~2000	-						
MC-800a			-	1700~Busbar	-						
MC-185~800a Aux./Coil		M4	16~10 / 1.25~5.5	16~10 / 1.25~5.5	16~10 / 1.25~5.5			7.6	15	1.75	18
MC-1260a		M12	-	5mm×100mm×2ea	-			-	200	22.6	230
MC-1400a		M12	-	5mm×100mm×2ea	-			-	200	22.6	230
MC-1700a			-	5mm×100mm×3ea	-						
MC-2100a			-	5mm×100mm×4ea	-						

Coil code table

AC						DC		Semi-electric (AC)		Electric (AC/DC)	
50Hz		60Hz		50/60Hz		-		50/60Hz		-	
Coil voltage(V)	code	Coil voltage(V)	code	Coil voltage(V)	code	Coil voltage(V)	code	Coil voltage(V)	code	Coil voltage(V)	code
24	B5	24	B6	24	B7	12	JD	100-120	HF	24 (AC24-25 50/60Hz, DC24)	AV
32	C5	32	-	32	-	20	AD	220-240	MU	48 (AC48-50 50/60Hz, DC24)	BV
36	CB5	36	-	36	CB7	24	BD	300 (265-247)	OQ	24/48 (AC24-50 50/60Hz, DC24-48)	CV
42	D5	42	-	42	D7	30	PD	380-440	OV	100/100 (AC100-127 50/60Hz, DC100-110)	DV
48	E5	48	E6	48	E7	36	CD	500 (440-575)	S7	100/200 (AC100-240 50/60Hz, DC100-220)	FV
65	GE5	65	GE6	65	GE7	42	ID	100-120 (LED)	HFL	200/200 (AC200-240 50/60Hz, DC200-220)	EV
80	G5	80	-	80	-	48	ED	220-240 (LED)	MUL	300/400 (AC265-450 50/60Hz)	GV
100	H5	100	-	100	H7	60	ND	380-440 (LED)	QVL	AC 300 (AC265-347 50/60Hz)	HV
110	F5	110	F6	110	F7	72	SD			AC 400 (AC380-450 50/60Hz)	IV
100/110	-	100/110	-	100/110	HF7	80	KS			AC 500 (AC440-575 50/60Hz)	JV
115	FE5	115	FE6	115	FE7	100	HD				
110/120	-	110/120	-	110/120	HK7	110	FD				
120	K5	120	K6	120	K7	120	KD				
127	KB5	127	KB6	127	KB7	125	GD				
175	LC5	175	LC6	175	LC7	200	LD				
200	L5	200	L6	200	L7	220	MD				
200/208	-	200/208	-	200/208	LJ7	240	OD				
208	LB5	208	LB6	208	LB7	250	UD				
220	M5	220	M6	220	M7						
200/220	-	200/220	-	200/220	LM7						
220/230	-	220/230	-	220/230	MP7						
220/240	-	220/240	-	220/240	MU7						
220L	M5L	220L	M6L	220L	M7L						
230	P5	230	-	230	P7						
240	U5	240	U6	240	U7						
240W	U5W	240W	-	240W	-						
230/240	PU5	230/240	PU6	230/240	PU7						
240/277	-	240/277	-	240/277	UO7						
256	A5	256	A6	256	A7						
277	O5	277	O6	277	O7						
380	Q5	380	Q6	380	Q7						
400	V5	400	-	400	V7						
380/400	-	380/400	-	380/400	QV7						
415	N5	415	N6	415	N7						
440	R5	440	R6	440	R7						
400/440	-	400/440	-	400/440	VR7						
460	-	460	-	460	RW7						
480	W5	480	W6	480	-						
500	S5	500	-	500	S7						
550	X5	550	-	550	X7						
600	T5	600	T6	600	-						

Control coil characteristics



Frame size		18AF	22AF	40AF	65AF	100AF	150AF(A)	
Type		MC-6a	MC-9b	MC-32a	MC-50a	MC-75a	MC-130a	
		MC-9a	MC-12b	MC-40a	MC-65a	MC-85a	MC-150a	
		MC-12a	MC-18b		MD-30a	MC-100a		
		MC-18a	MC-22b			MD-60a		
		MR-4, 6, 8				MD-100a		
AC coil								
Control voltage	[Uc]						24, 48, 100-240	
50Hz	[V]	24, 32, 36, 42, 48, 80, 100, 110, 120, 220, 230, 240, 380, 400, 415, 440, 500, 550V					110-120, 220-240,	
60Hz	[V]	24, 48, 110, 120, 200, 208, 220, 230, 240, 277, 380, 440, 480, 600V					300, 380-440, 500V	
Voltage limit	[Uc]	85 ~110%						
Coil consumption at 20°C								
AC 220V	Inrush [VA]	70	70	90	110	240	110	
60Hz	Holding [VA]	9	9	9	13	17	18	
Heat dissipation [W]		2.3	2.3	2.7	2.8	5.4	2.7	
Operating time								
	Closing [ms]	15 ... 30	15 ... 30	15 ... 30	15 ... 30	15 ... 30	20 ... 40	
	Opening [ms]	4 ... 19	4 ... 19	4 ... 19	4 ... 19	10 ... 30	50 ... 70	
DC coil								
Control voltage	[Uc]	12, 20, 24, 48, 60, 80, 100, 110, 125, 200, 220, 250V					24, 48, 70-110, 100-220, 110, 220V	
Voltage limit	[Uc]	85~110%						
Coil consumption at 20°C								
DC 110V	Inrush [W]	6	6	9	9	18	213	
	Holding [W]	6	6	9	9	18	7.5	
Time constant (L/R) [ms]		28	28	28	65	75		
Operating time								
	Closing [ms]	40 ... 60	40 ... 60	50 ... 65	50 ... 65	100 ... 120	70 ... 80	
	Opening [ms]	4 ... 19	4 ... 19	4 ... 19	4 ... 19	10 ... 25	60 ... 70	

Note) Either semi-electronic coil(A) or electronic coil(B) can be chosen for MC-130a and MC-150a

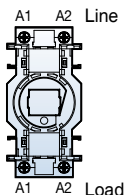

Note) A1(A2) in line side is internally connected to A1(A2) in load side.



Frame size		150AF(B)	225AF	400AF	800AF	1260AF	2100AF
Type		MC-130a	MC-185a	MC-265a	MC-500a	MC-1260a	MC-1400a
		MC-150a	MC-225a	MC-330a	MC-630a		MC-1700a
				MC-400a	MC-800a		MC-2100a
AC/DC common coil							
Control voltage	[Uc]						
	AC/DC	24/48	24/24	DC 24	-	-	-
	AC/DC		48/48	-	100/100	-	-
	AC/DC	100~240/100~220	100~240/100~220	100~240/100~220	200/200	100~240/100~220	100~240/100~220
	AC	-	300	300	300	-	-
	AC	-	400	400	400	-	-
	AC	-	500	500	500	-	-
Voltage limit	[Uc]	85~110% Note 1)					
Coil consumption at 20°C Note 2)							
AC 220V	Inrush [VA]	320	380	571	1000	1500	2500
50/60Hz	Holding [VA]	10	11.6	14	29	24	50
Heat dissipation [W]		4.5	4.7	5	7.8		8.7
Operating time							
	Closing [ms]	70	70	55	75	75	80
	Opening [ms]	70	70	55	75	75	70

Note) 1. Voltage limit for DC 24V coil is 75~110%.

2. Operating time for DC 24V coil is 90ms.

3. Either semi-electronic coil(A) or electronic coil(B) can be chosen for MC-130a and MC-150a

Marking

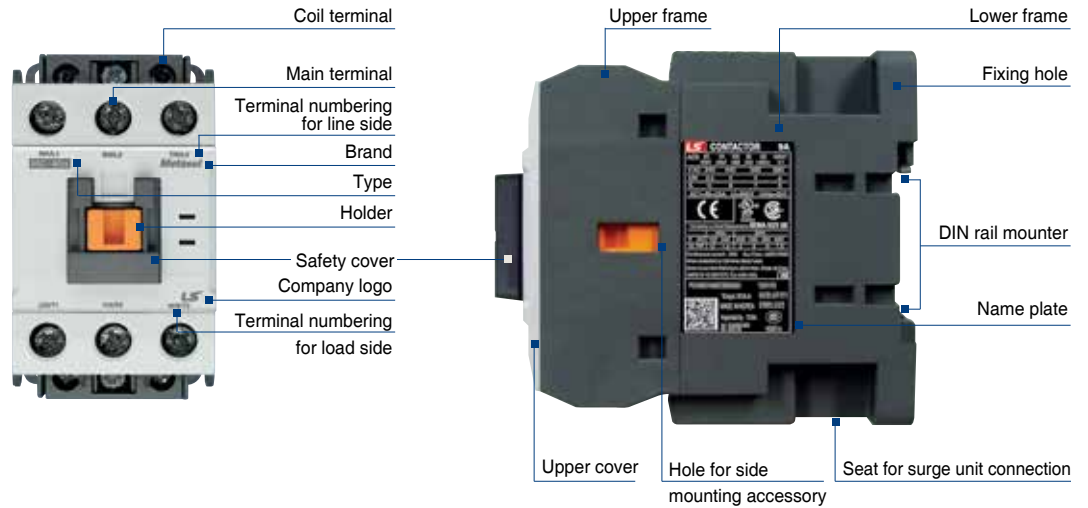

<p>Company logo</p> <p>CE marking</p> <p>UL size</p> <p>Wire size</p> <p>Country of origin</p> <p>Bar code</p>		<p>Type</p> <p>Product name</p> <p>Rating</p> <p>UL, CSA rating</p> <p>A, B : Metasol MC S : Susol MC</p> <p>Date of manufacture</p> <p>Certification (Domestic use only)</p>
--	--	---

Internal structure

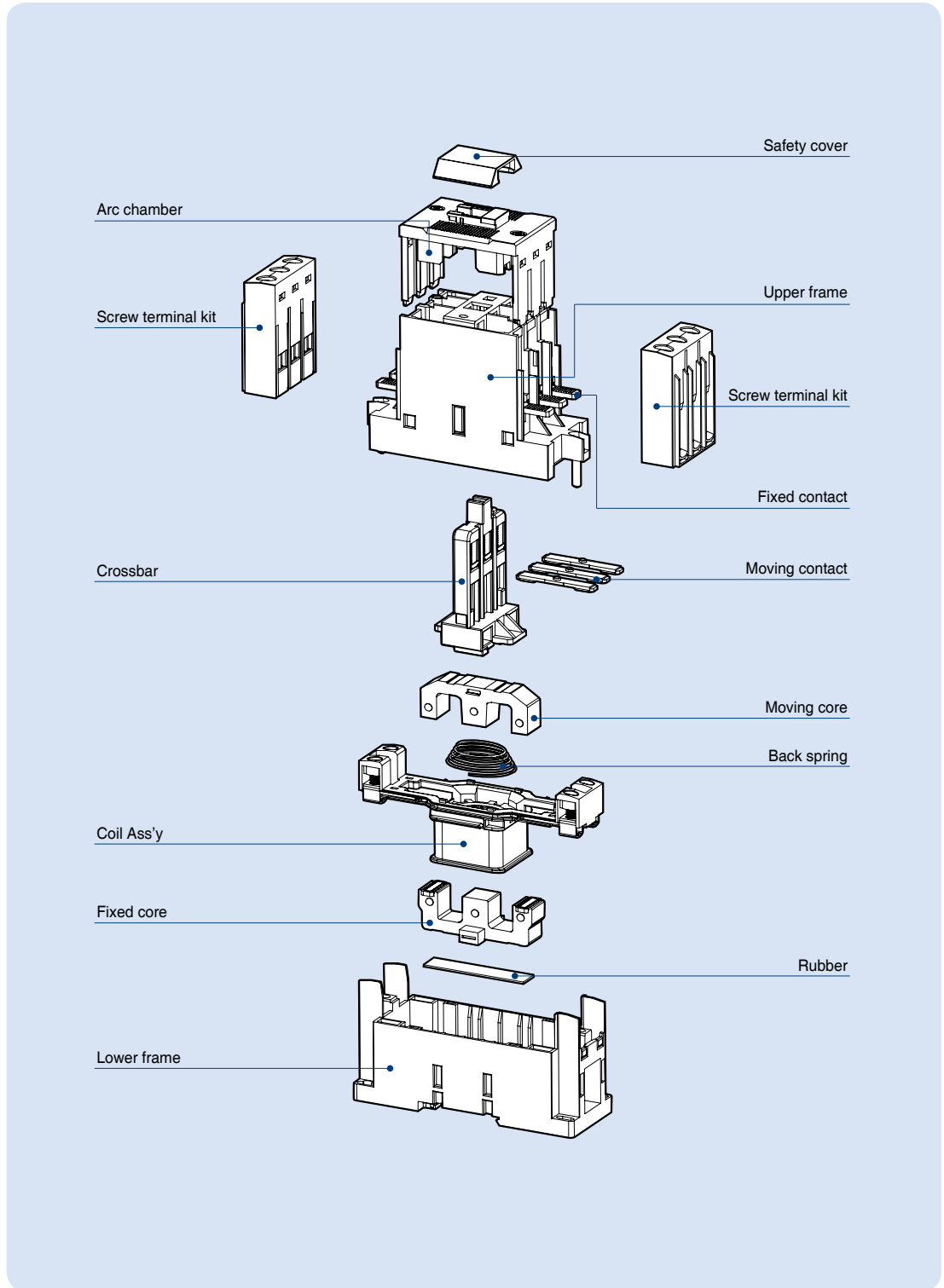

Contactors (18AF)

Description

- 3-pole(NO) main contact
- Finger proof design
- DIN rail or screw mountable
- AC or DC control in different physical size
- Front/side mountable accessories available
- Direct mountable overload relay available Rating
- 1NO or 1NC Auxiliary contact built-in as standard.
- Degree of protection: IP20

Rating



MC-18a

Contactor type			MC-6a		MC-9a		MC-12a		MC-18a		
			kW	A	kW	A	kW	A	kW	A	
AC duty	AC3	200/240V	2.2	9	2.2	11	3.5	13	4.5	18	
		380/440V	3	7	4	9	5.5	12	7.5	18	
		500/550V	3	6	4	7	7.5	12	7.5	13	
		690V	3	4	4	5	7.5	9	7.5	9	
	AC4	200/240V	1.5	7	1.5	8	2.2	11	3.7	16	
		380/440V	2.2	5	2.2	6	4	9	4	11	
	AC1		-	25	-	25	-	25	-	32	
	DC1 duty (L/R=1ms)	2-pole	24V	-	10	-	10	-	12	-	18
			in series	48V	-	10	-	10	-	12	-
110V			-	6	-	6	-	10	-	13	
3-pole		24V	-	10	-	10	-	12	-	18	
		in series	48V	-	10	-	10	-	12	-	18
		110V	-	8	-	8	-	12	-	18	
DC2, 4 duty (L/R=15ms)	2-pole	24V	-	8	-	8	-	12	-	12	
		in series	48V	-	4	-	4	-	6	-	6
		110V	-	2.5	-	2.5	-	4	-	4	
	3-pole	24V	-	8	-	8	-	12	-	12	
		in series	48V	-	6	-	6	-	10	-	10
		110V	-	4	-	4	-	8	-	8	
Directly mountable Overload relay			MT-12								
Conductor size (solid, stranded)	AWG		18~10		16~10		16~8		14~8		
	(the max. number of conduct: 2) mm ²		1~4		1.5~4		1.5~10		2.5~10		
Conductor type			65/75°C Cu-wire only								

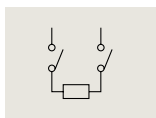

2pole for DC contact

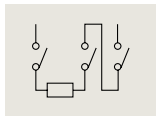

3pole for DC contact



Coil voltage

AC	50Hz	24, 32, 36, 42, 48, 80, 100, 110, 120, 220, 230, 240, 380, 400, 415, 440, 500, 550V
	60Hz	24, 48, 110, 120, 200, 208, 220, 230, 240, 277, 380, 440, 480, 600V
DC	DC	12, 20, 24, 48, 60, 80, 100, 110, 125, 200, 220, 250V

Certification

- CE(IEC)
- UL508
- CCC

* Please be cautious for wiring control power cable, especially "+" (Positive) and "-" (Negative) polarity should be correctly considered.

Accessories

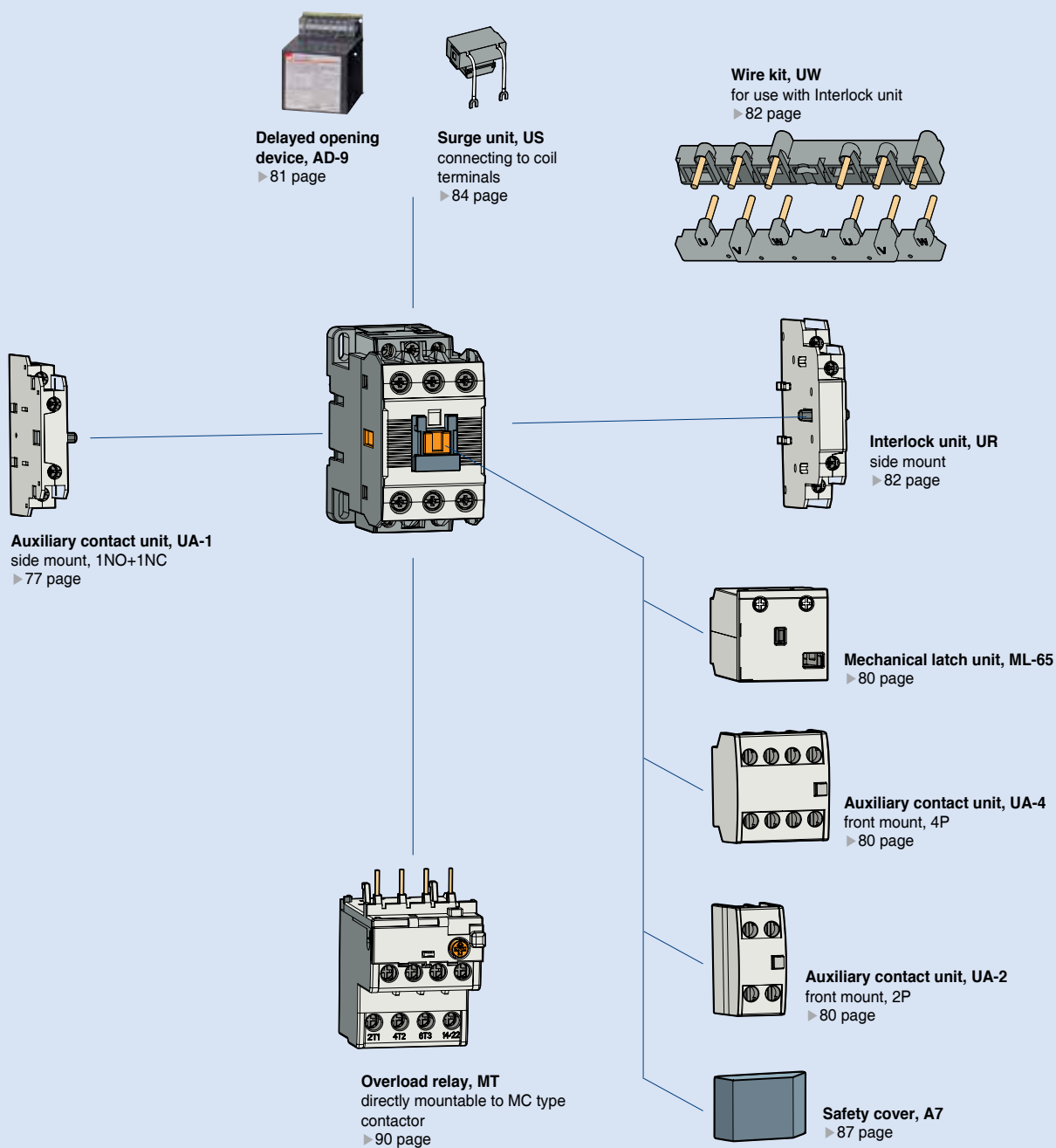

Contactors (22AF)

Description

- 3-pole(NO) main contact
- Finger proof design
- DIN rail or screw mountable
- AC or DC control in different physical size
- Front/side mountable accessories available
- Direct mountable overload relay available Rating
- 1NO1NC Auxiliary contact built-in as standard.
- UA-1 is available on only left side
- Degree of protection: IP20

Rating



MC-22b

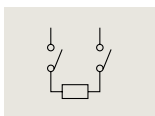

2pole for DC contact

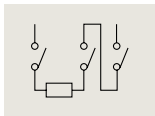

3pole for DC contact

Contactor type			MC-9b		MC-12b		MC-18b		MC-22b		
			kW	A	kW	A	kW	A	kW	A	
AC duty	AC3	200/240V	2.2	11	3.5	13	4.5	18	5.5	22	
		380/440V	4	9	5.5	12	7.5	18	11	22	
		500/550V	4	7	7.5	12	7.5	13	15	20	
		690V	4	6	7.5	9	7.5	9	15	18	
	AC4	200/240V	1.5	8	2.2	11	3.7	16	3.7	18	
		380/440V	2.2	6	4	9	4	11	5.5	13	
	AC1		-	25	-	25	-	32	-	40	
DC1 duty (L/R=1ms)	2-pole	24V	-	10	-	12	-	18	-	20	
		in series	48V	-	10	-	12	-	18	-	20
		110V	-	6	-	10	-	13	-	15	
	3-pole	24V	-	10	-	12	-	18	-	20	
		in series	48V	-	10	-	12	-	18	-	20
		110V	-	8	-	12	-	18	-	20	
DC 2,4 duty (L/R=15ms)	2-pole	24V	-	8	-	12	-	12	-	20	
		in series	48V	-	4	-	6	-	6	-	15
		110V	-	2.5	-	4	-	4	-	8	
	3-pole	24V	-	8	-	12	-	12	-	20	
		in series	48V	-	6	-	10	-	10	-	20
		110V	-	4	-	8	-	8	-	15	
Directly mountable Overload relay			MT-32								
Conductor size (solid, stranded)	AWG		16~10		16~8		14~8		14~8		
	(the max. number of conducts: 2) mm ²		1.5~4		1.5~10		2.5~10		2.5~10		
Conductor type			65/75°C Cu-wire only								



Coil voltage

AC	50Hz	24, 32, 36, 42, 48, 80, 100, 110, 120, 220, 230, 240, 380, 400, 415, 440, 500, 550V
	60Hz	24, 48, 110, 120, 200, 208, 220, 230, 240, 277, 380, 440, 480, 600V
DC	DC	12, 20, 24, 48, 60, 80, 100, 110, 125, 200, 220, 250V

Certification

- CE(IEC)
- UL508
- CCC

* Please be cautious for wiring control power cable, especially "+" (Positive) and "-" (Negative) polarity should be correctly considered.

Accessories

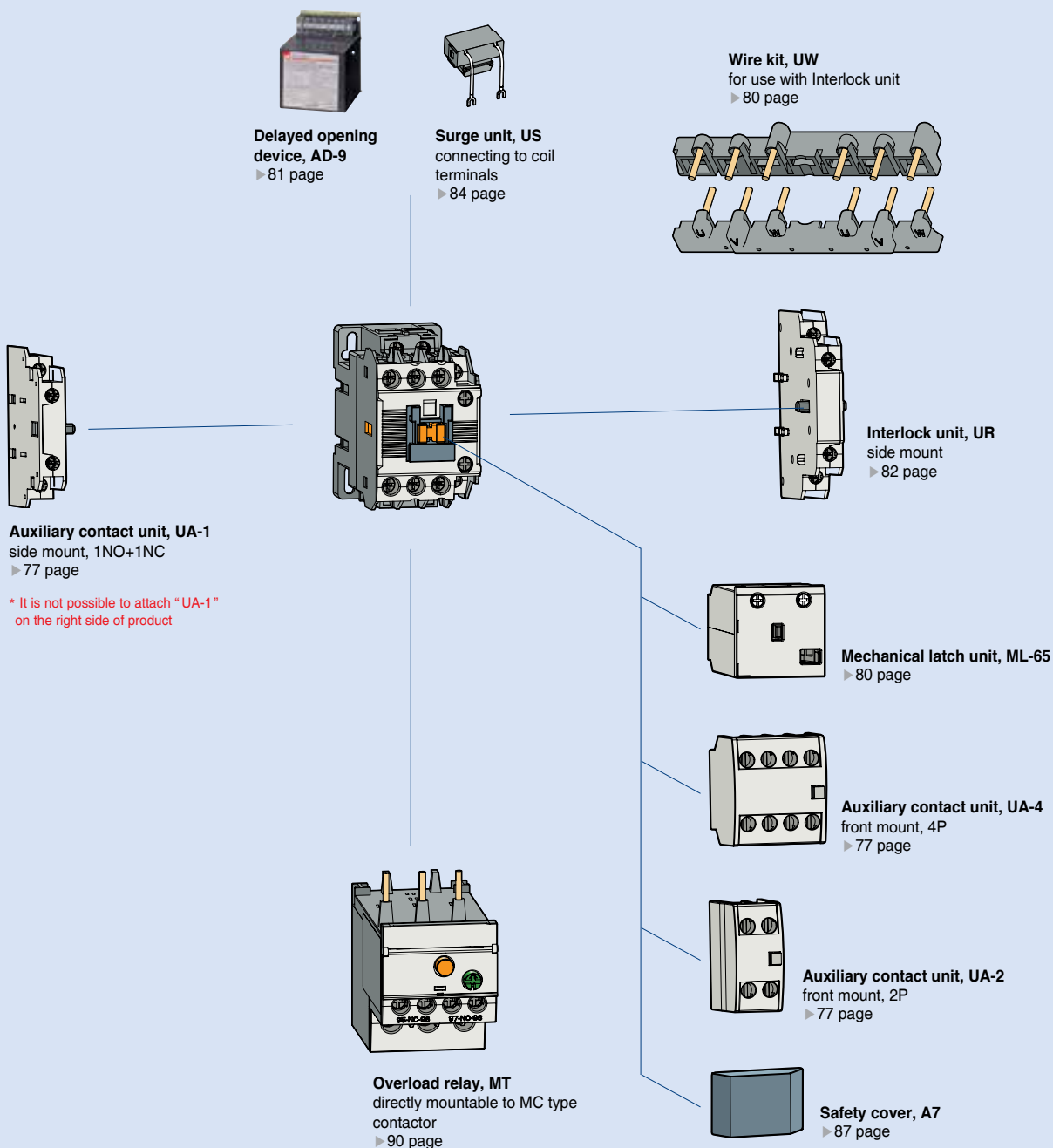

Contactors (40AF)

Description

- 3-pole(NO) main contact
- Finger proof design
- DIN rail or screw mountable
- AC or DC control in different physical size
- Front/side mountable accessories available
- Direct mountable overload relay available Rating
- 2NO2NC Auxiliary contact built-in is possible as standard
- Degree of protection: IP20

Rating



MC-40a

Contactor type			MC-32a		MC-40a	
			kW	A	kW	A
AC duty	AC3	200/240V	7.5	32	11	40
		380/440V	15	32	18.5	40
		500/550V	18.5	28	22	32
		690V	18.5	20	22	23
		1000V	22	17	22	17
	AC4	200/240V	4.5	20	5.5	25
		380/440V	7.5	17	11	24
	AC1		-	50	-	60
	DC1 (L/R=1ms)	2-pole	24V	-	25	-
in series		48V	-	25	-	35
		110V	-	25	-	25
3-pole		24V	-	25	-	35
		in series	48V	-	25	-
in series		110V	-	25	-	35
DC2,4 (L/R=15ms)	2-pole	24V	-	25	-	35
	in series	48V	-	20	-	20
		110V	-	10	-	10
	3-pole	24V	-	25	-	35
		in series	48V	-	25	-
	in series	110V	-	20	-	20
Directly mountable Overload relay			MT-32			
Conductor size (solid, stranded)		AWG	12~8		8~6	
(the max. number of conduct: 2)		mm ²	2.5~10		10~16	
Conductor type			65/75°C Cu-wire only			

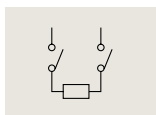

2pole for DC contact

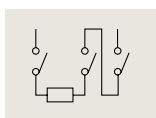

3pole for DC contact



Coil voltage

AC	50Hz	24, 32, 36, 42, 48, 80, 100, 110, 120, 220, 230, 240, 380, 400, 415, 440, 500, 550V
	60Hz	24, 48, 110, 120, 200, 208, 220, 230, 240, 277, 380, 440, 480, 600V
DC	DC	12, 20, 24, 48, 60, 80, 100, 110, 125, 200, 220, 250V

Certification

- CE(IEC)
- UL508
- CCC

* Please be cautious for wiring control power cable, especially "+" (Positive) and "-" (Negative) polarity should be correctly considered.

Accessories

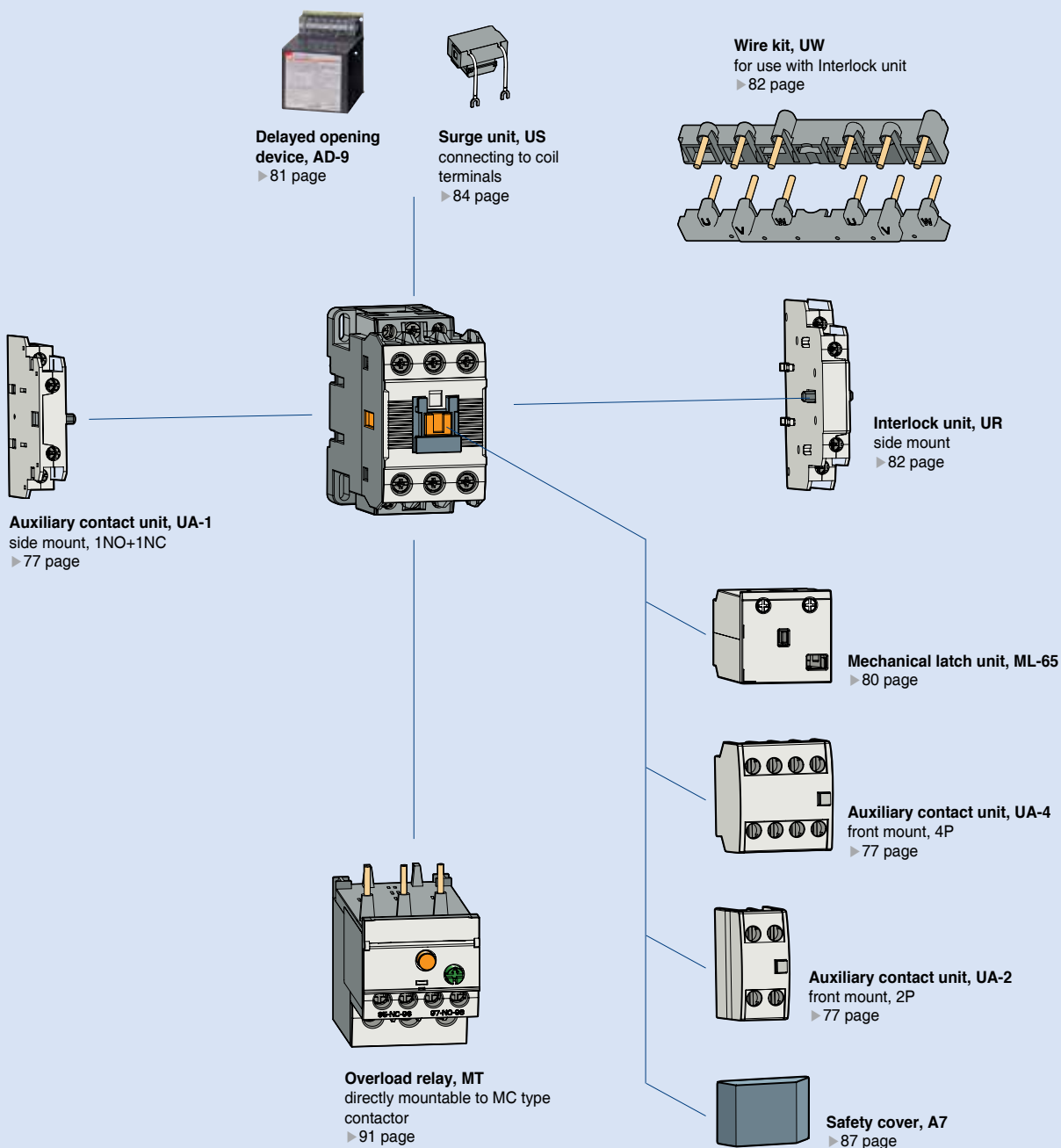

Contactors (65AF)

Description

- 3-pole(NO) main contact
- Finger proof design
- DIN rail or screw mountable
- Both screw and Box terminal (lug) type are available
- AC or DC control in different physical size
- Front/side mountable accessories available
- Direct mountable overload relay available rating
- 2NO2NC Auxiliary contact built-in is possible as standard
- Degree of protection: IP20

Rating



MC-65a

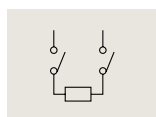

2pole for DC contact

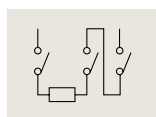

3pole for DC contact

Contactor type			MC-50a		MC-65a	
			kW	A	kW	A
AC duty	AC3	200/240V	15	55	18.5	65
		380/440V	22	50	30	65
		500/550V	30	43	33	60
		690V	30	28	33	35
		1000V	30	23	30	23
	AC4	200/240V	7.5	35	11	50
		380/440V	15	32	22	47
	AC1		-	70	-	100
	DC1 duty (L/R=1ms)	2-pole	24V	-	70	-
in series		48V	-	70	-	70
		110V	-	35	-	35
3-pole		24V	-	50	-	65
		in series	48V	-	50	-
in series		110V	-	50	-	65
DC2, 4 duty (L/R=15ms)	2-pole	24V	-	45	-	45
	in series	48V	-	25	-	25
		110V	-	15	-	15
	3-pole	24V	-	50	-	50
		in series	48V	-	35	-
	in series	110V	-	30	-	30
Directly mountable Overload relay			MT-63			
Conductor size (solid, stranded) (the max. number of conductors: 2)		AWG	10~4		8~3	
		mm ²	6~25		10~35	
Conductor type			65/75°C Cu-wire only			



Coil voltage

AC	50Hz	24, 32, 36, 42, 48, 80, 100, 110, 120, 220, 230, 240, 380, 400, 415, 440, 500, 550V
	60Hz	24, 48, 110, 120, 200, 208, 220, 230, 240, 277, 380, 440, 480, 600V
DC	DC	12, 20, 24, 48, 60, 80, 100, 110, 125, 200, 220, 250V

* Please be cautious for wiring control power cable, especially "+" (Positive) and "-" (Negative) polarity should be correctly considered.

Certification

- CE(IEC)
- UL508
- CCC

Accessories



Delayed opening device, AD-50
▶ 81 page



Surge unit, US
connecting to coil terminals
▶ 84 page

Wire kit, UW
for use with Interlock unit
▶ 82 page

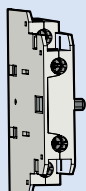
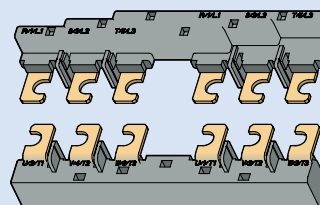

Auxiliary contact unit, UA-1
side mount, 1NO+1NC
▶ 77 page

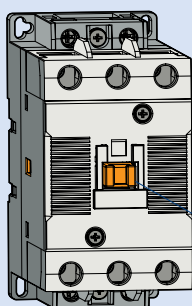

Interlock unit, UR
side mount
▶ 82 page

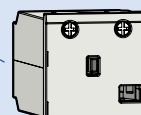

Mechanical latch unit, ML-65
▶ 80 page

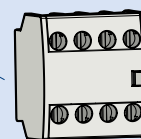

Auxiliary contact unit, UA-4
front mount, 4P
▶ 77 page



Auxiliary contact unit, UA-2
front mount, 2P
▶ 77 page

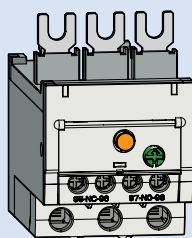

Overload relay, MT
directly mountable to MC type
contactor
▶ 91 page



Safety cover, A7
▶ 87 page

Contactors (100AF)

Description

- 3-pole(NO) main contact
- Finger proof design
- DIN rail or screw mountable
- Both screw and Box terminal (lug) type are available
- AC or DC control in different physical size
- Front/side mountable accessories available
- Direct mountable overload relay available Rating
- 2NO2NC Auxiliary contact built-in is possible as standard
- Degree of protection: IP20

Rating



MC-100a

Contactor type			MC-75a		MC-85a		MC-100a	
			kW	A	kW	A	kW	A
AC duty	AC3	200/240V	22	75	25	85	30	105
		380/440V	37	75	45	85	55	105
		500/550V	37	64	45	75	55	85
		690V	37	42	45	45	45	65
		1000V	37	28	37	28	37	28
	AC4	200/240V	13	55	15	65	19	80
		380/440V	25	52	30	62	37	75
	AC1		-	110	-	135	-	160
	DC1 duty (L/R=1ms)	2-pole	24V	-	75	-	80	-
in series		48V	-	65	-	65	-	100
		110V	-	50	-	50	-	80
3-pole		24V	-	75	-	80	-	100
in series		48V	-	75	-	80	-	100
		110V	-	75	-	80	-	100
DC2, 4 duty (L/R=15ms)	2-pole	24V	-	65	-	65	-	100
	in series	48V	-	40	-	40	-	60
		110V	-	20	-	20	-	40
	3-pole	24V	-	80	-	80	-	100
	in series	48V	-	60	-	60	-	90
		110V	-	50	-	50	-	80
Directly mountable Overload relay			MT-95					
Conductor size (solid, stranded)	AWG		8~2		8~0		8~00	
	(the max. number of conductors: 2)	mm ²	10~35		10~50		10~70	
Conductor type			65/75°C Cu-wire only					

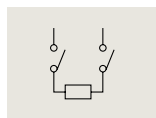

2pole for DC contact

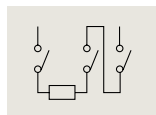

3pole for DC contact



Coil voltage

AC	50Hz	24, 32, 36, 42, 48, 80, 100, 110, 120, 220, 230, 240, 380, 400, 415, 440, 500, 550V
	60Hz	24, 48, 110, 120, 200, 208, 220, 230, 240, 277, 380, 440, 480, 600V
DC	DC	12, 20, 24, 48, 60, 80, 100, 110, 125, 200, 220, 250V

* Please be cautious for wiring control power cable, especially "+" (Positive) and "-" (Negative) polarity should be correctly considered.

Certification

- CE(IEC)
- UL508
- CCC

Accessories

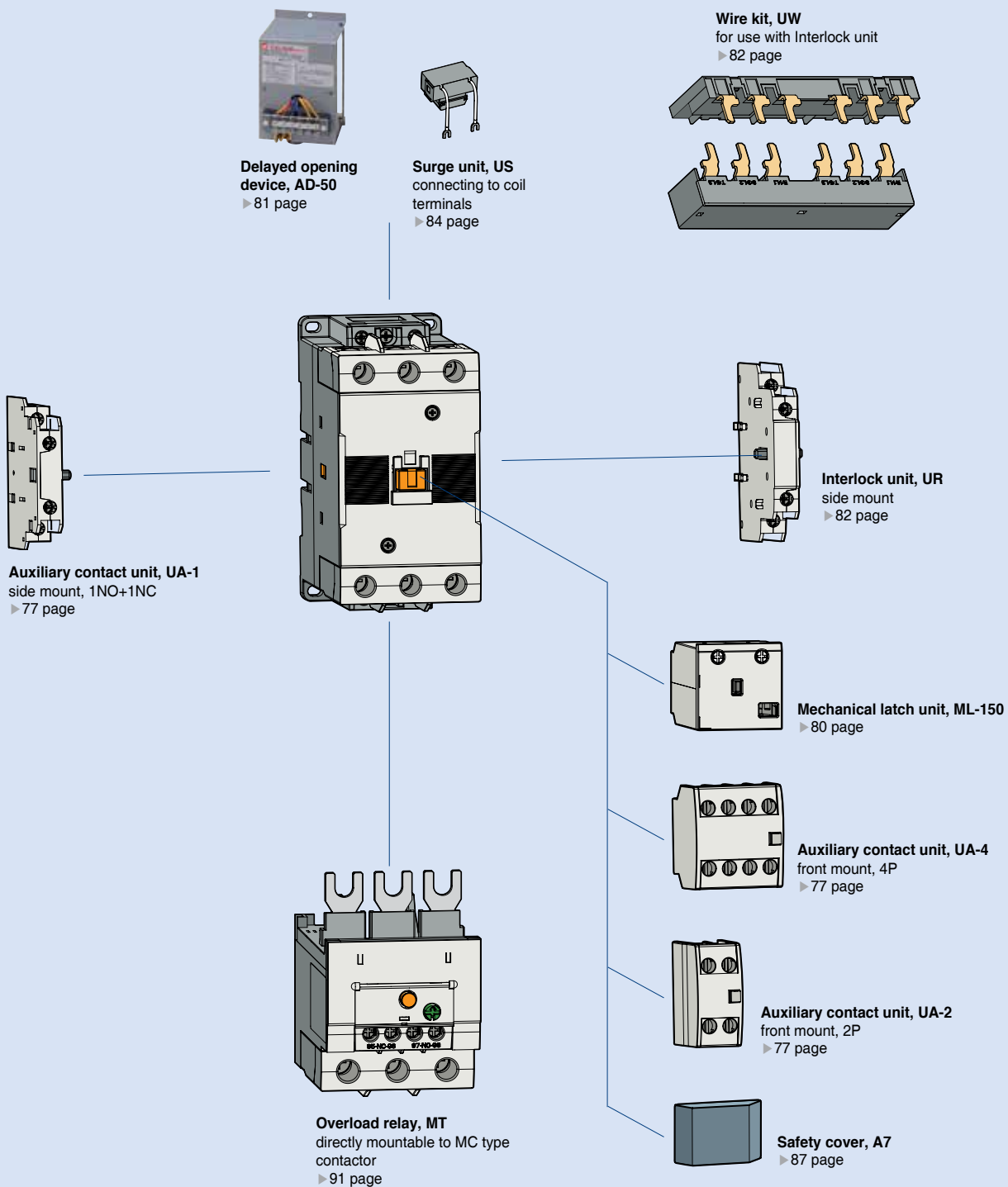

Contactors (150AF)

Description

- 3-pole(NO) main contact
- Finger proof design
- DIN rail or screw mountable
- Both screw and Box terminal (lug) type are available
- AC or DC control in the same physical size
- Front/side mountable accessories available
- Direct mountable overload relay available
- 2NO2NC Auxiliary contact built-in is possible as standard
- Degree of protection: IP20

Rating



MC-150a

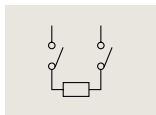

2pole for DC contact

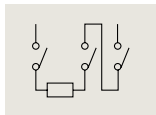

3pole for DC contact

Contactor type			MC-130a		MC-150a		
			kW	A	kW	A	
AC duty	AC3	200/240V	37	130	45	150	
		380/440V	60	130	75	150	
		500/550V	60	90	70	100	
		690V	55	60	55	60	
		1000V	75	53	75	53	
	AC4	200/240V	22	93	30	120	
		380/440V	45	90	55	110	
	AC1		-	160	-	210	
DC1 duty (L/R=1ms)	2-pole	24V	-	120	-	150	
		in series	48V	-	100	-	120
			110V	-	80	-	100
	3-pole	24V	-	120	-	150	
		in series	48V	-	120	-	150
			110V	-	100	-	150
DC2,4 duty (L/R=15ms)	2-pole	24V	-	120	-	150	
		in series	48V	-	60	-	100
			110V	-	40	-	80
	3-pole	24V	-	120	-	150	
		in series	48V	-	90	-	130
			110V	-	80	-	120
Directly mountable Overload relay			MT-150				
Conductor size (solid, stranded)		AWG	3-00		3-4/0		
(the max. number of conduct: 2)		mm ²	35~70		35~95		
Conductor type			65/75°C Cu-wire only				



Coil voltage

AC/DC	100~240 / 100~220
AC	50/60Hz 24, 48, 100~240, 110~120, 220~240, 300, 380~440, 500V
DC	DC 24, 48, 70~110, 100~220, 110, 220V

Certification
• CE(IEC)
• UL508
• CCC

* Please be cautious for wiring control power cable, especially "+" (Positive) and "-" (Negative) polarity should be correctly considered.

Accessories



Delayed opening device, AD-100
▶ 81 page

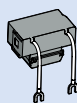

Surge unit, US
connecting to coil terminals
▶ 84 page

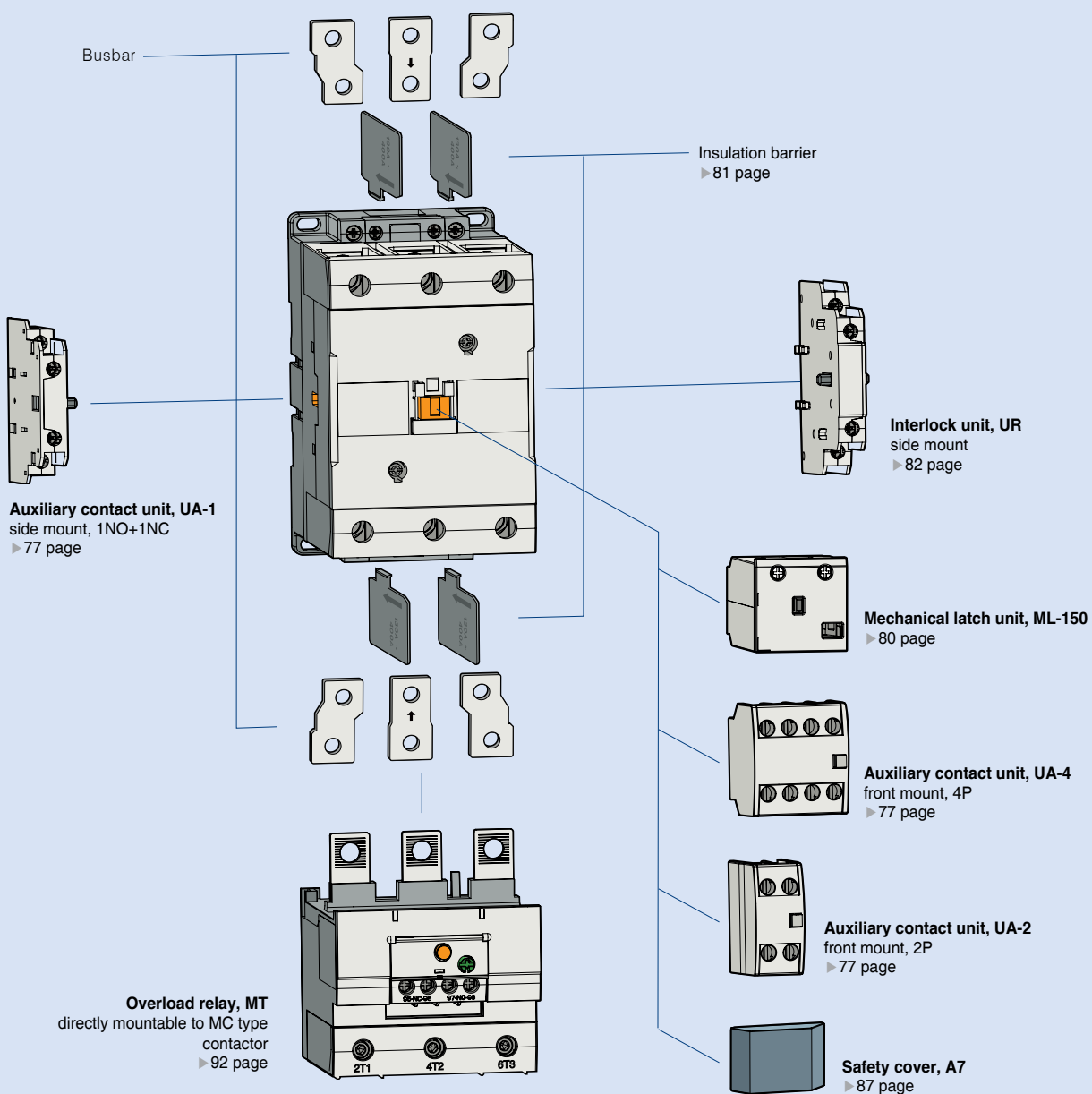

Contactors (225AF)

Description

- 3-pole main contact
- AC/DC common use coil built
- Wide coil operation voltage
- Screw mountable
- 2NO+2NC Auxiliary contacts built-in as standard
- Top/side mountable accessories available
- Direct mountable overload relays available
- Degree of protection: IP20

Rating



MC-225a

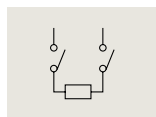

2pole for DC contact

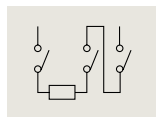

3pole for DC contact

Contactor type			MC-185a		MC-225a		
			kW	A	kW	A	
AC duty	AC3	200/240V	55	185	75	225	
		380/440V	90	185	132	225	
		500/550V	110	180	132	200	
		690V	110	120	140	150	
		1000V	132	90	132	90	
	AC4	200/240V	37	150	45	180	
		380/440V	75	150	90	180	
	AC1		-	230	-	275	
	DC1 duty (L/R=1ms)	2-pole	24V	-	180	-	220
in series			48V	-	180	-	180
110V			-	150	-	150	
3-pole		24V	-	180	-	220	
		in series	48V	-	180	-	220
		110V	-	180	-	220	
DC2, 4 duty (L/R=15ms)	2-pole	24V	-	180	-	220	
		in series	48V	-	150	-	150
		110V	-	120	-	120	
	3-pole	24V	-	180	-	220	
		in series	48V	-	180	-	220
		110V	-	150	-	150	
Directly mountable Overload relay			MT-225				
Conductor size (solid, stranded) (the max. number of conductors: 2)		AWG	1-4/0		0-300		
		mm ²	50-95		50-150		
Conductor type			75°C Cu stranded wire				



Coil voltage, AC/DC common

Nominal(ordering) voltage	AC 50/60Hz	DC
24V	24 - 25V	24V
48V	48 - 50V	48V
100/200V	100 - 240V	100 - 220V
300V	265 - 347V	-
400V	380 - 450V	-
500V	440 - 575V	-

Certification

- CE(IEC)
- UL508
- CCC

Accessories



AD-100
Delayed opening device
► 81 page

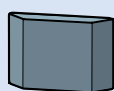

Safety cover, A7
► 87 page



AP-220
Terminal cover
► 81 page



AI-180
Insulation barrier
► 81 page



AU-100, 100E
Auxiliary contact unit
side mount, 1NO+1NC
► 78 page



AR-180
Interlock unit
side mount
► 83 page



MT-225
Overload relay
directly mountable to the contactor
Current range 65-240A
► 93 page

Contactors (400AF)

Description

- 3-pole main contact
- AC/DC common use coil built
- Wide coil operation voltage
- Screw mountable
- 2NO+2NC Auxiliary contacts built-in as standard
- Top/side mountable accessories available
- Direct mountable overload relays available
- Degree of protection: IP20

Rating



MC-400a

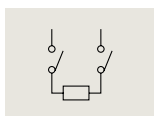

2pole for DC contact

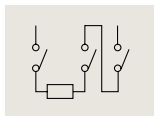

3pole for DC contact

Contactor type			MC-265a		MC-330a		MC-400a		
			kW	A	kW	A	kW	A	
AC duty	AC3	200/240V	80	265	90	330	125	400	
		380/440V	147	265	160	330	200	400	
		500/550V	147	225	160	250	225	350	
		690V	160	185	200	220	250	300	
		1000V	147	105	147	105	147	105	
	AC4	200/240V	50	200	55	220	75	300	
		380/440V	102	200	110	220	150	300	
	AC1		-	300	-	350	-	450	
	DC1 duty (L/R=1ms)	2-pole	24V	-	220	-	300	-	400
in series			48V	-	180	-	240	-	240
110V			-	150	-	200	-	200	
3-pole		24V	-	220	-	300	-	400	
		in series	48V	-	220	-	300	-	400
		110V	-	220	-	300	-	400	
DC2, 4 duty (L/R=15ms)	2-pole	24V	-	220	-	300	-	400	
		in series	48V	-	150	-	200	-	200
		110V	-	120	-	150	-	150	
	3-pole	24V	-	220	-	300	-	400	
		in series	48V	-	220	-	280	-	280
		110V	-	150	-	200	-	200	
Directly mountable Overload relay			MT-400						
Conductor size (solid, stranded)		AWG	3/0-500		4/0-500		350-700		
		mm ²	95-240		95-240		185-370		
Conductor type			75°C Cu stranded wire						



Coil voltage, AC/DC common

Nominal(ordering) voltage	AC 50/60Hz	DC
100/200V	100 - 240V	100 - 220V
300V	265 - 347V	-
400V	380 - 450V	-
500V	440 - 575V	-

Certification

- CE(IEC)
- UL508
- CCC

Accessories



AD-300
Delayed opening device
▶ 81 page

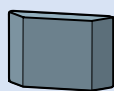

Safety cover, A7
▶ 87 page



AP-400
Terminal cover
▶ 79 page



AI-180
Insulation barrier
▶ 81 page

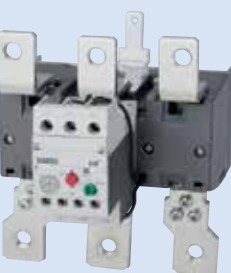

MT-400
Overload relay
directly mountable to the contactor
Current range 85-400A
▶ 93 page



AU-100, 100E
Auxiliary contact unit
side mount, 1NO+1NC
▶ 78 page



AR-180
Interlock unit
side mount
▶ 83 page

Contactors (800AF)

Description

- 3-pole main contact
- AC/DC common use coil built
- Wide coil operation voltage
- Screw mountable
- 2NO+2NC Auxiliary contacts built-in as standard
- Top/side mountable accessories available
- Overload relays available
- Degree of protection: IP20

Rating



MC-800a

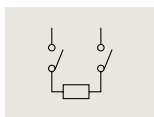

2pole for DC contact

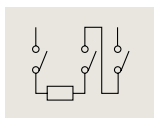

3pole for DC contact

Contactor type			MC-500a		MC-630a		MC-800a		
			kW	A	kW	A	kW	A	
AC duty	AC3	200/240V	147	500	190	630	220	800	
		380/440V	265	500	330	630	440	800	
		500/550V	265	400	330	500	500	720	
		690V	300	380	400	420	500	630	
		1000V	280	220	280	220	280	220	
	AC4	200/240V	90	350	110	400	160	630	
		380/440V	176	350	200	400	300	630	
	AC1		-	580	-	660	-	900	
DC1 duty (L/R=1ms)	2-pole	24V	-	400	-	630	-	800	
		in series	48V	-	240	-	630	-	800
		110V	-	200	-	630	-	630	
	3-pole	24V	-	400	-	630	-	800	
		in series	48V	-	400	-	630	-	800
		110V	-	400	-	630	-	800	
DC2, 4 duty (L/R=15ms)	2-pole	24V	-	400	-	630	-	800	
		in series	48V	-	200	-	630	-	630
		110V	-	150	-	630	-	630	
	3-pole	24V	-	400	-	630	-	800	
		in series	48V	-	280	-	630	-	630
		110V	-	200	-	630	-	630	
Directly mountable Overload relay			MT-800						
Conductor size (solid, stranded)		AWG	350~800		600~2000		1700~Busbar		
		mm ²	185~480		-		-		
Conductor type			75°C Cu stranded wire						



Coil voltage, AC/DC common

Nominal(ordering) voltage	AC 50/60Hz	DC
100V	100 - 127V	100 - 110V
200V	200 - 240V	200 - 220V
300V	265 - 347V	-
400V	380 - 450V	-
500V	440 - 575V	-

Certification

- CE(IEC)
- UL508
- CCC

Accessories



AD-600
Delayed opening device
▶ 81 page

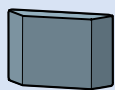

Safety cover, A7
▶ 87 page



AP-800
Terminal cover
▶ 81 page



AI-600
Insulation barrier
▶ 81 page



AU-100, 100E
Auxiliary contact unit
side mount, 1NO+1NC
▶ 78 page



AR-600
Interlock unit
side mount
▶ 83 page



MT-800
Overload relay
directly mountable to the contactor
Current range 200-800A
▶ 93 page

Contactors (1260AF)

Description

- 3-pole main contact
- AC/DC common use coil built
- Wide coil operation voltage
- Screw mountable
- 2NO+2NC Auxiliary contacts built-in as standard
- Top/side mountable accessories available
- Overload relays available
- Degree of protection: IP20



MC-1260a

Rating

Contactor type			MC-1260a	
			kW	A
AC duty	AC3	200/240V	-	-
		380/440V	900	1450
		500/550V	-	-
		690V	-	-
		1000V	-	-
	AC1		-	1260
Conductor size (solid, stranded)	Bubar	5mm×100mm×2ea		
Conductor type		Busbar		



Coil voltage, AC/DC common

Nominal(ordering) voltage	AC 50/60Hz	DC
100V / 200V	100 - 240V	100 - 220V

Certification
<ul style="list-style-type: none"> • CE(IEC) • UL, UL/cUL

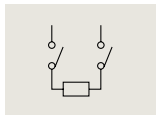

2pole for DC contact

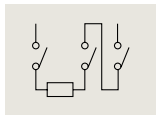

3pole for DC contact

Accessories



AI-800
Insulation barrier
► 81 page



AU-100, 100E
Auxiliary contact unit
side mount, 1NO+1NC
► 78 page

Contactors (2100AF)

Description

- 3-pole main contact
- AC/DC common use coil built
- Wide coil operation voltage
- Screw mountable
- 2NO+2NC Auxiliary contacts built-in as standard
- Top/side mountable accessories available
- Overload relays available
- Degree of protection: IP20

Rating



MC-2100a

Contactor type			MC-1400a		MC-1700a		MC-2100a	
			kW	A	kW	A	kW	A
AC duty	AC3	200/240V	290	860	310	1050	-	-
		380/440V	550	860	700	1050	900	1450
		500/550V	-	-	-	-	-	-
		690V	800	800	1000	950	-	-
		1000V	-	-	-	-	-	-
	AC1		-	1400	-	1700	-	2100
Conductor size (solid, stranded)	Busbar		5mm × 100mm × 2ea		5mm × 100mm × 2ea		5mm × 100mm × 2ea	
Conductor type			Busbar					



Coil voltage, AC/DC common

Nominal (ordering) voltage	AC 50/60Hz	DC
100V / 200V	100 - 240V	100 - 220V

Certification
<ul style="list-style-type: none"> • CE(IEC) • UL60947-4-1 • CCC

Accessories



AI-2100
Insulation barrier
► 81 page



AU-100, 100E
Auxiliary contact unit
side mount, 1NO+1NC
► 78 page

Motor starters

Description

- Opened direct motor starter
- 3-pole(NO) main contact
- Finger proof design
- DIN rail or screw mountable
- AC or DC control contactor selectable
- Front/side mountable accessories available
- Overload relay is directly mounted to the contactor
- Degree of protection: IP20



Rating

Starter type	18AF				22AF			
	MS-6a	MS-9a	MS-12a	MS-18a	MS-9b	MS-12b	MS-18b	MS-22b
Number of poles	3				3			
Rated operational voltage (Ue)	690V				690V			
Degree of pollution (IEC60529)	IP20				IP20			
Rated operational current Ie ($\theta \leq 40^\circ\text{C}$)								
AC-1 Ue max 690V A	25	25	25	32	25	25	32	40
AC-3 200/240V A	9	11	13	18	11	13	18	22
380/400V A	7	9	12	18	9	12	18	22
415V A	7	9	12	18	9	12	18	22
440V A	7	9	12	18	9	12	18	22
500V A	6	7	12	13	7	12	13	20
690V A	4	5	9	9	6	9	9	18
1000V A	-	-	-	-	-	-	-	-
Rated operational power ($\theta \leq 40^\circ\text{C}$)								
AC-3 200/240V kW	2.2	2.5	3.5	4.5	2.5	3.5	4.5	5.5
380/400V kW	3	4	5.5	7.5	4	5.5	7.5	11
415V kW	3	4	5.5	7.5	4	5.5	7.5	11
440V kW	3	4	5.5	7.5	4	7.5	7.5	15
500V kW	3	4	7.5	7.5	4	7.5	7.5	15
690V kW	3	4	7.5	7.5	-	-	-	-
1000V kW	-	-	-	-	-	-	-	-
According to IEC60947-4-1								
Rated making capacity AC-3	70	90	120	180	90	120	180	220
Rated breaking capacity AC-3	56	72	96	144	72	96	144	176
Electrical life for Ie/AC-3 Max in millions of operating cycles	2.5	2.5	2.5	2.5	2.5	2.5	2.5	2.5
Maximum operating rate in operating cycles per hour	1800	1800	1800	1800	1800	1800	1800	1800

Devices usable in the starter combination

Contactors		18AF				22AF			
		MC-6a	MC-9a	MC-12a	MC-18a	MC-9b	MC-12b	MC-18b	MC-22b
with AC or DC control coil		-	-	-	-	-	-	-	-
with coil in common use for AC and DC		-	-	-	-	-	-	-	-
Thermal Overload Relays		18AF				22AF			
Class 10A	Differential type	MT-12/3K				MT-32/3K			
	Non-differential type	MT-12/3H				MT-32/3H			
	Non-differential type(2-heater)	MT-12/2H				MT-32/2H			
Class 20	Differential type	MT-12/3D				MT-32/3D			
	Setting range A	0.1~18A				0.1~40A			



40AF	
MS-32a	MS-40a
3	
690V	
IP20	
50	60
32	40
32	40
32	40
32	40
28	32
20	23
17	17
7.5	11
15	18.5
15	18.5
15	18.5
18.5	22
18.5	22
22	22
320	400
256	320
2	2
1800	1800

65AF	
MS-50a	MS-65a
3	
690V	
IP20	
70	100
55	65
50	65
50	65
50	65
43	60
28	35
23	23
15	18.5
22	30
22	30
22	30
30	33
30	33
30	30
500	650
400	520
2	2
1800	1800

100AF		
MS-75a	MS-85a	MS-100a
3		
690V		
IP20		
110	135	160
75	85	105
75	85	105
75	85	105
75	85	105
64	75	85
42	45	65
28	28	28
22	25	30
37	45	55
37	45	55
37	45	55
37	45	55
37	45	55
37	45	55
37	37	37
750	850	1050
600	650	840
2	2	2
1800	1800	1800

MC-32a	MC-40a
-	-
MT-32/3K	
MT-32/3H	
MT-32/2H	
MT-32/3D	
0.1-40A	

MC-50a	MC-65a
-	-
MT-63/3K	
MT-63/3H	
MT-63/2H	
MT-63/3D	
4-65A	

MC-75a	MC-85a	MC-100a
-	-	-
MT-95/3K		
MT-95/3H		
MT-95/2H		
MT-95/3D		
7-100A		

Motor starters

Description

- Opened direct motor starter
- 3-pole(NO) main contacts
- Screw mountable
- AC/DC common use control contactor used (from 225AF)
- Additional accessories available
- Overload relay is directly mounted to the contactor
- Degree of protection: IP20



Rating

Starter type	150AF		225AF	
	MS-130a	MS-150a	MS-185a	MS-225a
Number of poles	3		3	
Rated operational voltage (Ue)	690V		690V	
Degree of pollution (IEC60529)	IP20		IP20	
Rated operational current Ie ($\theta \leq 40^\circ\text{C}$)				
AC-1 Ue max 690V A	160	210	230	275
AC-3 200/240V A	130	150	185	225
380/400V A	130	150	185	225
415V A	130	150	185	225
440V A	130	150	185	225
500V A	90	100	180	200
690V A	60	60	120	150
1000V A	53	65	90	90
Rated operational power ($\theta \leq 40^\circ\text{C}$)				
AC-3 200/240V kW	37	45	55	75
380/400V kW	60	75	90	132
415V kW	60	75	90	132
440V kW	60	75	90	132
500V kW	60	70	110	132
690V kW	55	55	110	140
1000V kW	75	90	132	132
According to IEC60947-4-1				
Rated making capacity AC-3	1200	1500	1850	2250
Rated breaking capacity AC-3	960	1200	1480	1800
Electrical life for Ie/AC-3 Max in millions of operating cycles	1	1	1	1
Maximum operating rate in operating cycles per hour	1200	1200	1200	1200

Devices usable in the starter combination

Contactors		150AF		225AF	
		MC-130a	MC-150a	-	-
with AC or DC control coil					
with coil in common use for AC and DC		-	-	MC-185a	MC-225a
Thermal Overload Relays		150AF		225AF	
Class 10A	Differential type	MT-150/3K		MT-225/3K	
	Non-differential type	MT-150/3H		MT-225/3H	
	Non-differential type(2-heater)	MT-150/2H		MT-225/2H	
Class 20	Differential type	MT-150/3D		MT-225/3D	
	Setting range A	34~150A		65~240A	



400AF		
MS-265a	MS-330a	MS-400a
3		
690V		
IP20		
300	350	450
265	330	400
265	330	400
265	330	400
265	330	400
225	250	350
185	220	300
105	105	105
80	90	125
147	160	200
147	160	200
147	160	200
147	160	225
160	200	250
147	147	147
2650	3300	4000
2120	2640	3200
1	1	0.5
1200	1200	1200

800AF		
MS-500a	MS-630a	MS-800a
3		
690V		
IP20		
580	660	900
500	630	800
500	630	800
500	630	800
500	630	800
400	500	720
380	420	630
220	220	220
147	190	220
265	330	440
265	330	440
265	330	440
265	330	500
300	400	500
280	280	280
5000	6300	8000
4000	5040	6400
0.5	0.5	0.5
1200	1200	1200

-	-	-
MC-265a	MC-330a	MC-400a
MT-400/3K		
MT-400/3H		
MT-400/2H		
MT-400/3D		
85-400A		

-	-	-
MC-500a	MC-630a	MC-800a
MT-800/3K		
MT-800/3H		
MT-800/2H		
MT-800/3D		
200-800A		

Reversing contactors

Description

- Two AC or DC control contactors are interlocked mechanically and electrically
- 3-pole(NO) main contact in each contactor
- Finger proof design
- DIN rail or screw mountable
- Front/side mountable accessories available
- Overload relay can be directly mounted to the contactor if necessary
- Please use interval time of over 25ms
- Degree of protection: IP20

Circuit diagram

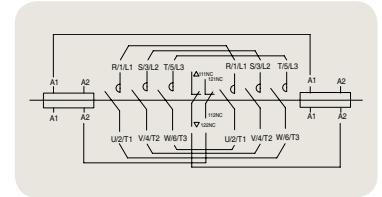

Rating

Type	AC-3 duty							Current (AC3)	Weight (AC control)
	200 ~ 240V	380 ~ 400V	415V	440V	500V	690V	1000V	440V	
	kW	kW	kW	kW	kW	kW	kW	A	
MC-6a/R	2.2	3	3	3	3	3	-	7	0.63kg
MC-9a/R	2.5	4	4	4	4	4	-	9	0.63kg
MC-12a/R	3.5	5.5	5.5	5.5	7.5	7.5	-	12	0.63kg
MC-18a/R	4.5	7.5	7.5	7.5	7.5	7.5	-	18	0.63kg
MC-9b/R	2.5	4	4	4	4	4	-	9	0.75kg
MC-12b/R	3.5	5.5	5.5	5.5	7.5	7.5	-	12	0.75kg
MC-18b/R	4.5	7.5	7.5	7.5	7.5	7.5	-	18	0.75kg
MC-22b/R	5.5	11	11	11	15	15	-	22	0.75kg
MC-32a/R	7.5	18.5	18.5	18.5	22	22	22	32	0.95kg
MC-40a/R	11	18.5	18.5	18.5	22	22	22	40	0.95kg
MC-50a/R	15	22	22	22	30	30	30	50	1.7kg
MC-65a/R	18.5	30	30	30	33	33	30	65	1.7kg
MC-75a/R	22	37	37	37	37	37	37	75	3.3kg
MC-85a/R	25	45	45	45	45	45	37	85	3.3kg
MC-100a/R	30	55	55	55	55	55	37	105	3.3kg



MC-40a/R



MC-65a/R



MC-100a/R



Coil voltage

AC	50Hz	24, 32, 42, 48, 80, 100, 110, 220, 230, 240, 380, 400, 500, 550V
	60Hz	24, 48, 100, 110, 120, 200, 208, 220, 230, 240, 277, 380, 480, 600V
DC	DC	12, 20, 24, 48, 60, 80, 100, 110, 125, 200, 220, 250V

Certification

- CE(IEC)
- UL508
- CCC

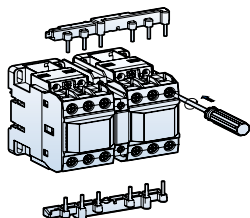

Description

- 3-pole main contact
- Mechanically interlocked
- AC/DC common use coil built (from MC-185a/R)
- Wide coil operation voltage
- Screw mountable
- 4NO4NC Auxiliary contacts built-in
- Top/side mountable accessories available
- Please use interval time of over 50ms
- Degree of protection: IP20



Rating

Type	AC-3 duty							Current (AC3)	Weight (AC control)
	200 ~ 240V	380 ~ 400V	415V	440V	500V	690V	1000V	440V	
	kW	kW	kW	kW	kW	kW	kW	A	
MC-130a/R	37	60	60	60	60	55	75	130	4.3kg
MC-150a/R	45	75	75	75	75	55	75	150	4.3kg
MC-185a/R	55	90	90	90	110	110	132	185	13kg
MC-225a/R	75	132	132	132	132	140	132	225	13kg
MC-265a/R	80	147	147	147	147	160	147	265	21.4kg
MC-330a/R	90	160	160	160	160	200	147	330	21.4kg
MC-400a/R	125	200	200	200	225	250	147	400	21.4kg
MC-500a/R	147	265	265	265	265	300	280	500	60kg
MC-630a/R	190	330	330	330	330	400	280	630	60kg
MC-800a/R	220	440	440	440	440	500	280	800	60kg



Coil voltage

For MC130a/R and MC-150a/R

AC	50/60Hz	24, 48, 100~240, 110~120, 220~240, 300, 380~440, 500V
DC	DC	24, 48, 70~110, 100~220, 110, 220V

For MC-185a/R ~ MC-800a/R

- 24, 48, 100/200, 300, 400, 500V for types MC-185a/R, 225a/R
- 100/200, 300, 400, 500V for types MC-265a/R, 330a/R, 400a/R
- 100, 200, 300, 400, 500V for types MC-500a/R, 600a/R, 800a/R

Nominal(ordering) voltage	AC 50/60Hz	DC
24V	24 - 25V	24V
48V	48 - 50V	48V
100V	100 - 127V	100 - 110V
200V	200 - 240V	200 - 220V
100/200V	100 - 240V	100 - 220V
300V	265 - 347V	-
400V	380 - 450V	-
500V	440 - 575V	-

LED voltage monitoring contactor



Description

- Real time observe coil voltage without additional equipments for protect coil burn out due to the under and over voltage

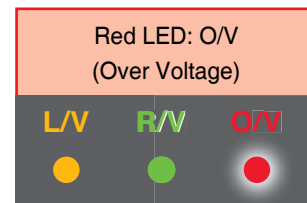
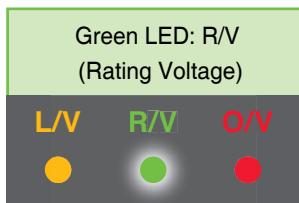
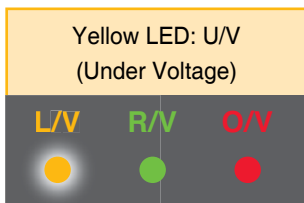

Coil voltage

Type	Coil voltage	LED indicate statue		
		Under Voltage (Yellow)	Rating Voltage (Green)	Over Voltage (Red)
MC-130a, MC 150a	110V	~80V	80~130V	130V~
	220V	~160V	160~260V	260V~
	400V	~330V	330~480V	280V~
MC-185a, MC-225a	110V	~80V	80~130V	130V~
	220V	~160V	160~260V	260V~
	400V	~330V	330~480V	280V~
MC-265a, MC-330a, MC-400a	110V	~80V	80~130V	130V~
	220V	~160V	160~260V	260V~
	400V	~330V	330~480V	280V~
MC-500a, MC-630a, MC-800a	110V	~80V	80~130V	130V~
	220V	~160V	160~260V	260V~

* The accuracy of LED indicate statue is $\pm 5\%$

Contactors relays

Description

- 4,6,8 pole units
- AC/DC control voltage
- 16A continuous current, Ith
- DIN rail or screw mountable
- Degree of protection: IP20

Selection

Poles	Composition	Types	Remarks
4 Pole	4NO 3NO1NC 2NO2NC 1NO3NC 4NC	MR-4	Additional auxiliary contacts can be mounted on the relays.
6 Pole	6NO 5NO1NC 4NO2NC 3NO3NC 2NO4NC	MR-6	UA-2 is mounted on the MR-6.
8 Pole	8NO 7NO1NC 6NO2NC 5NO3NC 4NO4NC	MR-8	UA-4 is mounted on the MR-8.



MR-4



MR-6



MR-8

Ratings

Rated insulation voltage (Ui)		AC 690V					
Continuous current (Ith)		16A					
Operating cycle		1800 operations/hour					
Endurance	Mechanical life time	10 mil. Operations					
	Electrical life time	0.25 mil. Operations					
Type		MR-4	MR-6	MR-8			
AC-15	Rated current (A)	120V	6	6	6		
		240V	3	3	3		
		380V	1.9	1.9	1.9		
		480V	1.5	1.5	1.5		
		500V	1.4	1.4	1.4		
		600V	1.2	1.2	1.2		
DC-13	Rated current (A)	125V	1.1	1.1	0.55	1.1	0.55
		250V	0.55	0.55	0.27	0.55	0.27
		400V	0.31	0.31	0.15	0.31	0.15
		500V	0.27	0.27	0.13	0.27	0.13
		600V	0.2	0.2	0.1	0.2	0.1
Minimum rated through current		DC 24V 10mA					



Coil voltage

AC	50Hz	24, 32, 42, 48, 80, 100, 110, 120, 220, 230, 240, 380, 400, 500, 550V
	60Hz	24, 48, 110, 120, 200, 208, 220, 230, 240, 277, 380, 480, 600V
DC	DC	12, 20, 24, 48, 60, 80, 100, 110, 125, 200, 220, 250V
Voltage limit		85%~110%

Note) See page 22, 23 for details.

* Please be cautious for wiring control power cable, especially "+" (Positive) and "-" (Negative) polarity should be correctly considered.

Description

- 3-pole main contact
- Mechanically latched
- Finger proof design
- DIN rail or screw mountable
- Side mountable accessories available
- Direct mountable overload relays available



Circuit diagram

MC-6a/L~150a/L

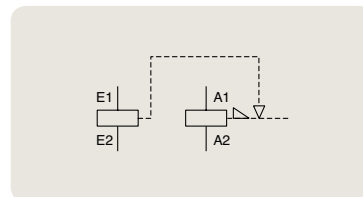

Rating

Contactor	AC3 ratings					Devices combined			
	200/240V kW	380/440V kW	500/550V kW	690V kW	1000V kW	Type	Durability (Mechanical)	Operational time	Excitation time
MC-6a/L	2.2	3	3	3	-	ML-65	0.5 mil.	Less 30ms (AC)	More than 50ms (AC)
MC-9a/L	2.5	4	4	4	-				
MC-12a/L	3.5	5.5	7.5	7.5	-				
MC-18a/L	4.5	7.5	7.5	7.5	-				
MC-9b/L	2.5	4	4	4	-				
MC-12b/L	3.5	5.5	7.5	7.5	-				
MC-18b/L	4.5	7.5	7.5	7.5	-				
MC-22b/L	5.5	11	15	15	-				
MC-32a/L	11	18.5	22	22	22				
MC-40a/L	11	18.5	22	22	22				
MC-50a/L	15	22	30	30	30	ML-150	2.5 mil.	Less 50ms (DC)	More than 70ms (DC)
MC-65a/L	18.5	30	33	33	30				
MC-75a/L	22	37	37	37	37				
MC-85a/L	25	45	45	45	37				
MC-100a/L	30	55	55	45	37				
MC-130a/L	37	60	60	55	75				
MC-150a/L	45	75	75	55	75	Less 100ms	More than 130ms		



Coil voltage

AC	50/60Hz	24, 48, 100, 110, 120, 200, 220, 230, 240, 380, 400, 415, 440V
DC	DC	24, 48, 110V

Certification

- CE(IEC)
- UL508

Accessories

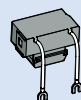

Surge unit, US
connecting to coil
terminals
► 84 page

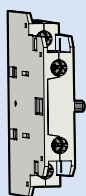

Auxiliary contact unit, UA-1
side mount, 1NO+1NC
► 77 page

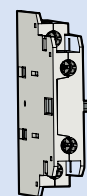

Auxiliary contact unit, UA-1
side mount, 1NO+1NC
► 77 page

* It is not possible to attach "UA-1"
on the right side of product for
Range MC-9b~22b.



Overload relay
MT-12 - MT-150
► 90 page

Description

- 3-pole main contact
- Mechanically interlocked
- AC/DC common use coil built
- Wide coil operation voltage
- Screw mountable
- 1NO+2NC Auxiliary contacts built-in as standard
- Top/side mountable accessories available



Circuit diagram

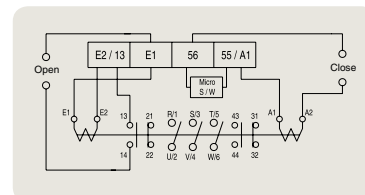

Rating

Contactor	AC3 ratings					Auxiliary contact (standard)
	200 ~ 240V	380 ~ 440V	500 ~ 550V	690V	1000V	
MC-185a/L	55kW 185A	90kW 185A	110kW 180A	110kW 120A	132kW 90A	2NO2NC
MC-225a/L	75kW 225A	132kW 225A	132kW 200A	140kW 150A	132kW 90A	
MC-265a/L	80kW 265A	147kW 265A	147kW 225A	160kW 185A	147kW 105A	
MC-330a/L	90kW 330A	160kW 330A	160kW 280A	200kW 225A	147kW 105A	
MC-400a/L	125kW 400A	200kW 400A	225kW 350A	250kW 300A	147kW 105A	



Coil voltage

Nominal(ordering) voltage	Operational voltage	Operation frequency
100V	AC100-127V	600 operations/hour
	DC100-125V	300 operations/hour
200V	AC200-240V	600 operations/hour
	DC200-220V	300 operations/hour

Accessories



AP220~400
Terminal cover
▶ 81 page



AU-100, 100E
Auxiliary contact unit
side mount, 1NO+1NC
▶ 78 page



AI-180
Insulation barrier
▶ 81 page



Overload relay
MT-225H ~ MT-400H
MT-225/3H ~ MT-400/3H
MT-225/3K ~ MT-400/3K
▶ 93 page

4-pole Contactors (18AF)

Description

- 4-pole main contact
- Finger proof design
- DIN rail or screw mountable
- Small physical size: 44 mm wide
- Auxiliary contacts are optional
- Front/side mountable accessories
- Direct mountable overload relays available
- Degree of protection: IP20

Rating



MC-18a/4

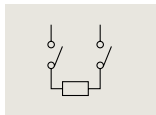

2pole for DC contact

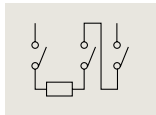

3pole for DC contact

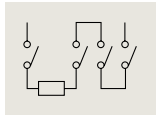

4pole for DC contact

Contactor type			MC-6a/4		MC-9a/4		MC-12a/4		MC-18a/4		
			kW	A	kW	A	kW	A	kW	A	
AC duty	AC1	200/240V	9	25	9	25	9	25	15	40	
		380/440V	17	25	17	25	17	25	27	40	
		500/550V	21	25	21	25	21	25	35	40	
		690V	27	25	27	25	27	25	44	40	
	AC3	200/240V	2.2	9	2.5	11	3.5	13	4.5	18	
		380/440V	3	7	4	9	5.5	12	7.5	18	
lth		-	25	-	25	-	25	-	40		
DC1 duty (L/R=1ms)	2-pole	110V	-	12	-	12	-	12	-	12	
	in series	220V	-	8	-	8	-	8	-	8	
	3-pole	110V	-	15	-	15	-	15	-	15	
	in series	220V	-	10	-	10	-	10	-	10	
	4-pole	110V	-	17	-	17	-	17	-	17	
	in series	220V	-	12	-	12	-	12	-	12	
UL rating			hp	A	hp	A	hp	A	hp	A	
			220/240V	3	-	3	-	5	-	7.5	-
			440/480V	5	-	5	-	7.5	-	10	-
			550/600V	7.5	-	7.5	-	10	-	15	-
			lth	-	25	-	25	-	25	-	32
Conductor size (solid, stranded)		AWG	18~10		18~10		16~10		16~8		
(the max. number of conduct: 2)		mm ²	1.5~4		1.5~10		1.5~10		1~4		
Conductor type			65/75°C Cu-wire only								



Coil voltage

AC	50Hz	24, 32, 42, 48, 80, 100, 110, 220, 230, 240, 380, 400, 500, 550V
	60Hz	24, 48, 100, 110, 120, 200, 208, 220, 230, 240, 277, 380, 480, 600V
	50/60Hz	24, 48, 100, 110, 120, 200, 220, 230, 240, 380, 415, 440, 500, 550V
DC	DC	12, 20, 24, 48, 60, 80, 100, 110, 125, 200, 220, 250V

Certification

- CE(IEC)
- UL508
- CCC

Accessories



Delayed opening device, AD-9
▶ 81 page



Surge unit, US
connecting to coil terminals
▶ 84 page

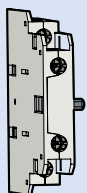

Auxiliary contact unit, UA-1
side mount, 1NO+1NC
▶ 77 page

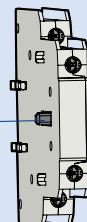

Interlock unit, UR
side mount
▶ 82 page

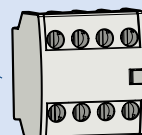

Auxiliary contact unit, UA-4
front mount, 4P
▶ 77 page



Auxiliary contact unit, UA-2
front mount, 2P
▶ 77 page



Safety cover, A7
▶ 87 page

4-pole Contactors (22, 40AF)

Description

- 4-pole main contact
- Finger proof design
- DIN rail or screw mountable
- Auxiliary contacts are optional
- Front/side mountable accessories
- Direct mountable overload relays available
- Degree of protection: IP20

Rating

Contactor type			MC-22a/4		MC-32a/4		MC-40a/4	
			kW	A	kW	A	kW	A
AC duty	AC1	200/240V	15	40	18	50	22	60
		380/440V	27	40	35	50	42	60
		500/550V	35	40	43	50	52	60
		690V	44	40	55	50	66	60
	AC3	200/240V	5.5	22	7.5	32	11	40
		380/440V	11	22	15	32	18.5	40
lth		-	40	-	50	-	60	
DC1 duty (L/R=1ms)	2-pole	110V	-	15	-	25	-	25
		in series 220V	-	10	-	12	-	12
	3-pole	110V	-	20	-	27	-	27
		in series 220V	-	12	-	15	-	15
	4-pole	110V	-	20	-	30	-	30
		in series 220V	-	15	-	22	-	22
UL rating			hp	A	hp	A	hp	A
		220/240V	7.5	-	10	-	10	-
		440/480V	10	-	20	-	25	-
		550/600V	15	-	20	-	25	-
		lth	-	32	-	45	-	50
Conductor size (solid, stranded)		AWG	12~8		10~6		8~6	
(the max. number of conductors: 2)		mm ²	2.5~10		4~16		10~16	
Conductor type			65/75°C Cu-wire only					



MC-22a/4



MC-40a/4

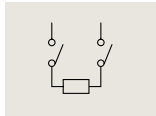

2pole for DC contact

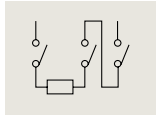

3pole for DC contact

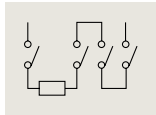

4pole for DC contact

Coil voltage

AC	50Hz	24, 32, 42, 48, 80, 100, 110, 220, 230, 240, 380, 400, 500, 550V
	60Hz	24, 48, 100, 110, 120, 200, 208, 220, 230, 240, 277, 380, 480, 600V
	50/60Hz	24, 48, 100, 110, 120, 200, 220, 230, 240, 380, 415, 440, 500, 550V
DC	DC	12, 20, 24, 48, 60, 80, 100, 110, 125, 200, 220, 250V

Certification

- CE(IEC)
- UL508
- CCC

Accessories

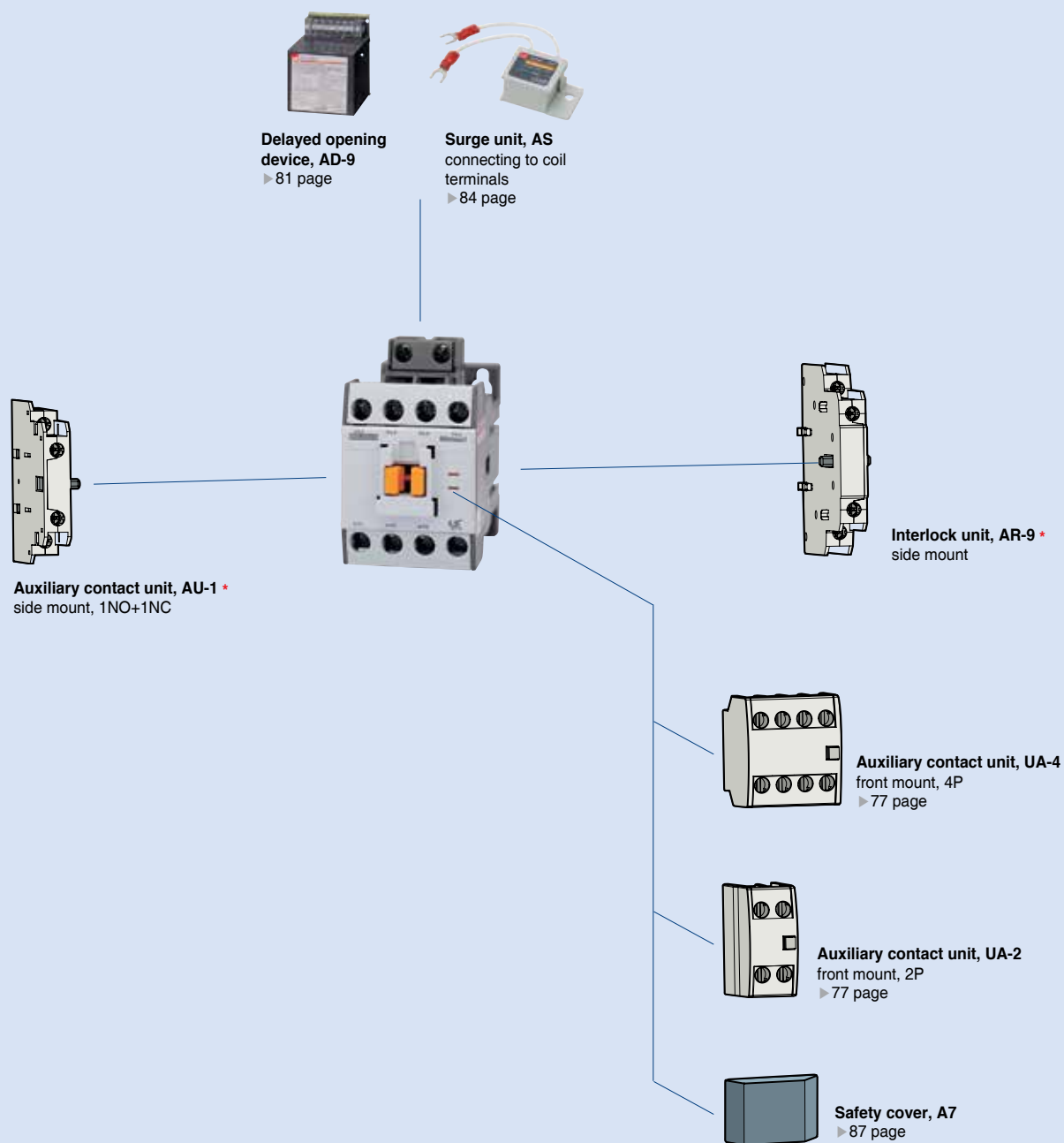

* AU-1 and AR-9 are discontinued item. Please contact us in case of purchasing.

4-pole Contactors (85AF)

Description

- 4-pole main contact
- Finger proof design
- DIN rail or screw mountable
- Auxiliary contacts are optional
- Front/side mountable accessories
- Direct mountable overload relays available
- Degree of protection: IP20

Rating



MC-85a/4

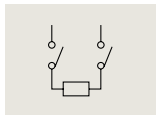

2pole for DC contact

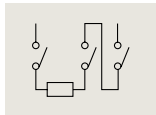

3pole for DC contact

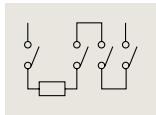

4pole for DC contact

Contactor type			MC-50a/4		MC-65a/4		MC-75a/4		MC-85a/4		
			kW	A	kW	A	kW	A	kW	A	
AC duty	AC1	200/240V	30	80	37	100	41	110	51	135	
		380/440V	56	80	70	100	76	110	95	135	
		500/550V	70	80	88	100	97	110	120	135	
		690V	88	80	110	100	120	110	150	135	
	AC3	200/240V	15	55	18.5	65	22	75	25	85	
		380/440V	22	50	30	65	37	75	45	85	
lth		-	80	-	100	-	110	-	135		
DC1 duty (L/R=1ms)	2-pole	110V	-	35	-	35	-	50	-	50	
		in series 220V	-	15	-	15	-	35	-	35	
	3-pole	110V	-	40	-	40	-	60	-	60	
		in series 220V	-	30	-	30	-	40	-	40	
	4-pole	110V	-	50	-	50	-	70	-	70	
		in series 220V	-	35	-	35	-	50	-	50	
UL rating			hp	A	hp	A	hp	A	hp	A	
			220/240V	15	-	20	-	25	-	30	-
			440/480V	30	-	40	-	50	-	50	-
			550/600V	30	-	40	-	50	-	50	-
			lth	-	70	-	80	-	90	-	100
Conductor size (solid, stranded)			AWG	8~4		6~3		4~2		4~1	
(the max. number of conducts: 2)			mm ²	10~25		16~35		25~35		25~50	
Conductor type			65/75°C Cu-wire only								

Coil voltage

AC	50Hz	24, 32, 42, 48, 80, 100, 110, 220, 230, 240, 380, 400, 500, 550V
	60Hz	24, 48, 100, 110, 120, 200, 208, 220, 230, 240, 277, 380, 480, 600V
	50/60Hz	24, 48, 100, 110, 120, 200, 220, 230, 240, 380, 415, 440, 500, 550V
DC	DC	12, 20, 24, 48, 60, 80, 100, 110, 125, 200, 220, 250V

Certification

- CE(IEC)
- UL508
- CCC

Accessories

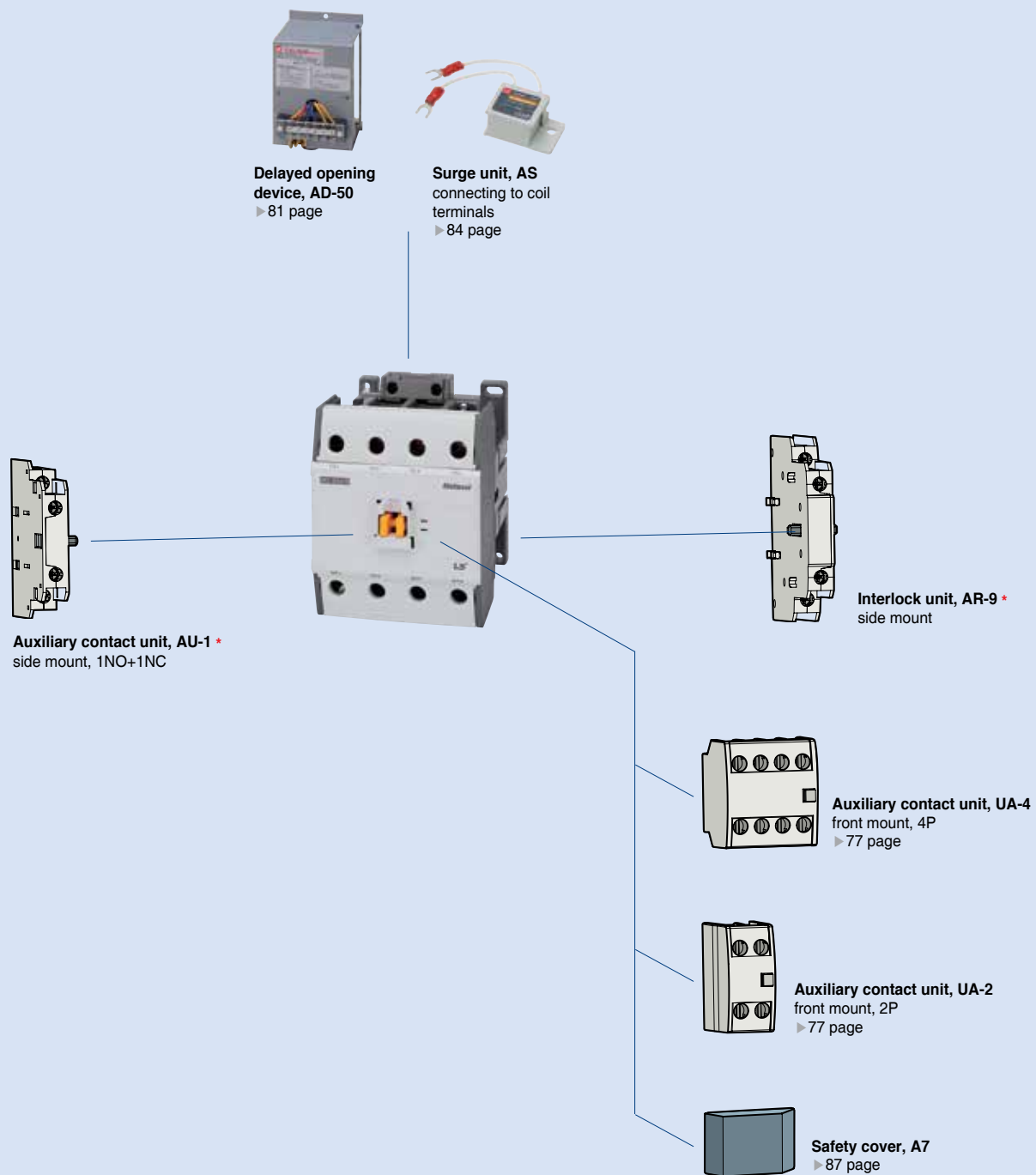

* AU-1 and AR-9 are discontinued item. Please contact us in case of purchasing.

4-pole Contactors (225AF)

Description

- 4-pole main contact
- AC/DC common use coil built
- Wide coil operation voltage
- Screw mountable
- 2NO+2NC Auxiliary contacts built-in as standard
- Side mountable accessories
- Direct mountable overload relays available
- Degree of protection: IP20

Rating

Contactor type			MC-100a/4		MC-130a/4		MC-150a/4		MC-185a/4		MC-225a/4		
			kW	A	kW	A	kW	A	kW	A	kW	A	
AC duty	AC1	200/240V	57	150	60	155	76	200	87	230	100	260	
		380/440V	106	150	110	155	142	200	165	230	185	260	
		500/550V	132	150	137	155	180	200	205	230	230	260	
		690V	165	150	170	155	225	200	255	230	290	260	
	AC3	200/240V	30	105	37	125	45	150	55	185	75	225	
		380/440V	55	105	60	120	75	150	90	185	132	225	
		lth	-	160	-	165	-	250	-	300	-	330	
		DC1 duty	2-pole	110V	-	80	-	80	-	100	-	150	-
(L/R=1ms)	in series	220V	-	50	-	50	-	100	-	150	-	150	
	3-pole	110V	-	90	-	90	-	150	-	185	-	225	
		in series	220V	-	60	-	60	-	150	-	185	-	225
	4-pole	110V	-	100	-	100	-	150	-	185	-	225	
		in series	220V	-	80	-	80	-	150	-	185	-	225
UL rating			hp	A	hp	A	hp	A	hp	A	hp	A	
			220/240V	30	-	40	-	50	-	60	-	75	-
			440/480V	60	-	75	-	100	-	125	-	150	-
			550/600V	60	-	75	-	100	-	125	-	150	-
			lth	-	160	-	160	-	210	-	230	-	275
Conductor size (solid, stranded)		AWG	6-00		3-00		3-4/0		1-4/0		0-300		
(the max. number of conductors: 2)		mm ²	16-70		35-70		35-95		50-95		50-150		
Conductor type			75°C Cu stranded wire										



MC-225a/4

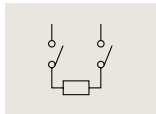

2pole for DC contact

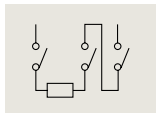

3pole for DC contact

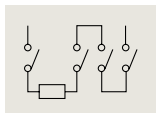

4-pole in series

Coil voltage, AC/DC common

Nominal(ordering) voltage	AC 50/60Hz	DC
24V	24 - 25V	24V
48V	48 - 50V	48V
100/200V	100 - 240V	100 - 220V
300V	265 - 347V	-
400V	380 - 450V	-
500V	440 - 575V	-

Certification

- CE(IEC)
- UL508
- CCC

Accessories



AD-100
Delayed opening device
▶ 81 page



Safety cover, A7
▶ 87 page



AP220/4
Terminal cover
▶ 81 page



AI-180
Insulation barrier
▶ 81 page



AU-100, 100E
Auxiliary contact unit
side mount, 1NO+1NC
▶ 78 page



AR-180
Interlock unit
side mount
▶ 83 page

4-pole Contactors (400AF)

Description

- 4-pole main contact
- AC/DC common use coil built
- Wide coil operation voltage
- Screw mountable
- 2NO+2NC Auxiliary contacts built-in as standard
- Side mountable accessories
- Degree of protection: IP20

Rating



MC-400a/4

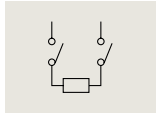

2pole for DC contact

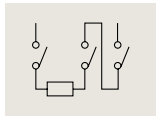

3pole for DC contact

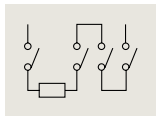

4pole for DC contact

Contactor type			MC-265a/4		MC-330a/4		MC-400a/4		
			kW	A	kW	A	kW	A	
AC duty	AC1	200/240V	115	300	135	350	160	420	
		380/440V	215	300	250	350	300	420	
		500/550V	265	300	315	350	375	420	
		690V	335	300	390	350	470	420	
	AC3	200/240V	80	265	90	330	125	400	
		380/440V	147	265	160	330	200	400	
lth		-	360	-	420	-	500		
DC1 duty (L/R=1ms)	2-pole	110V	-	200	-	200	-	200	
	in series	220V	-	200	-	200	-	200	
	3-pole	110V	-	265	-	330	-	400	
	in series	220V	-	265	-	330	-	400	
	4-pole	110V	-	265	-	330	-	400	
	in series	220V	-	265	-	330	-	400	
UL rating			hp	A	hp	A	hp	A	
			220/240V	100	-	125	-	150	-
			440/480V	200	-	250	-	300	-
			550/600V	200	-	250	-	300	-
			lth	-	300	-	350	-	450
Conductor size (solid, stranded)		AWG	3/0-500		4/0-500		350-700		
(the max. number of conductors: 2)		mm ²	95-240		95-240		185-370		
Conductor type			75°C Cu stranded wire						

Coil voltage, AC/DC common

Nominal(ordering) voltage	AC 50/60Hz	DC
100/200V	100 - 240V	100 - 220V
300V	265 - 347V	-
400V	380 - 450V	-
500V	440 - 575V	-

Certification

- CE(IEC)
- UL508
- CCC

Accessories



AD-300
Delayed opening device
▶ 81 page



Safety cover, A7
▶ 87 page



AP-400/4
Terminal cover
▶ 81 page



AI-180
Insulation barrier
▶ 81 page



AU-100, 100E
Auxiliary contact unit
side mount, 1NO+1NC
▶ 78 page



AR-180
Interlock unit
side mount
▶ 83 page

4-pole Contactors (800AF)

Description

- 4-pole main contact
- AC/DC common use coil built
- Wide coil operation voltage
- Screw mountable
- 2NO+2NC Auxiliary contacts built-in as standard
- Side mountable accessories
- Degree of protection: IP20

Rating



MC-800a/4

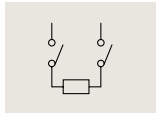

2pole for DC contact

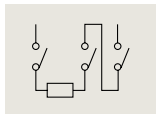

3pole for DC contact

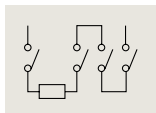

4pole for DC contact

Contactor type			MC-500a/4		MC-630a/4		MC-800a/4		
			kW	A	kW	A	kW	A	
AC duty	AC1	200/240V	245	630	255	660	310	800	
		380/440V	450	630	470	660	570	800	
		500/550V	560	630	590	660	710	800	
		690V	710	630	740	660	900	800	
	AC3	200/240V	147	500	190	630	220	800	
		380/440V	265	500	330	630	440	800	
lth		-	630	-	750	-	900		
DC1 duty (L/R=1ms)	2-pole	110V	-	500	-	630	-	630	
		220V	-	500	-	630	-	630	
	3-pole	110V	-	500	-	630	-	800	
		220V	-	500	-	630	-	800	
	4-pole	110V	-	500	-	630	-	800	
		220V	-	500	-	630	-	800	
UL rating			hp	A	hp	A	hp	A	
			220/240V	200	-	250	-	300	-
			440/480V	400	-	500	-	600	-
			550/600V	400	-	500	-	600	-
			lth	-	580	-	660	-	900
Conductor size (solid, stranded)		AWG	350~800		600~2000		1700~Busbar		
(the max. number of conductors: 2)		mm ²	185~480		-		-		
Conductor type			75°C Cu stranded wire						

Coil voltage, AC/DC common

Nominal(ordering) voltage	AC 50/60Hz	DC
100V	100 - 127V	100 - 110V
200V	200 - 240V	200 - 220V
300V	265 - 347V	-
400V	380 - 450V	-
500V	440 - 575V	-

Certification

- CE(IEC)
- UL508
- CCC

Accessories



AD-600
Delayed opening device
▶ 81 page

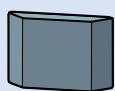

Safety cover, A7
▶ 87 page



AP-800/4
Terminal cover
▶ 81 page



AI-600
Insulation barrier
▶ 81 page



AU-100, 100E
Auxiliary contact unit
side mount, 1NO+1NC
▶ 78 page



AR-600
Interlock unit
▶ 83 page

Enclosed motor starters, Mold enclosure

Description



- Enclosed & full voltage type
- MW-□bM: Plastic enclosure without buttons
- MW-□bMB: Plastic enclosure with ON/OFF buttons
- With differential or non-differential type thermal overload relay
- Contactors: 3 pole with AC coil
- Screw mountable
- Degree of protection: IP40

Ratings



Type	AC3 Ratings				Continuous current lth	Auxiliary contact (standard)	Devices combined	
	220 ~ 240V	380 ~ 440V	500 ~ 550V	690			Contactor	Overload relay
MW-9bM(B)	2.5kW 11A	4kW 9A	4kW 7A	4kW 6A	25A	1NO1NC	MC-9b	MT-32 (0.1~22A)
MW-12bM(B)	3.5kW 13A	5.5kW 12A	7.5kW 12A	7.5kW 9A	25A		MC-12b	
MW-18bM(B)	4.5kW 18A	7.5kW 18A	7.5kW 13A	7.5kW 9A	40A		MC-18b	
MW-22bM(B)	5.5kW 22A	11kW 22A	15kW 20A	15kW 18A	40A		MC-22b	

Overload relay setting range, Amp.

MT-12		MT-32		MT-63		MT-95	
0.1 - 0.16	5 - 8	0.1 - 0.16	5 - 8	4 - 6	28 - 40	7 - 10	54 - 75
0.16 - 0.25	6 - 9	0.16 - 0.25	6 - 9	5 - 8	34 - 50	9 - 13	63 - 85
0.25 - 0.4	7 - 10	0.25 - 0.4	7 - 10	6 - 9	45 - 65	12 - 18	70 - 95
0.4 - 0.63	9 - 13	0.4 - 0.63	9 - 13	7 - 10		16 - 22	80 - 100
0.63 - 1	12 - 18	0.63 - 1	12 - 18	9 - 13		18 - 25	
1 - 1.6		1 - 1.6	16 - 22	12 - 18		24 - 36	
1.6 - 2.5		1.6 - 2.5	18 - 25	16 - 22		28 - 40	
2.5 - 4		2.5 - 4	22 - 32	18 - 25		34 - 50	
4 - 6		4 - 6	28 - 40	24 - 36		45 - 65	



Internal device



Coil voltage

AC	50Hz	24, 32, 42, 48, 80, 100, 110, 220, 230, 240, 380, 400, 500, 550V
	60Hz	24, 48, 100, 110, 120, 200, 208, 220, 230, 240, 277, 380, 480, 600V
DC	DC	12, 20, 24, 48, 60, 80, 100, 110, 125, 200, 220, 250V

Certification

- CE(IEC)
- UL508

Enclosed motor starters, Steel enclosure

Description



- Full voltage type
- MW-□a/MW-□b: Steel enclosure without buttons
- MW-□aB/MW-□bB: Steel enclosure ON/OFF buttons
- Contactors: 3 pole with AC coil
- Overload relay With differential or non-differential type
- Screw mountable
- Degree of protection: IP40

Ratings



Type	AC3 Ratings					Devices combined	
	220 ~ 240V	380 ~ 440V	500 ~ 550V	690V	1000V	Contactor relay	Overload
MW-6a(B)	2.2kW 9A	3kW 7A	3kW 6A	3kW 4A	-	MC-6a	MT-12 (0.1~18A)
MW-9a(B)	2.5kW 11A	4kW 9A	4kW 7A	4kW 5A	-	MC-9a	
MW-12a(B)	3.5kW 13A	5.5kW 12A	7.5kW 12A	7.5kW 9A	-	MC-12a	
MW-18a(B)	4.5kW 18A	7.5kW 18A	7.5kW 13A	7.5kW 9A	-	MC-18a	
MW-9b(B)	2.5kW 11A	4kW 9A	4kW 7A	4kW 6A	-	MC-9b	MT-32 (0.1~22A)
MW-12b(B)	3.5kW 13A	5.5kW 12A	7.5kW 12A	7.5kW 9A	-	MC-12b	
MW-18b(B)	4.5kW 18A	7.5kW 18A	7.5kW 13A	7.5kW 9A	-	MC-18b	
MW-22b(B)	5.5kW 22A	11kW 22A	15kW 20A	15kW 18A	-	MC-22b	
MW-32a(B)	7.5kW 32A	15kW 32A	18.5kW 28A	18.5kW 20A	22kW 17A	MC-32a	MT-32
MW-40a(B)	11kW 40A	18.5kW 40A	22kW 32A	22kW 23A	22kW 17A	MC-40a	(0.1~40A)
MW-50a(B)	15kW 55A	22kW 50A	30kW 43A	30kW 28A	30kW 23A	MC-50a	MT-63
MW-65a(B)	18.5kW 65A	30kW 65A	33kW 60A	33kW 35A	33kW 26A	MC-65a	(4~65A)
MW-75a(B)	22kW 75A	37kW 75A	37kW 64A	37kW 42A	37kW 28A	MC-75a	MT-95 (7~100A)
MW-85a(B)	25kW 85A	45kW 85A	45kW 75A	45kW 45A	45kW 33A	MC-85a	
MW-100a(B)	30kW 105A	55kW 105A	55kW 85A	55kW 65A	45kW 33A	MC-100a	



Internal device

Overload relay setting range, Amp.

MT-12		MT-32		MT-63		MT-95	
0.1 - 0.16	5 - 8	0.1 - 0.16	5 - 8	4 - 6	28 - 40	7 - 10	54 - 75
0.16 - 0.25	6 - 9	0.16 - 0.25	6 - 9	5 - 8	34 - 50	9 - 13	63 - 85
0.25 - 0.4	7 - 10	0.25 - 0.4	7 - 10	6 - 9	45 - 65	12 - 18	70 - 95
0.4 - 0.63	9 - 13	0.4 - 0.63	9 - 13	7 - 10		16 - 22	80 - 100
0.63 - 1	12 - 18	0.63 - 1	12 - 18	9 - 13		18 - 25	
1 - 1.6		1 - 1.6	16 - 22	12 - 18		24 - 36	
1.6 - 2.5		1.6 - 2.5	18 - 25	16 - 22		28 - 40	
2.5 - 4		2.5 - 4	22 - 32	18 - 25		34 - 50	
4 - 6		4 - 6	28 - 40	24 - 36		45 - 65	



Coil voltage

AC	50Hz	24, 32, 42, 48, 80, 100, 110, 220, 230, 240, 380, 400, 500, 550V
	60Hz	24, 48, 100, 110, 120, 200, 208, 220, 230, 240, 277, 380, 480, 600V
DC	DC	12, 20, 24, 48, 60, 80, 100, 110, 125, 200, 220, 250V

Certification

- CE(IEC)
- UL508

Capacitor contactors

Description

Capacitor unit(Pre-loading resistor) is connected to the terminals of the contactor to reduce the high inrush current exceeding $20 \times I_n$.

- AC or DC control coil on selection
- 3-pole(NO) main contact
- Finger proof design
- DIN rail or screw mountable
- IEC 60947-4-1 AC 6b



Type	Rating (kVar, A)		
	220 ~ 240V	400 ~ 440V	500 ~ 550V
MC-9b with AC-9	5kVar	9.7kVar	14kVar
	13A	14A	16A
MC-12b with AC-9	6.7kVar	12.5kVar	18kVar
	18A	18A	21A
MC-18b with AC-9	8.5kVar	16.7kVar	24kVar
	22A	24A	28A
MC-22b with AC-9	10kVar	18kVar	26kVar
	26A	26A	30A
MC-32a with AC-9	15kVar	25kVar	36kVar
	39A	36A	42A
MC-40a with AC-9	20kVar	33.3kVar	48kVar
	52A	48A	55A
MC-50a with AC-50	20kVar	40kVar	58kVar
	52A	58A	67A
MC-65a with AC-50	25kVar	45.7kVar	66kVar
	66A	66A	76A
MC-75a with AC-75	29.7kVar	54kVar	78kVar
	78A	78A	90A
MC-85a with AC-75	35kVar	60kVar	92kVar
	92A	87A	106A
MC-100a with AC-75	37kVar	62kVar	94kVar
	97A	89A	109A

- Note** 1. When the switch is closed condenser must be discharged before recharged. (Maximum residual voltage at terminals $\leq 50V$)
 2. To prevent short current, gG type fuse must be 1.5~2 times than rated current.



Coil voltage

AC	50Hz	24, 32, 42, 48, 80, 100, 110, 220, 230, 240, 380, 400, 500, 550V
	60Hz	24, 48, 100, 110, 120, 200, 208, 220, 230, 240, 277, 380, 480, 600V
DC	DC	12, 20, 24, 48, 60, 80, 100, 110, 125, 200, 220, 250V

These capacitive contactors are suitable for switching single-step or multiple-step condenser bank.

It is standardized by IEC-60947-4941, UL and CSA.

Features of capacitor unit(Pre-loading resistor)

- Damping resistor that can limit the inrush current upto $60 \times I_n$ is connected to the mechanism that closed earlier than the main contact of the contactor
- No heat loss by the serial resistor
- Eliminate the switching surge
- Improving the performance of the capacitor system

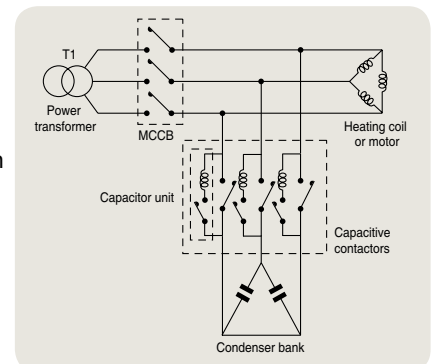

Example

2-pole AC Contactors, Definite purpose



Description

- Two normally open main contacts
- Screw clamp or fast-on connections
- Small and light design suitable for use in air conditioners, heaters, refrigerators, etc.
- Screw mountable
- No auxiliary contact
- AC control voltage



Ratings

Type	AC3 ratings			Ith	Contact	
	220~240V	380~440V	500~550V		NO	NC
GMC-10P2	10A	8A	6A	20A	2	-
GMC-20P2	20A	17A	14A	30A	2	-
GMC-25P2	25A	21A	17A	35A	2	-
GMC-30P2	30A	23A	21A	40A	2	-
GMC-35P2	35A	26A	23A	45A	2	-
GMC-40P2	40A	32A	26A	50A	2	-

Insulation voltage: 690V at AC, 250V at DC

Main terminal

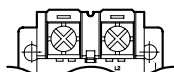

Screw clamp

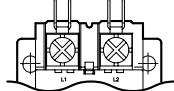

Fast-on (Quick connect)

Coil terminal

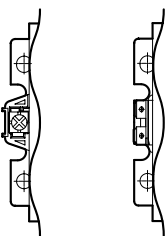

Screw clamp

Fast-on (Quick connect)

Control coil characteristics

Coil voltage	Coil consumption (VA)		Thermal dissipation (W)	Operational voltage(V)		Coil current (mA)	Operational time (ms)	
	Inrush	Holding		Pick-up	Drop-out		Closing	Opening
24V 50/60Hz	35	6.0	2	18~20	10~15	263	40	30
48V 50/60Hz	35	6.0	2	36~40	19~27	131	40	30
100V 50/60Hz	35	6.0	2	74~81	39~57	63	40	30
110V 50/60Hz	35	6.0	2	78~90	50~64	57	40	30
120V 50/60Hz	35	6.0	2	90~100	52~66	53	40	30
200V 50/60Hz	35	6.0	2	155~165	80~115	32	40	30
220V 50/60Hz	35	6.0	2	160~175	90~120	29	40	30
230V 50/60Hz	35	6.0	2	165~180	110~130	27	40	30
240V 50/60Hz	35	6.0	2	168~185	110~135	26	40	30

Note) 1. The condition of the above data: 60Hz, 20 °C from cold state
 2. Coil consumption (VA) is average value.

Type numbering system

GMC10P2		/	20	/	00	/	F7	/	AC	/	S
Product (6A~2100A)			Main contactor		Auxiliary contact		Coil voltage		Coil consumption		Terminal
GMC10P2	GMC-10P2		20 2NO0NC		00 None		Coil code Table		AC AC		S Screw Q Quick Connect
GMC20P2	GMC-20P2										
GMC25P2	GMC-25PS										
GMC30P2	GMC-30P2										
GMC35P2	GMC-35P2										
GMC40P2	GMC-40P2										
ex)			GMC10P2-20-00-F7-AC-S-E		GMC-10P2 AC110V 50/60Hz EXP						
			GMC40P2-20-00-B7-AC-Q-E		GMC-40P2 TQBQ AC24V 50/60Hz EXP						

3-pole AC Contactors, Definite purpose



Description

- Three main contacts
- Screw clamp connections
- Small and light design suitable for use in air conditioners, heaters, refrigerators, etc.
- Screw mountable
- No auxiliary contact
- AC control voltage

Ratings

Type	AC3 ratings			AC4 ratings			Ith	Contact	
	220~ 240V	380~ 440V	500~ 550V	220~ 240V	380~ 440V	500~ 550V		NO	NC
GMC-20D2 GMC-20D3	20A	17A	14A	18A	13A	10A	30A	2 3	- - 1
GMC-25D2 GMC-25D3	25A	21A	17A	20A	14A	12A	35A	2 3 2	- - 1

Note) Above contact ratings are for NO contact.
 Rating for NC contact: 6A@120V, 3A@240V, 1.5A@480V at AC15 duty
 Rating above 24V 1A
 Please use NC contact for Insulation voltage: 690V at AC, 250V at DC

Control coil characteristics

Coil voltage	Coil consumption (VA)		Thermal dissipation (W)	Operational voltage(V)		Coil current (mA)	Operational time (ms)	
	Inrush	Holding		Pick-up	Drop-out		Closing	Opening
24V 60Hz	72	9.0	3	17~19	12.5~15.5	215	30	20
48V 60Hz	72	9.0	3	32~36	26~30	125	30	20
110V 60Hz	72	9.0	3	75~85	65~75	60	30	20
220V 60Hz	72	9.0	3	150~170	120~145	41	30	20

Note) 1. The condition of the above data: 60Hz, 20 °C from cold state
 2. Coil consumption (VA) is average value.

Type numbering system

GMC20D2		/	20	/	00	/	F7	/	AC	/	S
Product (6A~2100A)			Main contactor		Auxiliary contact		Coil voltage		Coil consumption		Terminal
GMC20D2	GMC-10D2		20	2NO0NC	00	None	Coil code Table	AC	AC		S
GMC20D3	GMC-20D3		30	2NO1NC							
GMC25D2	GMC-25D2		21	3NO0NC							
GMC25P3	GMC-25D3										

Single-pole AC Contactors, Definite purpose



Description

- Single-pole NO main contact
- Small and light design suitable for use in electric shock protector for AC arc welder
- DIN rail or screw mountable
- No auxiliary contact (Optional unit can be added up to 2NO2NC)
- AC control voltage

Ratings

Type	Rated current, In 110/220V	Ith	Performance	
			Making current	Breaking current
MC-65aSP	220A	500A	1.5×In	

Control coil characteristics

Coil consumption (VA)		Operational voltage		Operational time
Inrush	Holding	Pick-up	Drop-out	Closing
150VA	17VA	85% under	20% over	30ms under

Note) Coil voltage is available between AC24V and AC50V

2-pole DC Contactors



Description

- Two normally open main contacts for DC circuit
- Positive and negative poles indicated on the front plate
- Eternal magnet installed for the effective arc extinguishing
- DIN rail or screw mountable
- 2NO+2NC Auxiliary contacts built-in as standard
- AC/DC control voltage



Selection

Contactor types	DC-2~5 ratings			Continuous current, Ith	Auxiliary contacts
	125V	250V	500V		
MD-30a	3.7kW 40A	5.5kW 30A	7.5kW 20A	60A	2a(NO)+2b(NC)
MD-60a	7.5kW 80A	11kW 60A	15kW 40A	100A	2a(NO)+2b(NC)
MD-100a	11kW 120A	18.5kW 100A	22kW 60A	135A	2a(NO)+2b(NC)

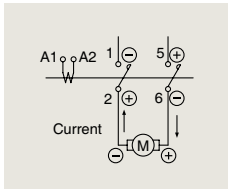

Ratings of auxiliary contacts

UA-1	AC15 duty						DC13 duty				
	120V	240V	380V	480V	500V	600V	125V	250V	400V	500V	600V
Rated currents	6A	3A	1.9A	1.5A	1.4A	1.2A	1.1A	0.55A	0.31A	0.27A	0.2A
Continuous current, Ith	16A										



Coil voltage

AC	50/60Hz	24, 48, 100, 110, 120, 200, 220, 230, 240, 380, 400, 415, 440, 500, 550V
DC	DC	12, 20, 24, 48, 60, 80, 100, 110, 125, 200, 220, 250V

Auxiliary contact units

- 2 and 4 pole
- Side and front mountable
- Common use for Metasol contactors from MC-6a to MC-150a
- Auxiliary contact meet the requirements for mirror contacts in IEC 60947-4-1. Annex F (A mirror contact is an auxiliary NC contact that cannot be closed simultaneously with a NO main contact)

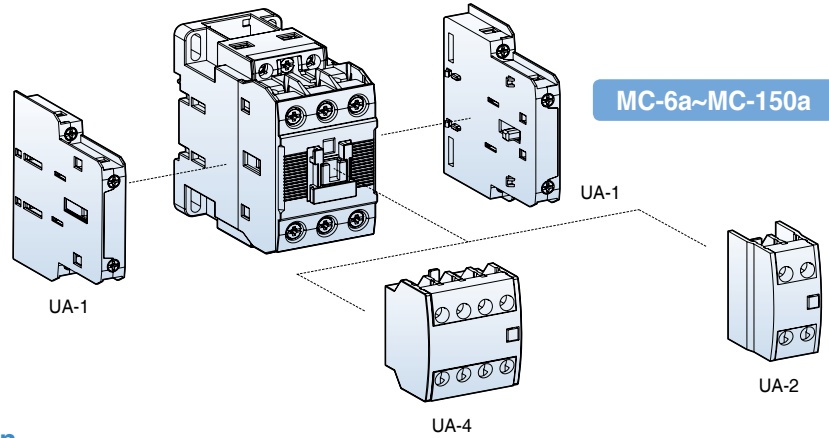

Selection

Type	Appearance	Pole	Composition		Contact arrangement	Mount	Weight
			NO	NC			
UA-1		2	1	1		Side	53g
UA-2		2	2 1 -	- 1 2		Front	28g
UA-4		4	4 3 2 1 -	- 1 2 3 4		Front	50g

Maximum combination of contact units

MC-6a~18a, 9b~22b (Max. 3a3b)	MC-32a~150a (Max. 4a4b)
UA-4(on front)+UA-1×1EA (1EA on one side)	UA-4(on front)+UA-1×2EA (1EA on both sides)
UA-2(on front)+UA-1×1EA (1EA on one side)	UA-2(on front)+UA-1×2EA (1EA on both sides)
UA-1×2EA (1EA on both sides)	UA-1×4EA (2EA on both sides) *For AC Coil

*To use UA-1, MC-9b~22b Type is available on only left side

Auxiliary contact units

- 2 pole
- Side mountable
- Common use for Metasol contactors from MC-185a to MC-2100a
- Auxiliary contact meet the requirements for mirror contacts in IEC 60947-4-1. Annex F
(A mirror contact is an auxiliary NC contact that cannot be closed simultaneously with a NO main contact)

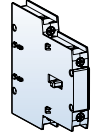
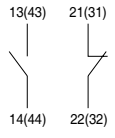

Selection

Type	Appearance	Pole	Composition		Contact arrangement	Mount	Weight
			a(NO)	b(NC)			
AU-100 AU-100E		2	1	1		Side	53g

Maximum combination of contact units

MC-185a~2100a (Max. 4a4b)
AU-100×4EA (2EA on both sides)
AU-100E×4EA (2EA on both sides)

Rating

Type		UA-1	UA-2, 4	AU-100	AU-100E	
Rated operation voltage (Ue)		600V	600V	600V	60V	
Rated insulation voltage (Ui)		600V	600V	600V	600V	
Rated impulse withstand voltage (Uimp)		6kV	6kV	6kV	6kV	
Rated frequency		50/60Hz	50/60Hz	50/60Hz	50/60Hz	
Contact sensibility	Voltage	DC 17V	DC 24V	DC 24V	DC 7V	
	Current	DC 5mA	DC 10mA	DC 10mA	DC 5mA	
	Rated thermal current (Ith, AC12 duty)	10A	16A	16A	1A	
Rated operation current	AC15 duty (A600)	120V	6A	6A	6A	AC/DC 24V 0.1A AC/DC 50V 0.01A
		240V	3A	3A	3A	
		380V	1.9A	1.9A	1.9A	
		480V	1.5A	1.5A	1.5A	
		500V	1.4A	1.4A	1.4A	
	DC13 duty (Q600)	600V	1.2A	1.2A	1.2A	
		125V	1.1A	1.1A	1.1A	
		250V	0.55A	0.55A	0.55A	
		400V	0.31A	0.31A	0.31A	
		500V	0.27A	0.27A	0.27A	
		600V	0.2A	0.2A	0.2A	
Rated Short-time withstand current	1s	100A	-	100A	-	
	0.5s	125A	-	120A	-	
	0.1s	145A	-	140A	-	
Electrical lifetime (mil. operations)	AC15 duty	220V	0.25	0.25	0.25	1
		440V	0.25	0.25	0.25	
	DC13 duty	220V	0.25	0.25	0.25	
		440V	0.25	0.25	0.25	
	Maximum operating cycles per hour		1800	1800	1200	
Conductor size (Solid, stranded)	AWG	18~10	18~10	18~10	18~10	
	(the max. number of conducts: 2) mm ²	1~2.5	1~2.5	1~2.5	1~2.5	

Installation

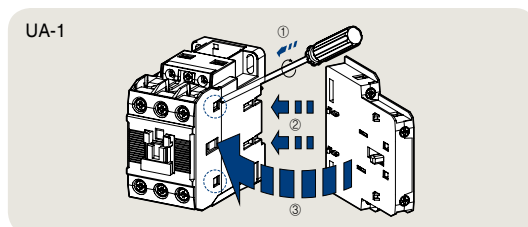

To install side mounting unit remove the indicated part in the circle in the fig. first. And then fit each part as shown. To separate push forward and pull.

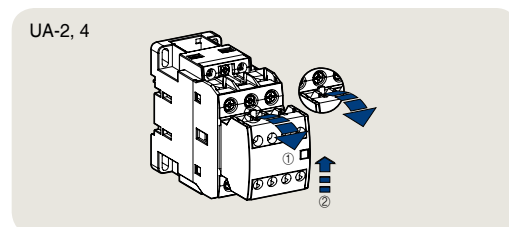

To install front mounting unit fit it on the upper part in the circle in the fig. first. And then fit each part of the front of the contactor and push it down. To separate pull the lever of the unit and push the unit upward.

Mechanical latch unit ML, AL

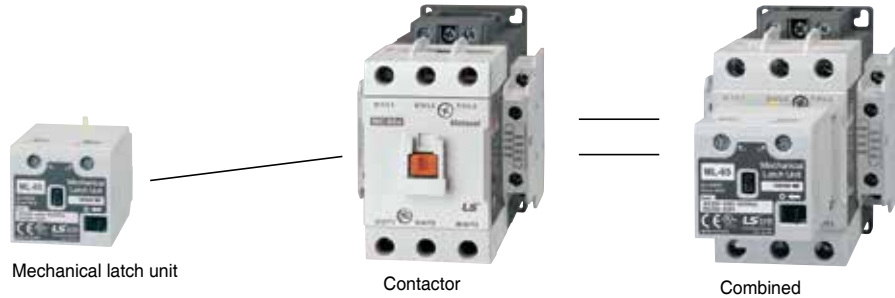

ML-65



Ratings

Applying contactors	Type	Coil voltage of latch unit													
MC-6a/L MC-9a/L MC-12a/L MC-18a/L MC-9b/L MC-12b/L MC-18b/L MC-22b/L MC-32a/L MC-40a/L MC-50a/L MC-65a/L	ML-65	<table border="1"> <thead> <tr> <th>Ordering voltage</th> <th>Operation voltage</th> </tr> </thead> <tbody> <tr> <td>AC 24V/ DC 24V</td> <td>AC 24V 50/60Hz, DC 24V</td> </tr> <tr> <td>AC 48V/ DC 48V</td> <td>AC 48V 50/60Hz, DC 48V</td> </tr> <tr> <td>AC 100V/DC 100V</td> <td>AC 100~127V 50/60Hz, DC 100V~125V</td> </tr> <tr> <td>AC 200V/DC 200V</td> <td>AC 200~240V 50/60Hz, DC 200V~220V</td> </tr> <tr> <td>AC 400V</td> <td>AC 380V~440V 50/60Hz</td> </tr> </tbody> </table>	Ordering voltage	Operation voltage	AC 24V/ DC 24V	AC 24V 50/60Hz, DC 24V	AC 48V/ DC 48V	AC 48V 50/60Hz, DC 48V	AC 100V/DC 100V	AC 100~127V 50/60Hz, DC 100V~125V	AC 200V/DC 200V	AC 200~240V 50/60Hz, DC 200V~220V	AC 400V	AC 380V~440V 50/60Hz	
Ordering voltage	Operation voltage														
AC 24V/ DC 24V	AC 24V 50/60Hz, DC 24V														
AC 48V/ DC 48V	AC 48V 50/60Hz, DC 48V														
AC 100V/DC 100V	AC 100~127V 50/60Hz, DC 100V~125V														
AC 200V/DC 200V	AC 200~240V 50/60Hz, DC 200V~220V														
AC 400V	AC 380V~440V 50/60Hz														
MC-75a/L MC-85a/L MC-100a/L MC-130a/L MC-150a/L	ML-150														
MC-185a/L, 225a/L	AL-225	<table border="1"> <thead> <tr> <th>Ordering voltage</th> <th>Operation voltage</th> </tr> </thead> <tbody> <tr> <td>AC 100V</td> <td>AC 100~127V 50/60Hz, DC 100~110V</td> </tr> <tr> <td>AC 200V</td> <td>AC 200~240V 50/60Hz, DC 200~220V</td> </tr> </tbody> </table>	Ordering voltage	Operation voltage	AC 100V	AC 100~127V 50/60Hz, DC 100~110V	AC 200V	AC 200~240V 50/60Hz, DC 200~220V							
Ordering voltage	Operation voltage														
AC 100V	AC 100~127V 50/60Hz, DC 100~110V														
AC 200V	AC 200~240V 50/60Hz, DC 200~220V														
MC-265a/L, 330a/L, 400a/L	AL-400														

* Coils for 24, 48, 100, 200V are AC / DC common.

* For using safely the product providing DC control power, Please consider that the maximum switching frequency should be less than 150 times/hour.

Note) Latch units for upto MC-150 are supplied separately. From MC-185 the units are assembled at factory.

To install

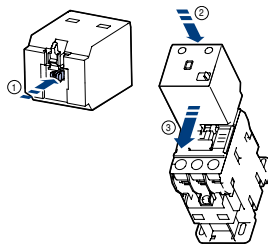

1. Push the black bar
2. Position the Latch on the top of the contactor
3. Pull in the direction of the arrow until snapping

To separate

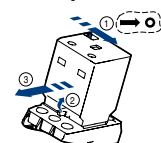

1. Pull the black lever in the direction of the arrow.
2. Pull up the yellow lever.
3. Push the latch in the direction of the arrow.

Delayed opening devices, AD

Delayed opening device prevents the inadvertent opening of a contactor in the event of a wide voltage drop or brief supply voltage interruptions of control power for 1 to 4 seconds.

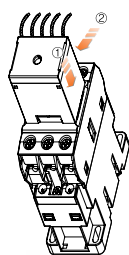

① Insult to ① way ② Push to ② way and assemble

Applying contactors	Type	Rated voltage	Durability		Performance
			Mechanical	Electrical	
MC-6a~40a, MC-9b~22b	AD-9	AC 110V / AC 220V	5 mil. operations	1 mil. operations	<ul style="list-style-type: none"> • Making/Breaking capacity at AC3 - Making current : min. 10xI_n - Breaking current : min. 8xI_n • Max. operating rate : 600 operations/hour • Delaying time : 1~4sec. • Capacitor durability 1) Operation : > 0.1 mil. operations 2) Cumulative charge life at AC 200/220V - 45°C or less: 80,000 hours - 50°C or less: 60,000 hours
MC-50a~100a	AD-50	AC 110V / AC 220V			
MC-130a~225a	AD-100	AC 100~240V			
MC-265a~400a	AD-300	AC 100~240V			
MC-500a~800a	AD-600	AC 100~127V / AC 200~240V			

* AD shall be used for DC type contactor

Electronic timer unit, UT

Applying contactors	Type	Rated voltage	Performance
MC-6a~150a MC-9b~22b	On delay	UT-1N	<ul style="list-style-type: none"> • Mounting: Head on • Contact: 1c • Time delay: 1 Sec~30 Sec On delay, Off delay • Frequency: AC 50/60Hz • Operation: Min. voltage 85%, Max. voltage 110% • Accuracy of setting time: ±20%
		UT-2N	
MR-4~8	Off delay	UT-1F	
		UT-2F	

Terminal cover units for contactors, AP

Applying contactors	Type	Remarks
MC-50a, 65a (65AF)	AP-50	2 pcs included
MC-75a, 85a, 100a(100AF)	AP-75	
MC-130a, 150a (150AF)	AP-130	
MC-185a, 225a (225AF)	AP-220	
MC-265a, 330a, 400a (400AF)	AP-400	
MC-500a, 630a, 800a (800AF)	AP-800	

Insulation barrier units, AI

Applying contactors	Type	Remarks
MC-130a, 150a (150AF)	AI-180	4 pcs required per contactor
MC-185a, 225a (225AF)		
MC-265a, 330a, 400a (400AF)	AI-800	
MC-500a, 630a, 800a, 1260a (800AF)	AI-800	
MC-1400a, 1700a, 2100a (2100AF)	AI-2100	

* The insulation barrier for MC-150a is available on the screw type only.

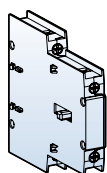

Interlock unit

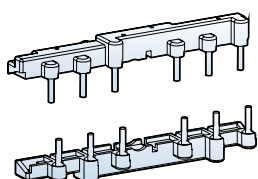

Wire kit

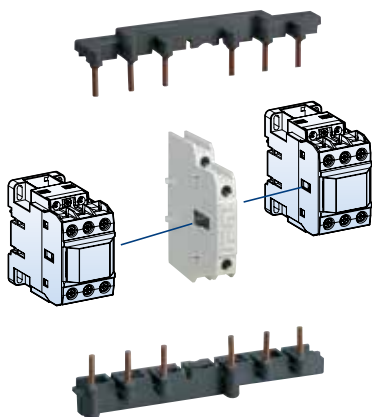

Interlocks

Component parts for assembling by customer

Interlock unit, UR-02 and AR-9 & Wire kit UW

UR-02 is a mechanical interlock unit and provides 2NC contacts for use in electrical interlocking

UW is used for making reversing circuit between two contactors.

Contactor	Pole	Wire kit		Interlock unit		Aux Contact	
		Type	Weight	Type	Weight		
MC-6a~18a	3P	UW-18	0.05kg	UR-02	0.06kg	2NC	
	4P	-	-				
MC-9b~22b	3P	UW-22	0.04kg			-	-
MC-32a~40a		UW-32	0.05kg				
MC-50a, 65a		UW-63	0.12kg				
MC-75a~100a		UW-95	0.33kg				
MC-130a~150a	-	-	-	-	-		
MC-22a~5a	4P	-	-	AR-9	0.05kg	-	

Rating of the contacts in the interlocks

Rated operation voltage	600V	
Rated insulation voltage	600V	
Rated frequency	50/60Hz	
Rated thermal current	10A	
Rated operation current		
AC15 duty (A600)	120V	6A
	240V	3A
	380V	1.9A
	480V	1.5A
	500V	1.4A
	600V	1.2A
DC13 duty (Q300)	125V	0.55A
	250V	0.27A

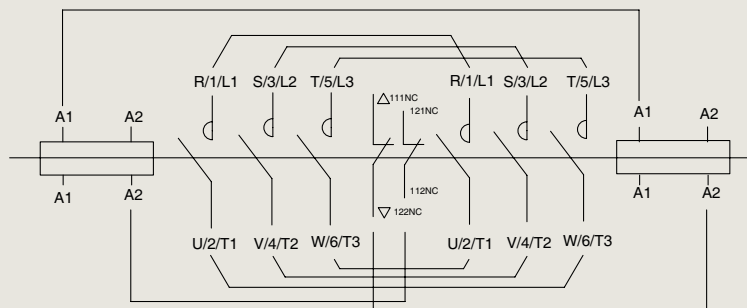

<MC-6aR ~ MC-150aR typical circuit diagram for reversing contactor>



AR-180

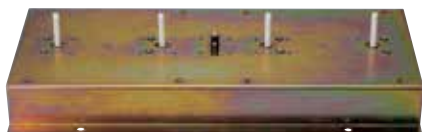

AR-600

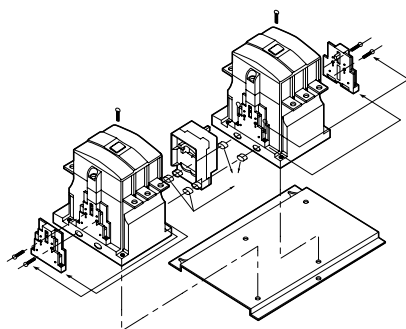

Interlock unit, AR-180 and AR-600

AR-180 and AR-600 are mechanical interlock units in which electrical contacts for use in electrical interlocking are not included. Please use the auxiliary contacts on the sides of the contactors for that purpose.

Contactor	Pole	Interlock unit	
		Type	Weight
MC-100a	4P	AR-180	0.09kg
MC-130a			
MC-150a			
MC-185a			
MC-225a			
MC-265a	3,4P	AR-600	15.2kg
MC-330a			
MC-400a			
MC-500a			
MC-630a	3,4P	AR-600	15.2kg
MC-800a			

*AR-600 3pole product is different fro, AR-600 4pole product in size.

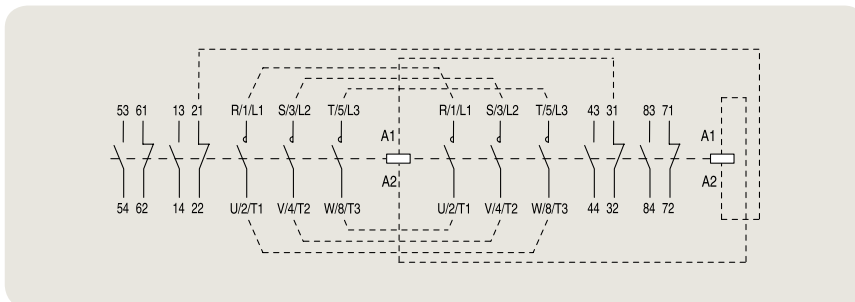

<MC-180aR ~ MC-800aR typical circuit diagram for reversing contactor>

Installation of Interlock and Wire kits

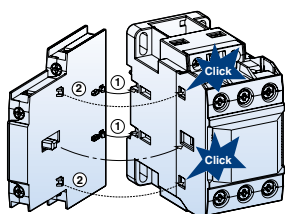

Install the interlock unit on the side of a contactor first. Fit each part as indicated in the fig.

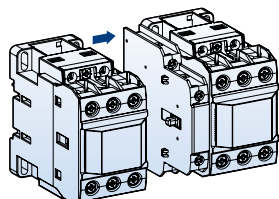

And then install the other contactor on the other side of the interlock unit as shown.

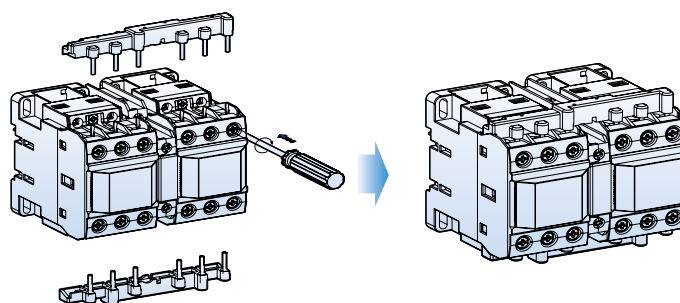

After installing interlock unit wiring kit can be assembled.

Wiring kit contains two molded wires - one for line side and the other for load side.

- In case of assembling Reversing contactor, please check the R, S, T/U, V, W mark on the contactor and Wire kit.

Surge unit



US Type



AS Type

It absorbs the surge arisen out of the coil of the contactor.

It can be installed simply to the contactor.

- Rated operation voltage (Ue): AC 24 ~ 440V / DC 24 ~ 125V
- Rated insulation voltage (Ui): 1000V
- Rated impulse withstand voltage (Uimp): 8kV
- Degree of protection: IP20
- Combination with 3Pole 6a/3~150a/3, 4Pole 32a/4~85a/4

US Type

Surge unit		Rated voltage		Internal elements spec.			Contactor
Type	Composition			V	R	C	
US-1	Varistor+RC	AC	24~48V	120V	100Ω	0.1μF	3Pole MC 6a~150a 9b~22b
US-2	Varistor+RC		100~125V	270V	100Ω	0.1μF	
US-3	Varistor+RC		200~240V	470V	100Ω	0.1μF	
US-4	Varistor+RC	DC	24~48V	120V	100Ω	0.47μF	
US-5	Varistor+RC		100~125V	270V	100Ω	0.47μF	
US-6	Varistor+RC		200~220V	470V	100Ω	0.47μF	
US-11	Varistor	AC/DC common	24~48V	120V	-	-	
US-12	Varistor		100~125V	270V	-	-	
US-13	Varistor		200~240V	470V	-	-	
US-14	Varistor		380~440V	1000V	-	-	
US-22	RC	AC	100~125V	-	56Ω	1μF	

Installation (US Type)

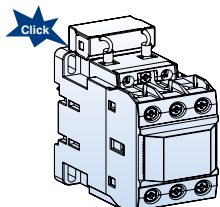
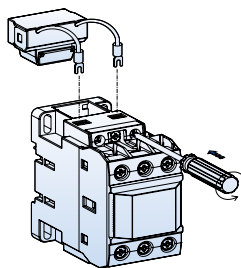

Connect the lead wires to the coil terminals of the contactor first. And then insert the body into the space of the contactor as shown above.

AS Type

Surge unit		Rated voltage		Internal elements spec.			Contactor
Type	Composition			V	R	C	
AS-1	Varistor+RC	AC	24~48V	120V	100Ω	0.1μF	3Pole MC 185a~800a 4Pole MC 22a/4~800a/4
AS-2	Varistor+RC		100~125V	270V	100Ω	0.1μF	
AS-3	Varistor+RC		200~240V	470V	100Ω	0.1μF	
AS-4	Varistor+RC	DC	24~48V	120V	100Ω	0.47μF	
AS-5	Varistor+RC		100~125V	270V	100Ω	0.47μF	
AS-6	Varistor+RC		200~220V	470V	100Ω	0.47μF	
AS-11	Varistor	AC/DC common	24~48V	120V	-	-	
AS-12	Varistor		100~125V	270V	-	-	
AS-13	Varistor		200~240V	470V	-	-	
AS-14	Varistor		380~440V	1000V	-	-	

Specitication of surge unit

Without surge unit	① With Varistor unit	② With CR+Varistor unit
Surge voltage, arise when the coil is off, may provoke mis-operation and damage in the circuit.	Varistor has an effect to cut down the peak voltage	Varistor has an effect to cut down the peak voltage and high frequency wave

Capacitor unit



Capacitor unit is connected to the terminals of the contactor to reduce the high inrush current.
IEC 60947-4-1 AC 6b

Type		AC-9 (1b)	AC-50 (1b)	AC-75 (1b)	
Rating thermal current (Ith)		16A	16A	16A	
Current	AC-15	Rated	120V	6	6
			240V	3	3
		Operational Current (A)	380V	1.9	1.9
			480V	1.5	1.5
			500V	1.4	1.4
	DC-13	Rated	600V	1.2	1.2
			125V	0.55	0.55
		Operational Current (A)	250V	0.27	0.27
			400V	0.15	0.15
			500V	0.13	0.13
		600V	0.1	0.1	

Note) - When the switch is closed condenser must be discharged before recharged. (Maximum residual voltage at terminals $\leq 50V$)
- To prevent short current, gG type fuse must be 1.5~2 times than rated current.

Features of capacitor unit (Pre-loading resistor)

- Damping resistor that can limit the inrush current upto $60 \times I_n$ is connected to the mechanism that closed earlier than the main contact of the contactor
- No heat loss by the serial resistor
- Eliminate the switching surge
- Improving the performance of the capacitor system

Operation sequence

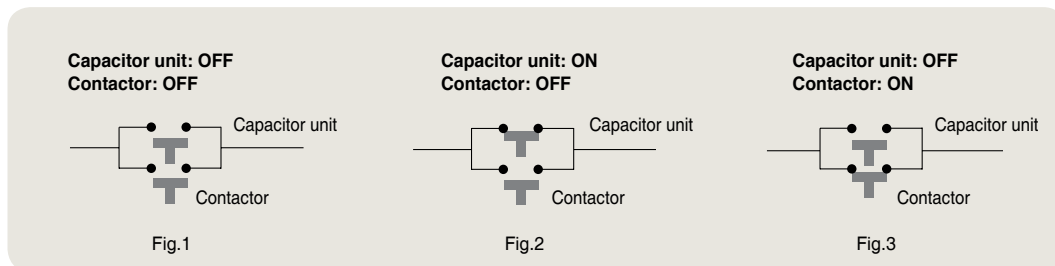

Note) Closing sequence: Fig.1 => Fig.2 => Fig.3
Opening sequence: Fig.3 => Fig.1

Replacement coils

To replace the existing coil to change voltage or repair.



Contactor	Coil voltage							
	AC coil						DC coil	
	AC 60Hz (V)		AC 50Hz (V)		AC 50/60Hz (V)		DC (V)	
MC-6a MC-9a MC-12a MC-18a MR-4, 6, 8	24	230	24	230	24	240		
	48	240	36	240	48	380		
	100	277	42	380	100	415		
	110	380	48	400	110	440		
	120	440	80	415	120	500		
	200	480	100	440	200	550		
	208	600	110	500	220			
	220		220	550	230			
MC-9b MC-12b MC-18b MC-22b	24	230	24	230	24	240		
	48	240	36	240	48	380		
	100	277	42	380	100	415		
	110	380	48	400	110	440		
	120	440	80	415	120	500		
	200	480	100	440	200	550		
	208	600	110	500	220			
	220		220	550	230			
MC-32a MC-40a	24	230	24	230	24	240	12	110
	48	240	36	240	48	380	20	125
	100	277	42	380	100	415	24	200
	110	380	48	400	110	440	48	220
	120	440	80	415	120	500	60	250
	200	480	100	440	200	550	80	
	208	600	110	500	220		100	
	220		220	550	230			
MC-50a MC-65a	24	230	24	230	24	240	12	110
	48	240	36	240	48	380	20	125
	100	277	42	380	100	415	24	200
	110	380	48	400	110	440	48	220
	120	440	80	415	120	500	60	250
	200	480	100	440	200	550	80	
	208	600	110	500	220		100	
	220		220	550	230			
MC-75a MC-85a MC-100a	24	230	24	230	24	240	12	110
	48	240	36	240	48	380	20	125
	100	277	42	380	100	415	24	200
	110	380	48	400	110	440	48	220
	120	440	80	415	120	500	60	250
	200	480	100	440	200	550	80	
	208	600	110	500	220		100	
	220		220	550	230			
MC-130a MC-150a					24	220~240	24	110
					48	300	48	220
					100~240	380~440	70~110	
					110~120	500	100~220	

Replacement process

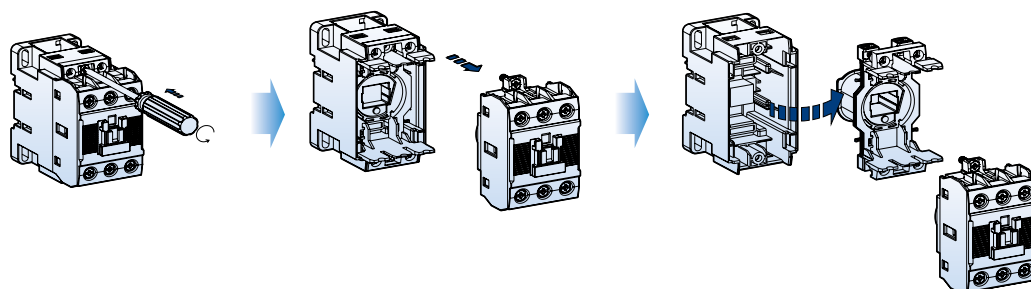



To replace the existing coil to change voltage or repair.

Contactor	Coil voltage	
	AC/DC common coil (V)	AC coil (V)
MC-185a MC-225a	24 48 100~240/100~220	300 400 500
MC-300a MC-400a	100~240/100~220	400 500
MC-500a MC-630a MC-800a	100/100 200/200	300 400 500
MC-1260a	100~240/100~220	-
MC-1400a MC-1700a MC-2100a	100~240/100~220	-

Safety cover (Option)

To prevent arc from coming out from the contactor
 To protect from unintended manual operation
 To prevent dust from entering into the inside of the contactor

Type	Contactor
AP-9	MC-6a~150a
AP-185	MC-185a~800a

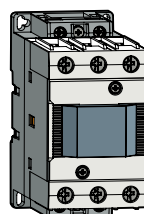

Overload relays

General descriptions

Type MT, bimetal-style, overload relays are designed to protect AC circuits and motors against overloads, phase failure, long starting times and prolonged stalling of the motor.

Four versions are available according to the protection function and trip class as below.

1. Non-differential: 3pole-2bimetal(heater) and trip class 10A
2. Non-differential: 3pole-3bimetal(heater) and trip class 10A
3. Differential: 3pole-3bimetal(heater) and trip class 10A
4. Differential: 3pole-3bimetal(heater) and trip class 20

Configuration of the front

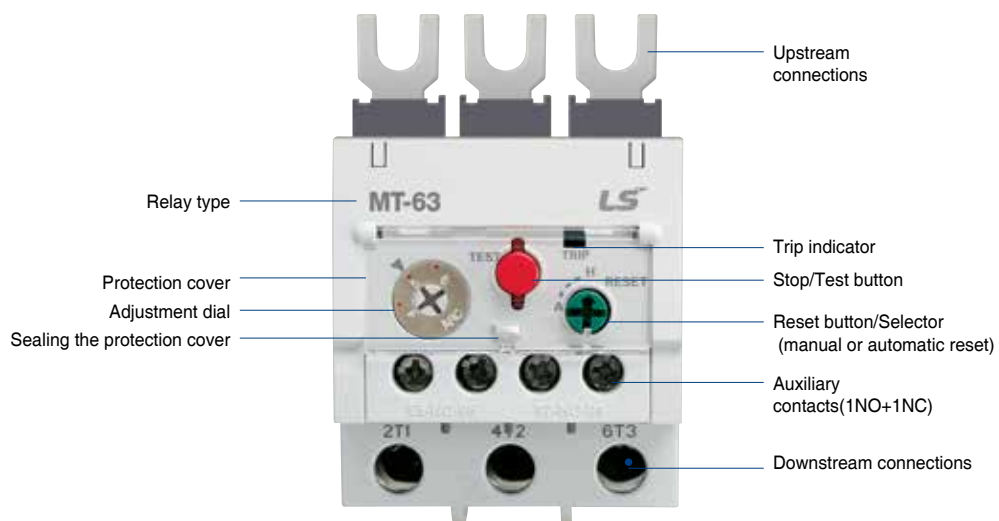

MT-12

MT-32

MT-63

MT-95



Environment and auxiliary circuit

Environment			MT-12~800
Standards			IEC/EN 60947-1, IEC/EN 60947-4-1
Certifications			CE, CSA, UL, CCC
Rated operation voltage			Max. 690V
Rated insulation voltage			690V
Rated frequency			50/60Hz
Degree of protection (Conforming to IEC 60 529)			IP 20
Ambient air temperature		Storage	-30 ~ +65°C
		Operation	-25 ~ +60°C (MT refer to Graph)
Mounting position			Vertical plane
Shock resistance (Conforming to IEC 68-2-7)			15gn - 11ms
Vibration resistance (Conforming to IEC68-2-6)			6G
Insulation strength (Conforming to IEC 255-5)			6kV
Rated impulse withstand voltage (Conforming to IEC 801-5)			6kV
Auxiliary contacts characteristics			
Composition			1NO +1NC
Rated thermal current			5A
Rated operation current			C600, R300
AC15 duty		120V	1.5A
(C600)		240V	0.75A
		380V	0.47A
		480V	0.375A
		500V	0.35A
		600V	0.3A
DC13 duty		120V	0.22A
(R300)		240V	0.1A
Connecting conductor		Size	18AWG /1mm ²
Connection to screw clamp terminals		Type	65/75°C Cu-wire

MT-150



MT-225



MT-400

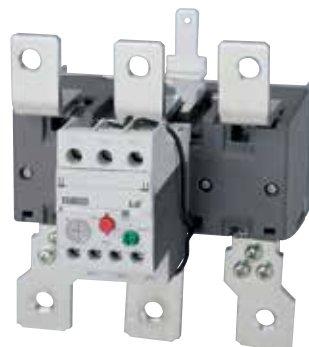

MT-800



Overload relay specifications

MT type Thermal Overload Relays

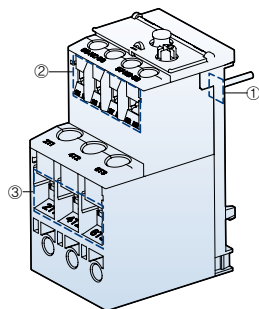

- ① Main terminals/upstream
- ② Main terminals/downstream
- ③ Auxiliary terminals

Frame size		
Trip class		
Type	Non-differential(3P-2 heater) Non-differential(3P-3 heater) Differential type	
Terminals	Main-upstream Main-downstream Auxiliary	
Number of poles		
Rated operational voltage (Ue)		
Rated insulation voltage (Ui)		
Rated impulse voltage (Uimp)		
Degree of protection (IEC 60 529)		
Temperature compensation (°C)		
Functions	Trip indicating Stop Test Manual/Automatic Reset	
Setting range(A)		
Nominal current rating	Wire size	
	mm ²	AWG
0.14	1	18
0.21		
0.33		
0.52		
0.82		
1.3		
2.1		
3.3		
5		
6.5		
7.5	1~1.5	18~16
8.5		
11	1.5~2.5	16~14
15	2.5	14~12
19	2.5~4	12~10
21.5		
27	4~6	10
30	4~10	10~8
34	6~10	10~8
42	10	8
54		
65		
74	16~25	6~4
83	25~35	4~3
90		
Applied contactors		
Separate mounting unit		

18AF	
10A	20
MT-12/2H□S	-
MT-12/3H□S	-
MT-12/3K□S	MT-12/3D□S
Screw clamp	
Screw clamp	
Screw clamp	
3	
690V	
Up to 690V	
6kV	
IP 20	
-5~+40°C	
■	
-	
■	
■	
0.1~18A	1~18A
0.1~0.16	
0.16~0.25	
0.25~0.4	
0.4~0.63	
0.63~1	
1~1.6	1~1.6
1.6~2.5	1.6~2.5
2.5~4	2.5~4
4~6	4~6
5~8	5~8
6~9	6~9
7~10	7~10
9~13	9~13
12~18	12~18
MC-6a, 9a, 12a, 18a	
UZ-12	

Note : Screw clamp and Lug types are available for the main terminals of 65AF, 100AF and 150AF relays.
The other AF relays provide Screw clamp types only.



40AF

10A	20
MT-32/2H□S	-
MT-32/3H□S	-
MT-32/3K□S	MT-32/3D□S
Screw clamp	
Screw clamp	
Screw clamp	
3	
690V	
Up to 690V	
6kV	
IP 20	
-5~+40°C	

0.1~40A	1~40A
---------	-------

0.1~0.16	
0.16~0.25	
0.25~0.4	
0.4~0.63	
0.63~1	
1~1.6	1~1.6
1.6~2.5	1.6~2.5
2.5~4	2.5~4
4~6	4~6
5~8	5~8
6~9	6~9
7~10	7~10
9~13	9~13
12~18	12~18
16~22	16~22
18~25	18~25
22~32	22~32
-	-
28~40	28~40

MC-9b, 12b, 18b, 22b, 32a, 40a
UZ-32



65AF

10A	20
MT-63/2H□S/L	-
MT-63/3H□S/L	-
MT-63/3K□S/L	MT-63/3D□S/L
Screw/Lug clamp	
Screw/Lug clamp	
Screw clamp	
3	
690V	
Up to 690V	
6kV	
IP 20	
-5~+40°C	

4~65A	
-------	--

4~6	4~6
5~8	5~8
6~9	6~9
7~10	7~10
9~13	9~13
12~18	12~18
16~22	16~22
18~25	18~25
-	-
24~36	24~36
28~40	28~40
34~50	34~50
45~65	45~65

MC-50a, 65a
UZ-63S/L



100AF

10A	20
MT-95/2H□S/L	-
MT-95/3H□S/L	-
MT-95/3K□S/L	MT-95/3D□S/L
Screw/Lug clamp	
Screw/Lug clamp	
Screw clamp	
3	
690V	
Up to 690V	
6kV	
IP 20	
-5~+40°C	

7~100A	
--------	--

7~10	7~10
9~13	9~13
12~18	12~18
16~22	16~22
18~25	18~25
-	-
24~36	24~36
28~40	28~40
34~50	34~50
45~65	45~65
54~75	54~75
63~85	63~85
70~95	70~95
80~100	80~100

MC-75a, 85a, 100a
UZ-95S/L

Overload relay specifications

MT type Thermal Overload Relays

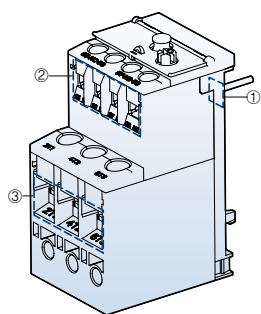

- ① Main terminals/upstream
- ② Main terminals/downstream
- ③ Auxiliary terminals



Frame size		
Trip class		
Type	Non-differential(3P-2 heater)	
	Non-differential(3P-3 heater)	
	Differential type	
Terminals	Main-upstream	
	Main-downstream	
	Auxiliary	
Number of poles		
Rated operational voltage (Ue)		
Rated insulation voltage (Ui)		
Rated impulse voltage (Uimp)		
Degree of protection (IEC 60 529)		
Temperature compensation (°C)		
Functions	Trip indicating	
	Stop	
	Test	
	Manual/Automatic Reset	
Setting range(A)		
Nominal current rating	Wire size	
	mm ²	AWG
42	10	8
55	16	6
65	25	4
74	25	4
80	35	3
93	35	2
107	50	1
113	50	1
130	50	0
130	70	00
153	95	000
200	120	250
265	185	350
350	240	500
515	185 × 2n	350 × 2n
660	240 × 2n	300 × 3n
Applied contactors		
Separate mounting unit		

150AF	
10A	20
MT-150/2H□S/L	-
MT-150/3H□S/L	-
MT-150/3K□S/L	MT-150/3D□S/L
Screw/Lug clamp	
Screw/Lug clamp	
Screw clamp	
3	
690V	
690V	
6kV	
IP 20	
-5~+40°C	
■	
■	
■	
■	
34~150A	34~150A
34~50	
45~65	
54~75	
63~85	
-	
80~105	
-	
95~130	
110~150	
MC-130a, 150a	
UZ-150S/L	

Note : Screw clamp and Lug types are available for the main terminals of 65AF, 100AF and 150AF relays.
The other AF relays provide Screw clamp types only.



225AF	
10A	20
MT-225/2H□S	-
MT-225/3H□S	-
MT-225/3K□S	MT-225/3D□S
Screw clamp	
Screw clamp	
Screw clamp	
3	
690V	
690V	
6kV	
IP 20	
-5~+40°C	
■	
■	
■	
■	
65~100	
-	
85~125	
-	
-	
100~160	
120~185	
160~240	
MC-185a, 225a	
-	

400AF	
10A	20
MT-400/2H□S	-
MT-400/3H□S	-
MT-400/3K□S	MT-400/3D□S
Screw clamp	
Screw clamp	
Screw clamp	
3	
690V	
690V	
6kV	
IP 20	
-5~+40°C	
■	
■	
■	
■	
85~125	
-	
-	
100~160	
120~185	
160~240	
200~330	
260~400	
MC-265a, 330a, 400a	
-	

800AF	
10A	20
MT-800/2H□S	-
MT-800/3H□S	-
MT-800/3K□S	MT-800/3D□S
Screw clamp	
Screw clamp	
Screw clamp	
3	
690V	
690V	
6kV	
IP 20	
-5~+40°C	
■	
■	
■	
■	
200~800A	
200~800A	
-	
-	
200~300	
260~400	
400~600	
520~800	
MC-500a, 630a, 800a	
-	

Overload relay operation

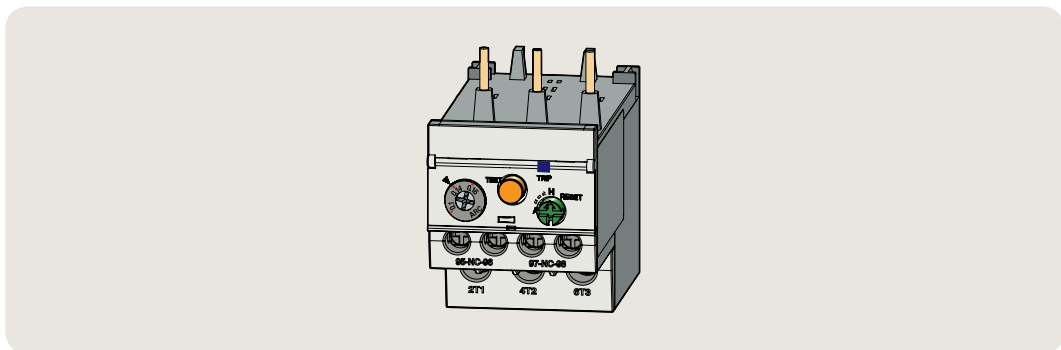
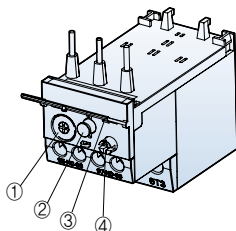

1. Adjustment dial



Before adjusting the dial open the protection cover.
Current setting can be done easily by using (+) or (-) driver.
Do not rotate the dial out of the setting range.

2. Stop/Test button

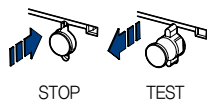

STOP function is executed by pushing the button, which causes the next sequence.
In case of operation test pull this button.

3. Trip indicator

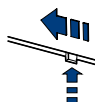

If relay is tripped it comes out.

4. Reset button/Selector

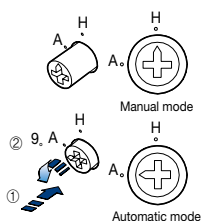

Using a driver the reset mode can be set.
In case of Manual mode(H) push the button to reset the relay.
To change to Automatic mode(A) from Manual mode push the button and rotate as shown in the fig.

5. Auxiliary contact operation

Terminal no.	Normal	STOP	TEST/TRIP	RESET
NC 95-96				
NO 97-98				

Accessories for overload relay

Separate mounting units

These accessories are used to mount the relays separately from contactors. If a relay is combined with a unit, it can be mounted on DIN rail or panel by fixing screws.



Relay	Unit	
	Type	Weight
MT-12/2H□ MT-12/3H□ MT-12/3K□ MT-12/3D□	UZ-12	35g
MT-32/2H□ MT-32/3H□ MT-32/3K□ MT-32/3D□	UZ-32	68g
MT-63/2H□ MT-63/3H□ MT-63/3K□ MT-63/3D□	UZ-63S/L	134g
MT-95/2H□ MT-95/3H□ MT-95/3K□ MT-95/3D□	UZ-95S/L	230g
MT-150/2H□ MT-150/3H□ MT-150/3K□ MT-150/3D□	UZ-150S/L	284g

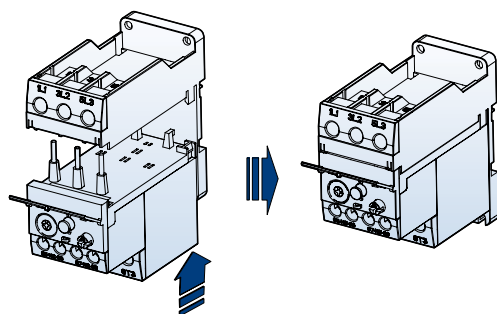

Terminal cover units for overload relays



Relay	Remarks
MT-225	2 pcs
MT-400	

Accessories for overload relay

Remote reset units

These accessories are used to reset the relays on the panel door.



Type	Cable length (L)
UM-4R	400 mm
UM-5R	500 mm
UM-6R	600 mm

1. Make the reset bar straight at least 55mm from the panel door and 35mm from the bracket.
2. The bending radius of the flexible reset bar should not be less than 15mm.

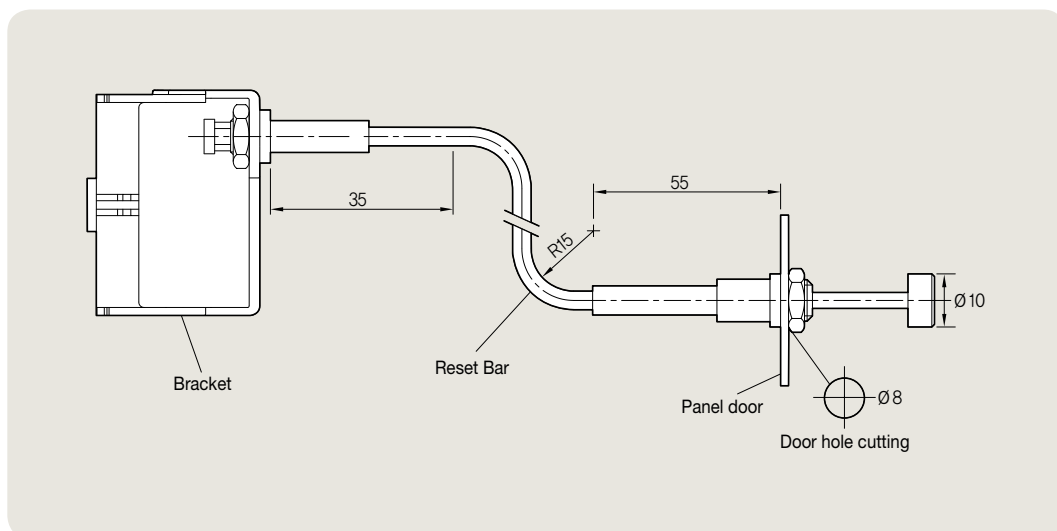

Installation

1. Fit the bracket with the relay as indicated(*1) below.
2. Separate Nut(*3) and Head cap(*4) from the reset bar first.
Insert the reset bar into the panel hole and then fix it with the Nut and Head.
3. To separate the bracket from the relay lift the *2 part as shown in the fig.

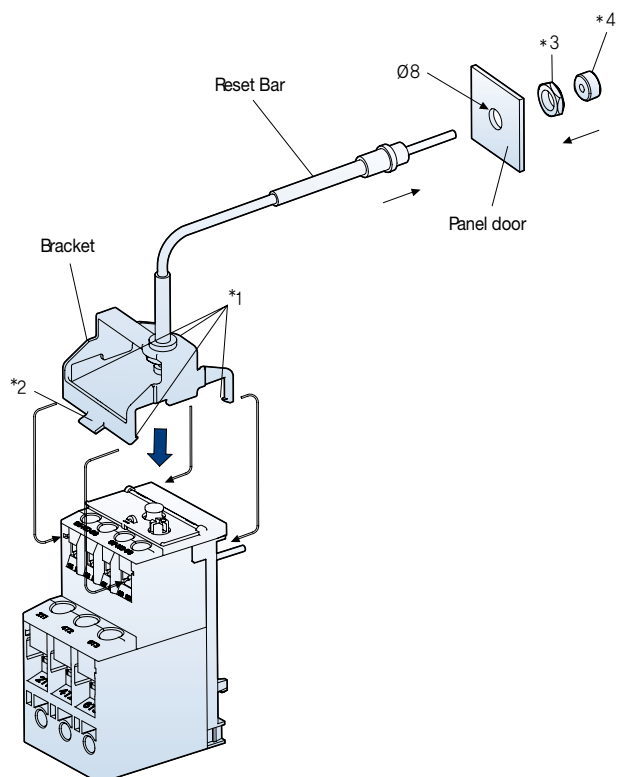
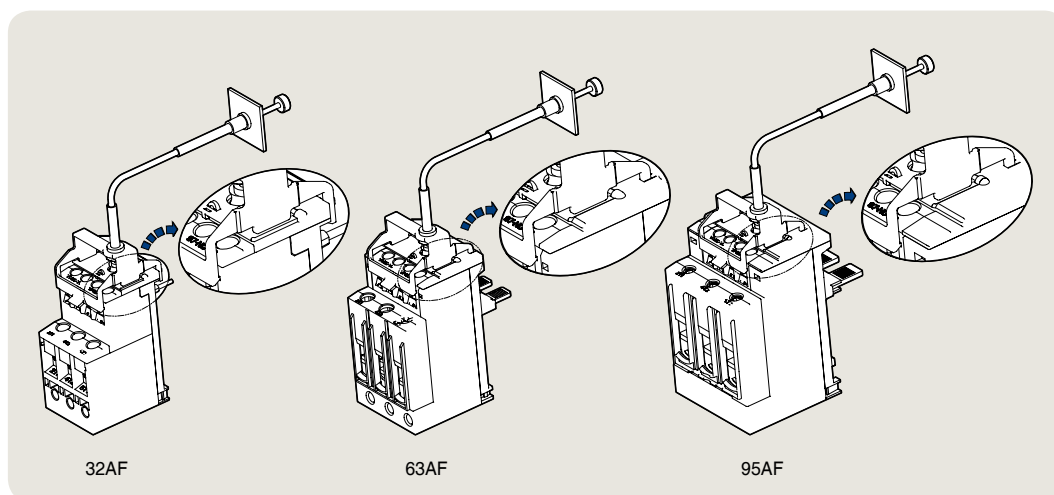

Accessories for overload relay

Remote reset units

MT-32

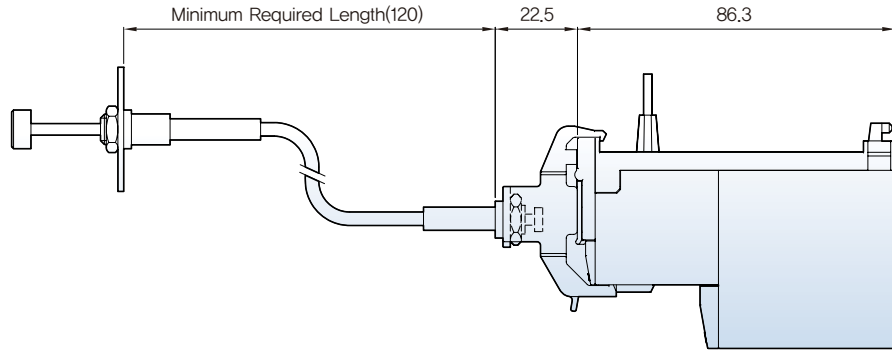

MT-63

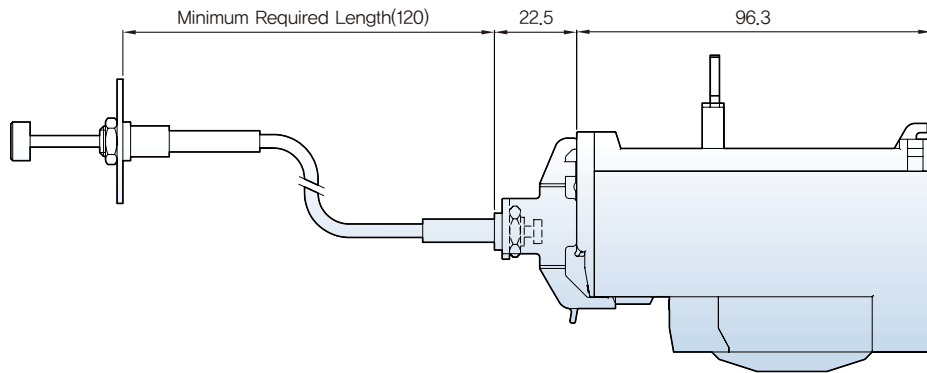

MT-95

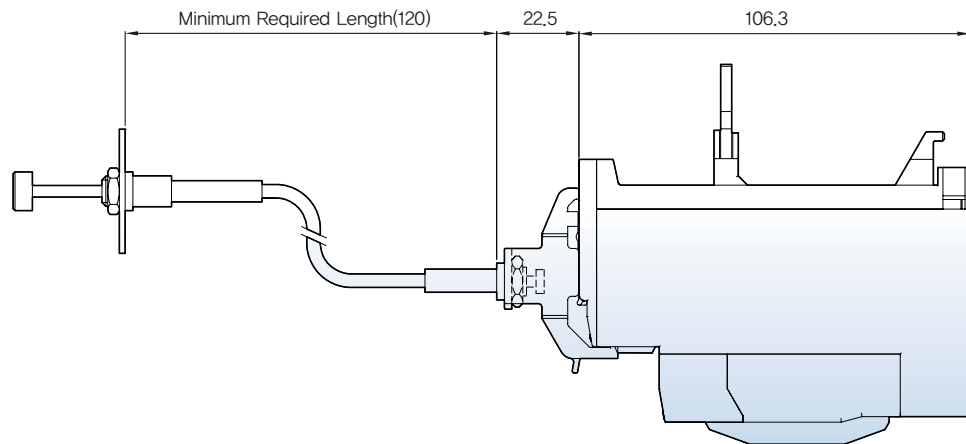

Remote reset units

MT-150

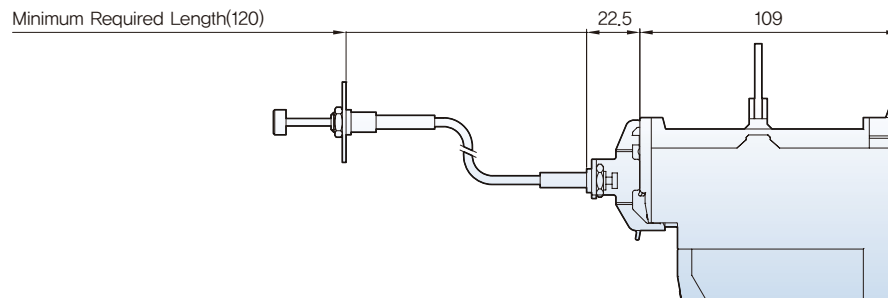

MT-225

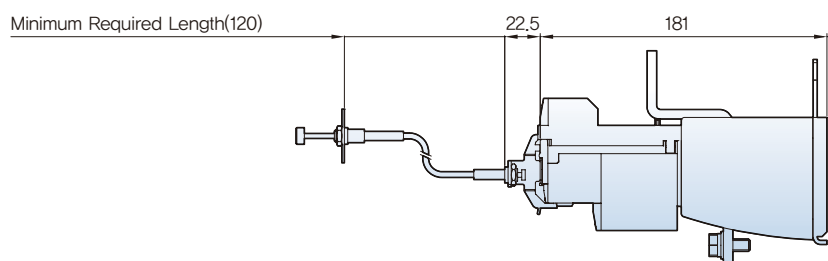

MT-400

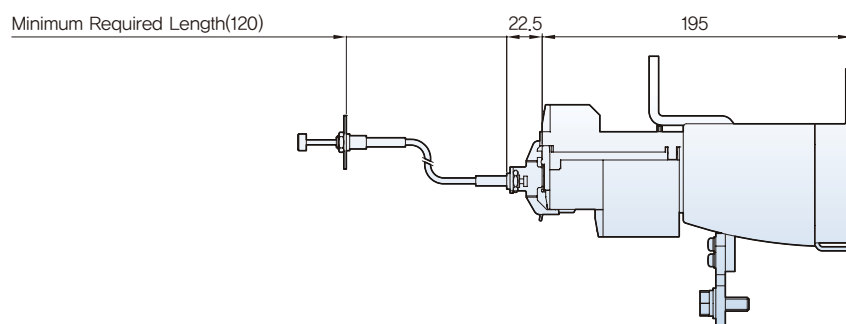

MT-800

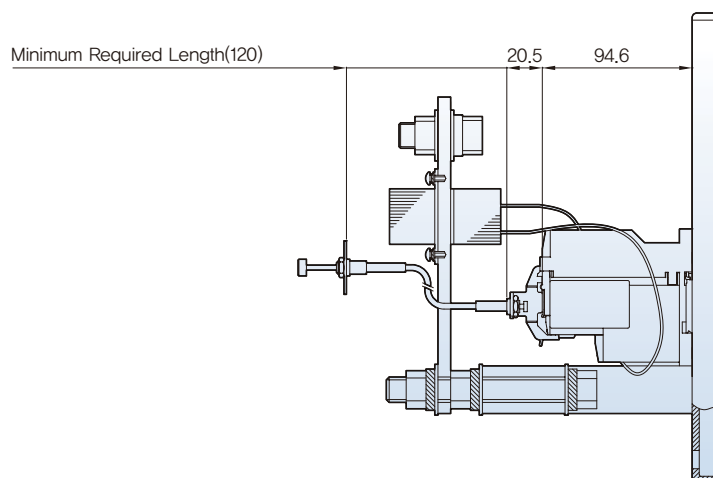

Overload relay ordering types

Trip class 10A

Terminal type: Screw

Degree of protection: IP20

MT-12



MT-12/□

Setting range (A)	Ordering type			Contactor	Separate mounting unit
	Non-differential (3P-2 heater)	Non-differential (3P-3 heater)	Differential		
0.1~0.16	MT-12/2H0.14	MT-12/3H0.14	MT-12/3K0.14	MC-6a MC-9a MC-12a MC-18a	UZ-12
0.16~0.25	MT-12/2H0.21	MT-12/3H0.21	MT-12/3K0.21		
0.25~0.4	MT-12/2H0.33	MT-12/3H0.33	MT-12/3K0.33		
0.4~0.63	MT-12/2H0.52	MT-12/3H0.52	MT-12/3K0.52		
0.63~1	MT-12/2H0.82	MT-12/3H0.82	MT-12/3K0.82		
1~1.6	MT-12/2H1.3	MT-12/3H1.3	MT-12/3K1.3		
1.6~2.5	MT-12/2H2.1	MT-12/3H2.1	MT-12/3K2.1		
2.5~4	MT-12/2H3.3	MT-12/3H3.3	MT-12/3K3.3		
4~6	MT-12/2H5	MT-12/3H5	MT-12/3K5		
5~8	MT-12/2H6.5	MT-12/3H6.5	MT-12/3K6.5		
6~9	MT-12/2H7.5	MT-12/3H7.5	MT-12/3K7.5		
7~10	MT-12/2H8.5	MT-12/3H8.5	MT-12/3K8.5		
9~13	MT-12/2H11	MT-12/3H11	MT-12/3K11		
12~18	MT-12/2H15	MT-12/3H15	MT-12/3K15		

MT-32



MT-32/□

Setting range (A)	Ordering type			Contactor	Separate mounting unit	
	Non-differential (3P-2 heater)	Non-differential (3P-3 heater)	Differential			
0.1~0.16	MT-32/2H0.14	MT-32/3H0.14	MT-32/3K0.14	MC-9b MC-12b MC-18b MC-22b MC-32a MC-40a	UZ-32	
0.16~0.25	MT-32/2H0.21	MT-32/3H0.21	MT-32/3K0.21			
0.25~0.4	MT-32/2H0.33	MT-32/3H0.33	MT-32/3K0.33			
0.4~0.63	MT-32/2H0.52	MT-32/3H0.52	MT-32/3K0.52			
0.63~1	MT-32/2H0.82	MT-32/3H0.82	MT-32/3K0.82			
1~1.6	MT-32/2H1.3	MT-32/3H1.3	MT-32/3K1.3			
1.6~2.5	MT-32/2H2.1	MT-32/3H2.1	MT-32/3K2.1			
2.5~4	MT-32/2H3.3	MT-32/3H3.3	MT-32/3K3.3			
4~6	MT-32/2H5	MT-32/3H5	MT-32/3K5			
5~8	MT-32/2H6.5	MT-32/3H6.5	MT-32/3K6.5			
6~9	MT-32/2H7.5	MT-32/3H7.5	MT-32/3K7.5			
7~10	MT-32/2H8.5	MT-32/3H8.5	MT-32/3K8.5			
9~13	MT-32/2H11	MT-32/3H11	MT-32/3K11			
12~18	MT-32/2H15	MT-32/3H15	MT-32/3K15			
16~22	MT-32/2H19	MT-32/3H19	MT-32/3K19			
18~25	MT-32/2H21.5	MT-32/3H21.5	MT-32/3K21.5			
22~32	MT-32/2H27	MT-32/3H27	MT-32/3K27			
28~40	MT-32/2H34	MT-32/3H34	MT-32/3K34			

Trip class 10A

Terminal type: Screw(S), Lug(L)

Degree of protection: IP20

MT-63



MT-63/□S



MT-63/□L

Setting range (A)	Ordering type			Contactor	Separate mounting unit
	Non-differential (3P-2 heater)	Non-differential (3P-3 heater)	Differential		
4-6	MT-63/2H5S/L	MT-63/3H5S/L	MT-63/3K5S/L	MC-50a MC-65a	UZ-63S/L
5-8	MT-63/2H6.5S/L	MT-63/3H6.5S/L	MT-63/3K6.5S/L		
6-9	MT-63/2H7.5S/L	MT-63/3H7.5S/L	MT-63/3K7.5S/L		
7-10	MT-63/2H8.5S/L	MT-63/3H8.5S/L	MT-63/3K8.5S/L		
9-13	MT-63/2H11S/L	MT-63/3H11S/L	MT-63/3K11S/L		
12-18	MT-63/2H15S/L	MT-63/3H15S/L	MT-63/3K15S/L		
16-22	MT-63/2H19S/L	MT-63/3H19S/L	MT-63/3K19S/L		
18-25	MT-63/2H21.5S/L	MT-63/3H21.5S/L	MT-63/3K21.5S/L		
24-36	MT-63/2H30S/L	MT-63/3H30S/L	MT-63/3K30S/L		
28-40	MT-63/2H34S/L	MT-63/3H34S/L	MT-63/3K34S/L		
34-50	MT-63/2H42S/L	MT-63/3H42S/L	MT-63/3K42S/L		
45-65	MT-63/2H55S/L	MT-63/3H55S/L	MT-63/3K55S/L		

MT-95



MT-95/□S



MT-95/□L

Setting range (A)	Ordering type			Contactor	Separate mounting unit
	Non-differential (3P-2 heater)	Non-differential (3P-3 heater)	Differential		
7-10	MT-95/2H8.5S/L	MT-95/3H8.5S/L	MT-95/3K8.5S/L	MC-75a MC-85a MC-100a	UZ-95S/L
9-13	MT-95/2H11S/L	MT-95/3H11S/L	MT-95/3K11S/L		
12-18	MT-95/2H15S/L	MT-95/3H15S/L	MT-95/3K15S/L		
16-22	MT-95/2H19S/L	MT-95/3H19S/L	MT-95/3K19S/L		
18-25	MT-95/2H21.5S/L	MT-95/3H21.5S/L	MT-95/3K21.5S/L		
24-36	MT-95/2H30S/L	MT-95/3H30S/L	MT-95/3K30S/L		
28-40	MT-95/2H34S/L	MT-95/3H34S/L	MT-95/3K34S/L		
34-50	MT-95/2H42S/L	MT-95/3H42S/L	MT-95/3K42S/L		
45-65	MT-95/2H55S/L	MT-95/3H55S/L	MT-95/3K55S/L		
54-75	MT-95/2H65S/L	MT-95/3H65S/L	MT-95/3K65S/L		
63-85	MT-95/2H74S/L	MT-95/3H74S/L	MT-95/3K74S/L		
70-95	MT-95/2H83S/L	MT-95/3H83S/L	MT-95/3K83S/L		
80-100	MT-95/2H90S/L	MT-95/3H90S/L	MT-95/3K90S/L		

MT-150



MT-150/□S

Setting range (A)	Ordering type			Contactor	Separate mounting unit
	Non-differential		Differential		
	(3P-2 heater)	(3P-3 heater)			
34-50	MT-150/2H42S/L	MT-150/3H42S/L	MT-150/3K42S/L	MC-130a MC-150a	UZ-150S/L
45-65	MT-150/2H55S/L	MT-150/3H55S/L	MT-150/3K55S/L		
54-75	MT-150/2H65S/L	MT-150/3H65S/L	MT-150/3K65S/L		
63-85	MT-150/2H74S/L	MT-150/3H74S/L	MT-150/3K74S/L		
80-105	MT-150/2H93S/L	MT-150/3H93S/L	MT-150/3K93S/L		
95-130	MT-150/2H113S/L	MT-150/3H113S/L	MT-150/3K113S/L		
110-150	MT-150/2H130S/L	MT-150/3H130S/L	MT-150/3K130S/L		

Overload relay ordering types

Trip class 10A

Terminal type: Screw

Degree of protection: IP20

MT-225

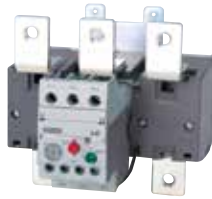

MT-225/□

Setting range (A)	Ordering type			Contactor	Remarks
	Non-differential		Differential		
	(3P-2 heater)	(3P-3 heater)			
65~100	MT-225/2H80	MT-225/3H80	MT-225/3K80	MC-185a MC-225a	-
85~125	MT-225/2H107	MT-225/3H107	MT-225/3K107		
100~160	MT-225/2H130	MT-225/3H130	MT-225/3K130		
120~185	MT-225/2H153	MT-225/3H153	MT-225/3K153		
160~240	MT-225/2H200	MT-225/3H200	MT-225/3K200		

MT-400



MT-400/□

Setting range (A)	Ordering type			Contactor	Remarks
	Non-differential		Differential		
	(3P-2 heater)	(3P-3 heater)			
85~125	MT-400/2H107	MT-400/3H107	MT-400/3K107	MC-265a MC-330a MC-400a	-
100~160	MT-400/2H130	MT-400/3H130	MT-400/3K130		
120~185	MT-400/2H153	MT-400/3H153	MT-400/3K153		
160~240	MT-400/2H200	MT-400/3H200	MT-400/3K200		
200~330	MT-400/2H265	MT-400/3H265	MT-400/3K265		
260~400	MT-400/2H350	MT-400/3H350	MT-400/3K350		

MT-800



MT-800/□

Setting range (A)	Ordering type			Contactor	Remarks
	Non-differential		Differential		
	(3P-2 heater)	(3P-3 heater)			
200~330	MT-800/2H265	MT-800/3H265	MT-800/3K265	MC-500a MC-630a MC-800a	-
260~400	MT-800/2H350	MT-800/3H350	MT-800/3K350		
400~630	MT-800/2H515	MT-800/3H515	MT-800/3K515		
520~800	MT-800/2H660	MT-800/3H660	MT-800/3K660		

Trip class 20

Terminal type: Screw

Degree of protection: IP20

MT-12



MT-12/3D□

Setting range (A)	Ordering type	Contactor	Separate mounting unit
	Differential		
1~1.6	MT-12/3D1.3	MC-6a MC-9a MC-12a MC-18a	UZ-12
1.6~2.5	MT-12/3D2.1		
2.5~4	MT-12/3D3.3		
4~6	MT-12/3D5		
5~8	MT-12/3D6.5		
6~9	MT-12/3D7.5		
7~10	MT-12/3D8.5		
9~13	MT-12/3D11		
12~18	MT-12/3D15		

MT-32



MT-32/3D□

Setting range (A)	Ordering type	Contactor	Separate mounting unit	
	Differential			
1~1.6	MT-32/3D1.3	MC-9b MC-12b MC-18b MC-22b MC-32a MC-32a MC-40a	UZ-32	
1.6~2.5	MT-32/3D2.1			
2.5~4	MT-32/3D3.3			
4~6	MT-32/3D5			
5~8	MT-32/3D6.5			
6~9	MT-32/3D7.5			
7~10	MT-32/3D8.5			
9~13	MT-32/3D11			
12~18	MT-32/3D15			
16~22	MT-32/3D19			
18~25	MT-32/3D21.5			
22~32	MT-32/3D27			
28~40	MT-32/3D34			UZ-32(34A)

Overload relay ordering types

Trip class 20

Terminal type: Screw(S), Lug(L)

Degree of protection: IP20

MT-63



MT-63/ S



MT-63/ L

Setting range (A)	Ordering type	Contactor	Separate mounting unit
	Differential		
4-6	MT-63/3D5S/L	MC-50a MC-65a	UZ-63S/L
5-8	MT-63/3D6.5S/L		
6-9	MT-63/3D7.5S/L		
7-10	MT-63/3D8.5S/L		
9-13	MT-63/3D11S/L		
12-18	MT-63/3D15S/L		
16-22	MT-63/3D19S/L		
18-25	MT-63/3D21.5S/L		
24-36	MT-63/3D30S/L		
28-40	MT-63/3D34S/L		
34-50	MT-63/3D42S/L		
45-65	MT-63/3D55S/L		

MT-95



MT-95/ S



MT-95/ L

Setting range (A)	Ordering type	Contactor	Separate mounting unit
	Differential		
7-10	MT-95/3D8.5S/L	MC-75a MC-85a MC-100a	UZ-95S/L
9-13	MT-95/3D11S/L		
12-18	MT-95/3DK15S/L		
16-22	MT-95/3D19S/L		
18-25	MT-95/3D21.5S/L		
24-36	MT-95/3D30S/L		
28-40	MT-95/3D34S/L		
34-50	MT-95/3D42S/L		
45-65	MT-95/3D55S/L		
54-75	MT-95/3D65S/L		
63-85	MT-95/3D74S/L		
70-95	MT-95/3D83S/L		
80-100	MT-95/3D90S/L		

MT-150



MT-150/ S

Setting range (A)	Ordering type	Contactor	Separate mounting unit
	Differential		
34-50	MT-150/3D42S/L	MC-130a MC-150a	UZ-150S/L
45-65	MT-150/3D55S/L		
54-75	MT-150/3D65S/L		
63-85	MT-150/3D74S/L		
80-105	MT-150/3D93S/L		
95-130	MT-150/3D113S/L		
110-150	MT-150/3D130S/L		

Trip class 20

Terminal type: Screw

Degree of protection: IP20

MT-225



MT-225/3D

Setting range (A)	Ordering type	Contactor	Remarks
	Differential		
65~100	MT-225/3D80	MC-185a MC-225a	-
85~125	MT-225/3D107		
100~160	MT-225/3D130		
120~185	MT-225/3D153		
160~240	MT-225/3D200		

MT-400



MT-400/3D

Setting range (A)	Ordering type	Contactor	Remarks
	Differential		
85~125	MT-400/3D107	MC-265a MC-330a MC-400a	-
100~160	MT-400/3D130		
120~185	MT-400/3D153		
160~240	MT-400/3D200		
200~330	MT-400/3D265		
260~400	MT-400/3D350		

MT-800



MT-800/3D

Setting range (A)	Ordering type	Contactor	Remarks
	Differential		
200~330	MT-800/3D265	MC-500a MC-630a MC-800a	-
260~400	MT-800/3D350		
400~630	MT-800/3D515		
520~800	MT-800/3D660		

Overload relay trip curves

Class 10A, 18AF

- MT-12/2H
- MT-12/3H
- MT-12/3K

Cold starting

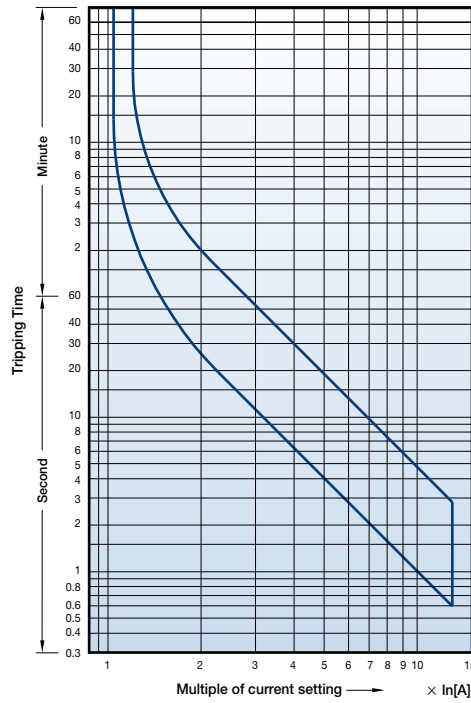

Hot starting

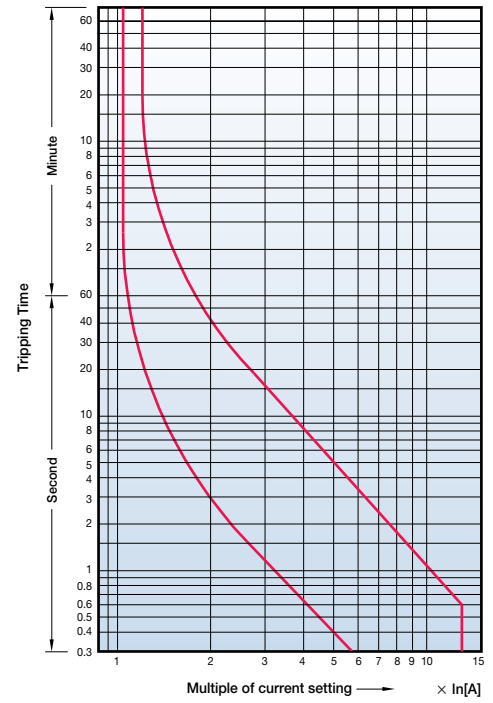

Class 20, 18AF

- MT-12/3D

Cold starting

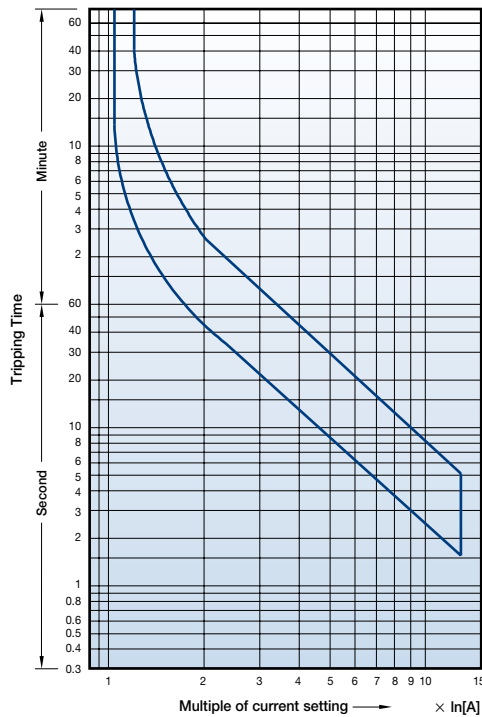

Hot starting

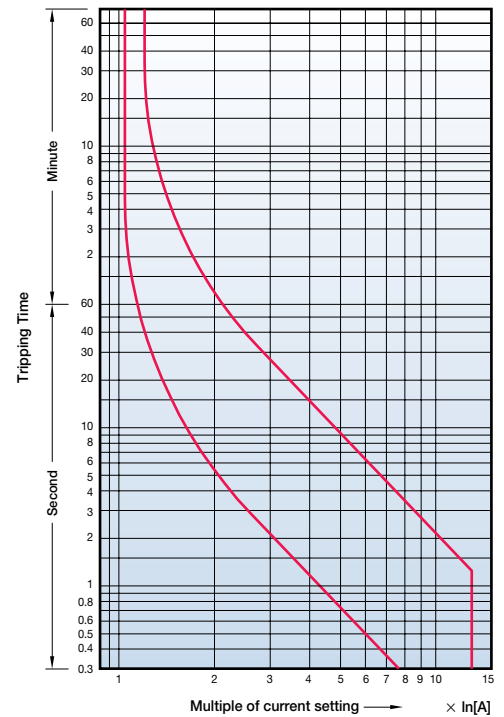

Class 10A, 40AF

- MT-32/2H
- MT-32/3H
- MT-32/3K

Cold starting

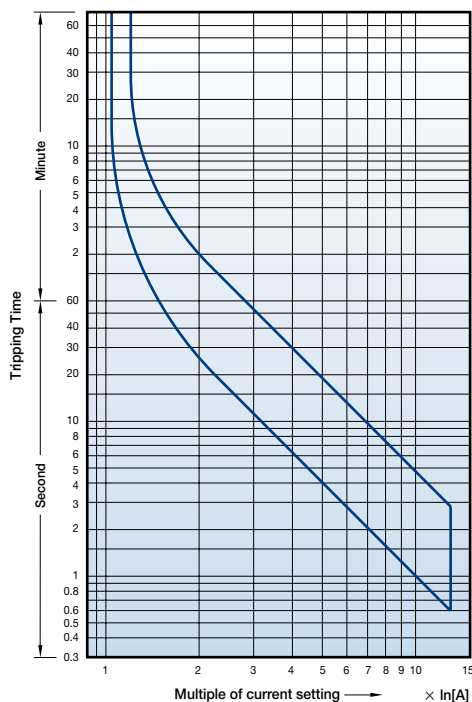

Hot starting

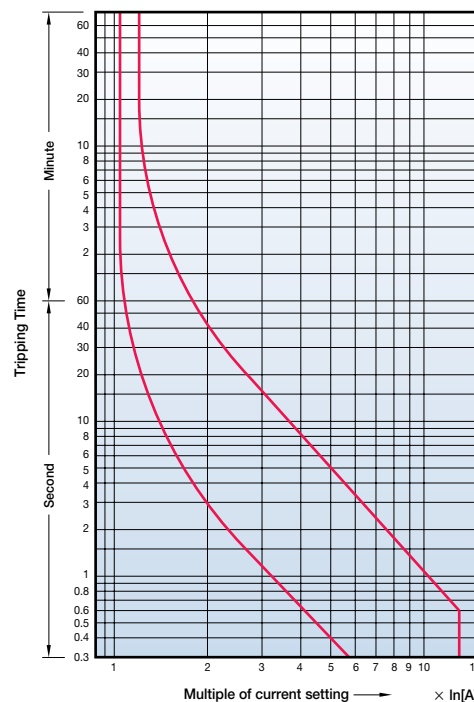

Class 20, 40AF

- MT-32/3D

Cold starting

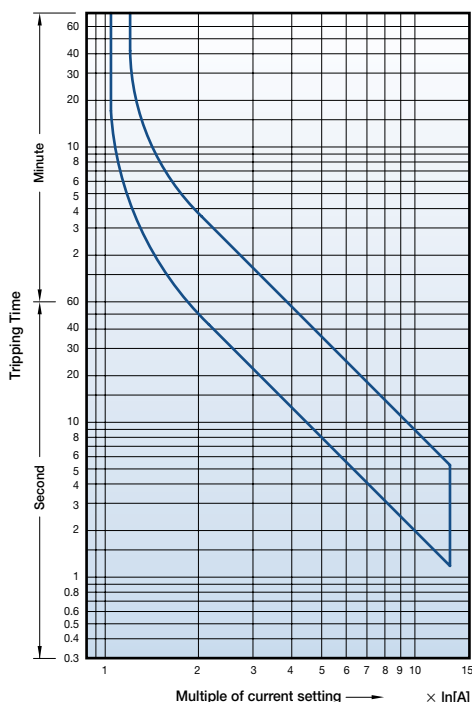

Hot starting

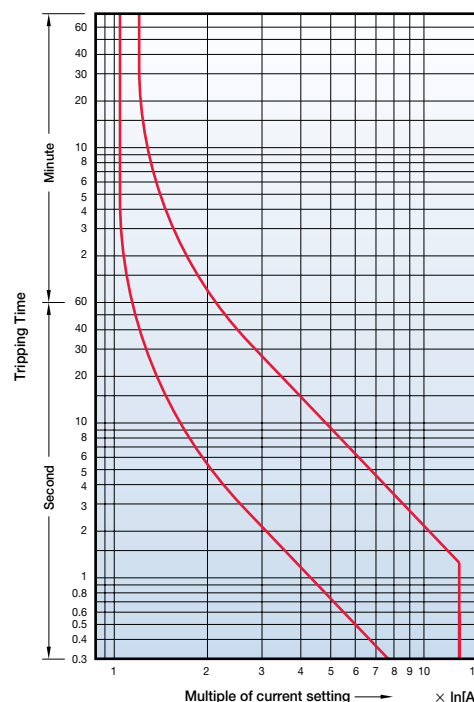

Overload relay trip curves

Class 10A, 65AF

- MT-63/2H
- MT-63/3H
- MT-63/3K

Cold starting

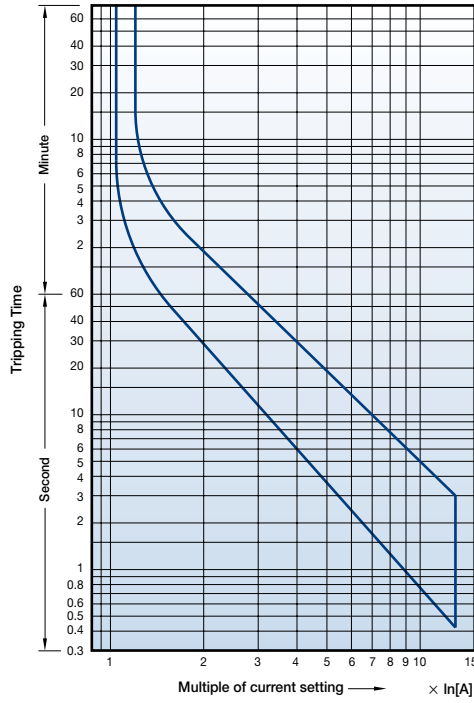

Hot starting

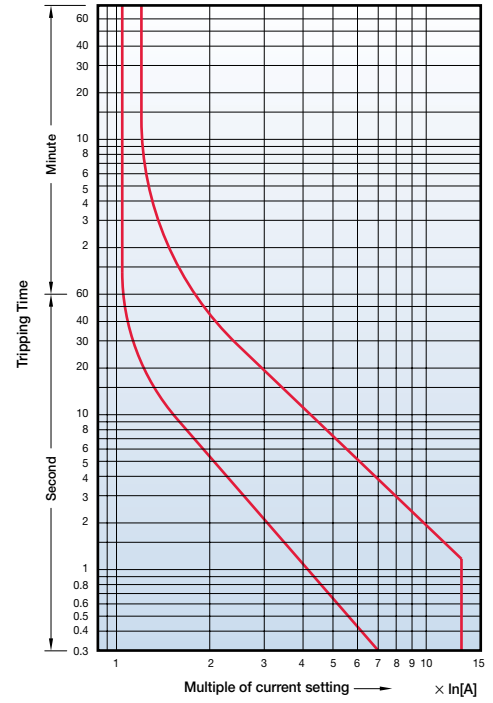

Class 20, 65AF

- MT-63/3D

Cold starting

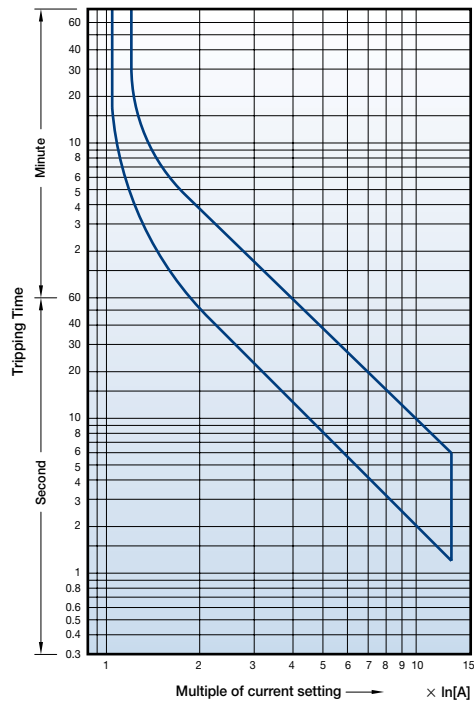

Hot starting

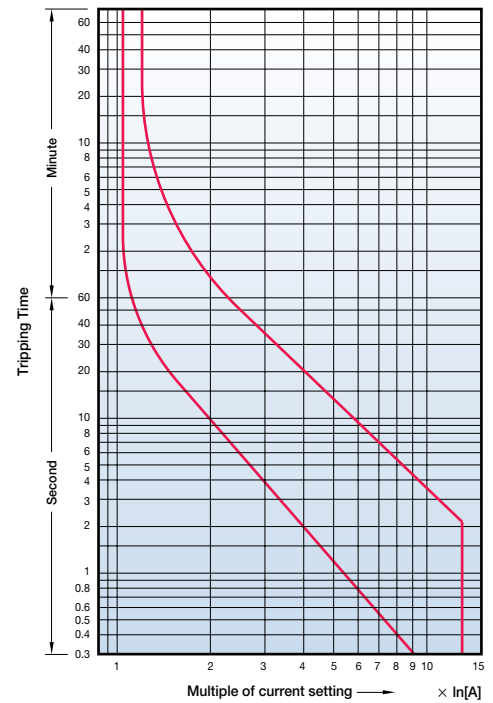

Class 10A, 100AF

- MT-95/2H
- MT-95/3H
- MT-95/3K

Cold starting

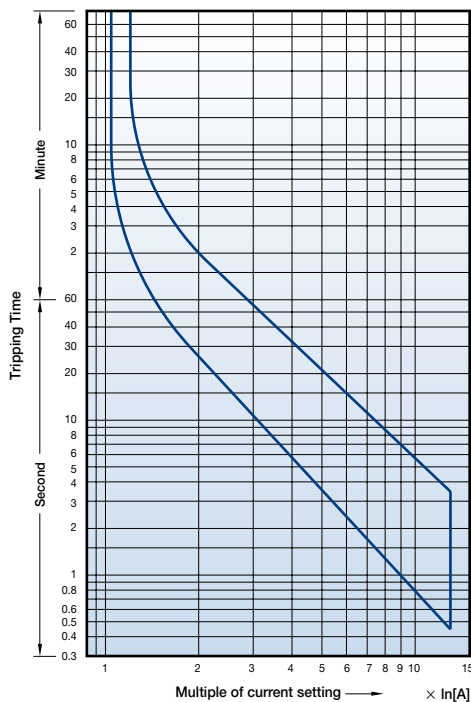

Hot starting

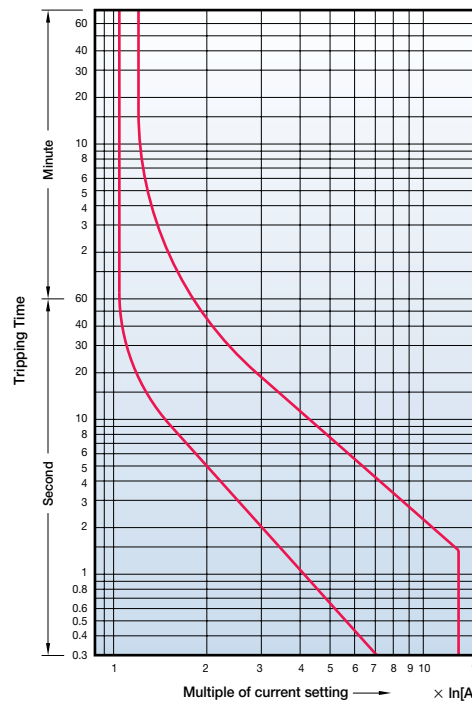

Class 20, 100AF

- MT-95/3D

Cold starting

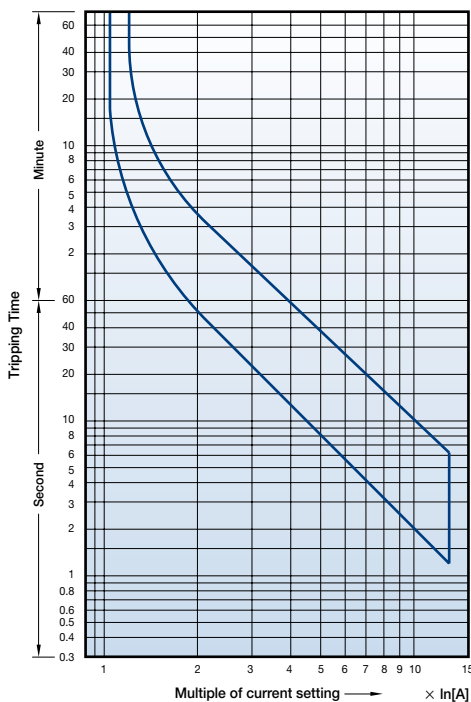

Hot starting

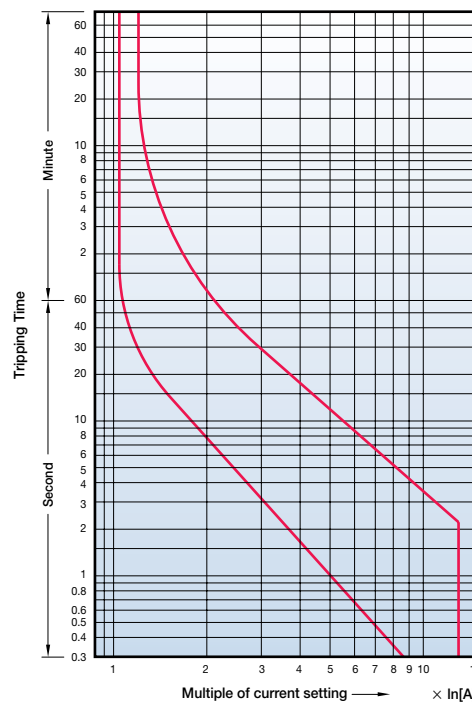

Overload relay trip curves

Class 10A, 150AF

- MT-150/2H
- MT-150/3H
- MT-150/3K

Cold starting

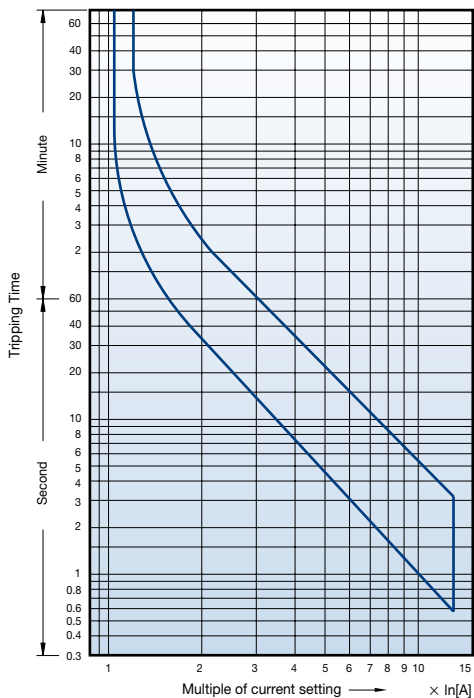

Hot starting

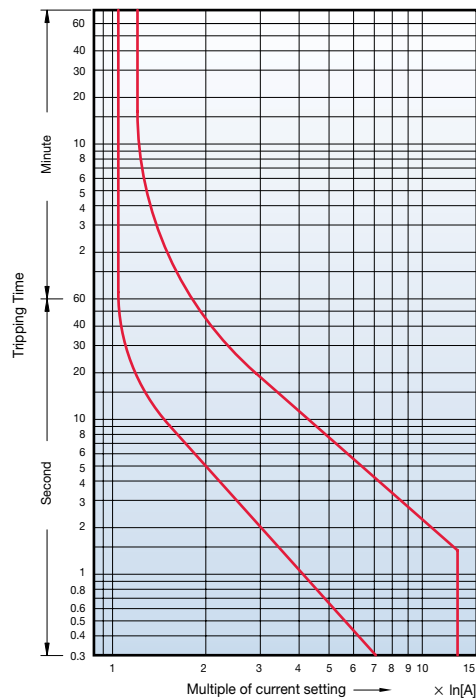

Class 20, 150AF

- MT-150/3D

Cold starting

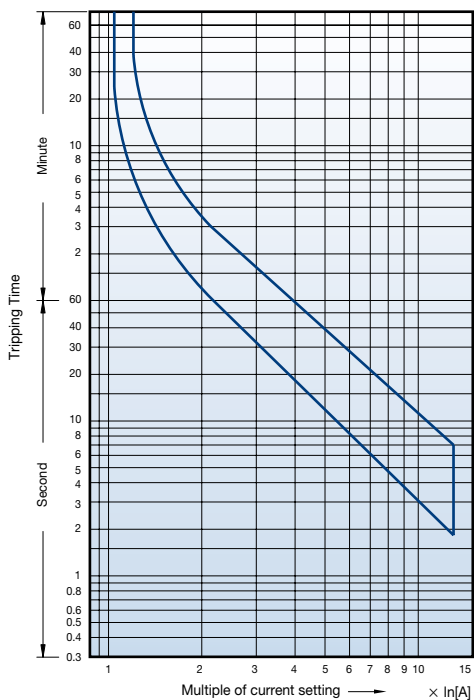

Hot starting

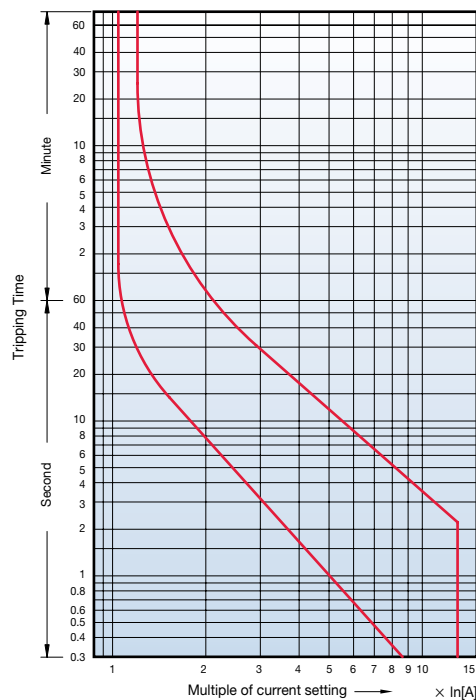

Class 10A, 225AF

- MT-225/2H
- MT-225/3H
- MT-225/3K

Cold starting

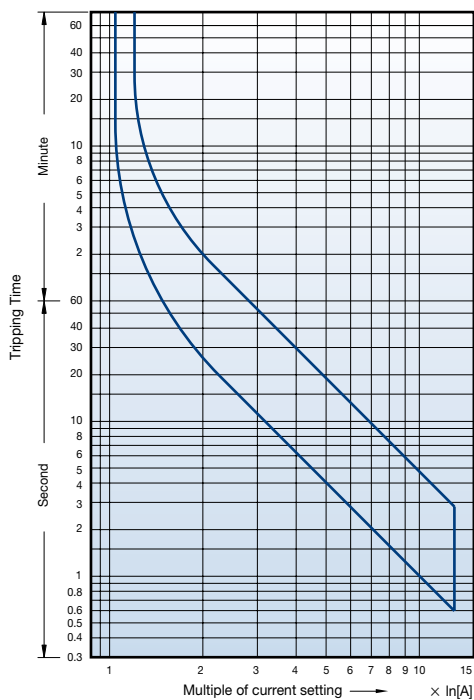

Hot starting

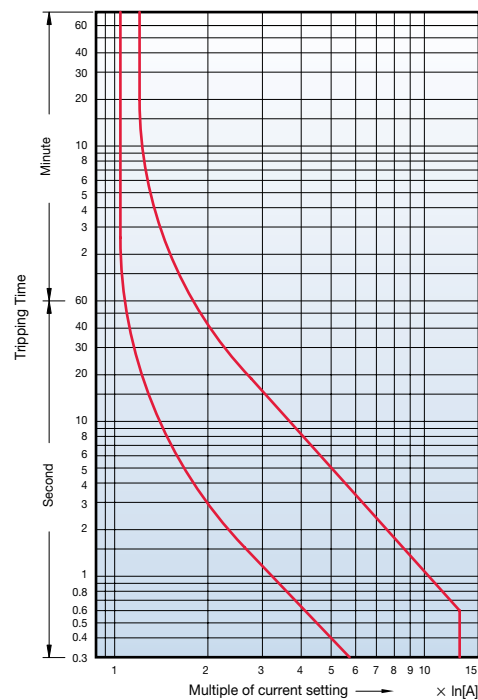

Class 20, 225AF

- MT-225/3D

Cold starting

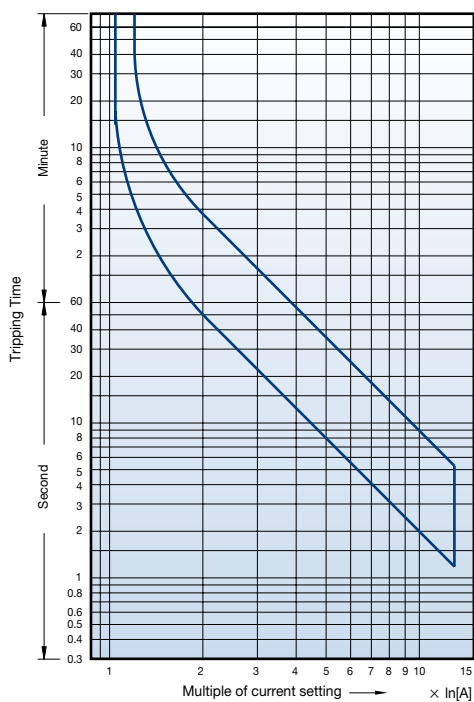

Hot starting

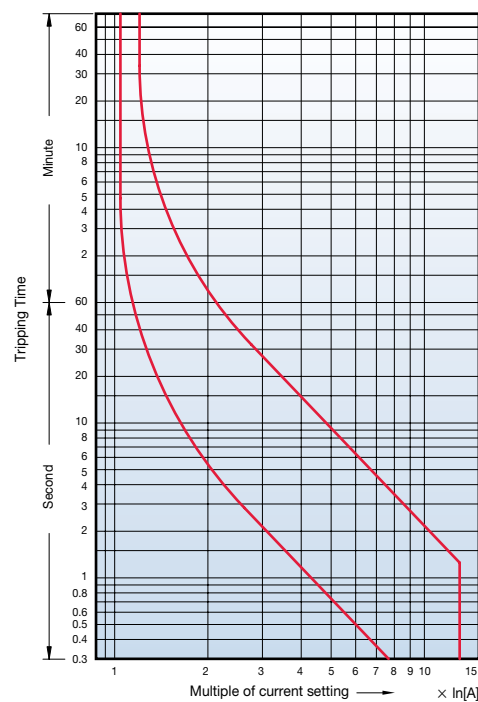

Overload relay trip curves

Class 10A, 400AF

- MT-400/2H
- MT-400/3H
- MT-400/3K

Cold starting

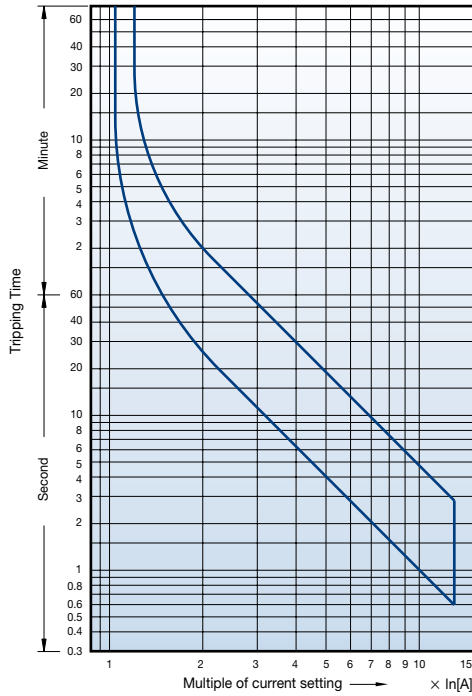

Hot starting

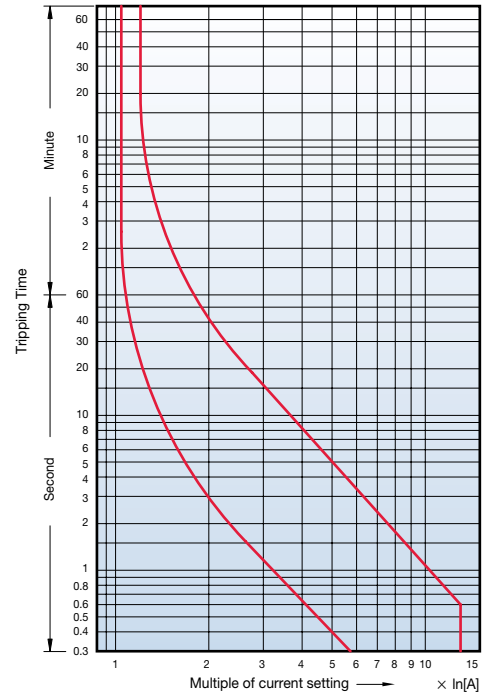

Class 20, 400AF

- MT-400/3D

Cold starting

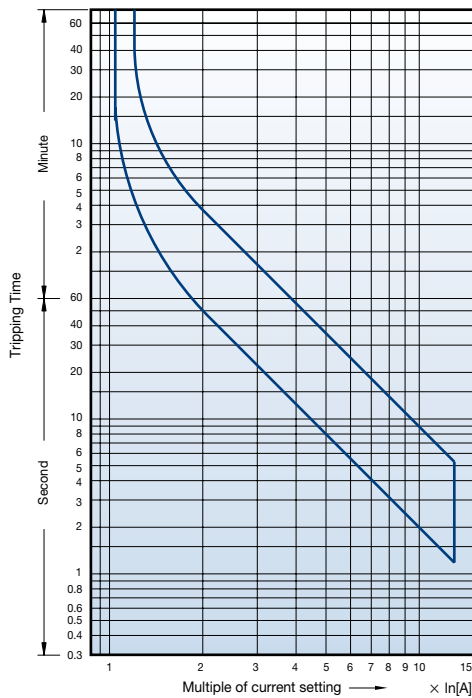

Hot starting

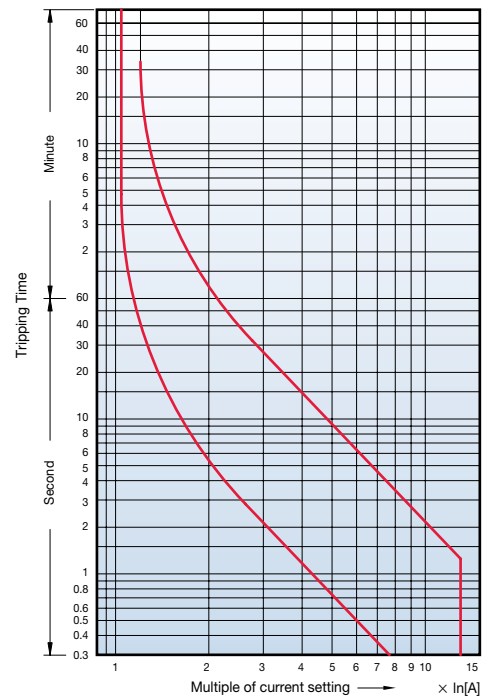

Class 10A, 800AF

- MT-800/2H
- MT-800/3H
- MT-800/3K

Cold starting

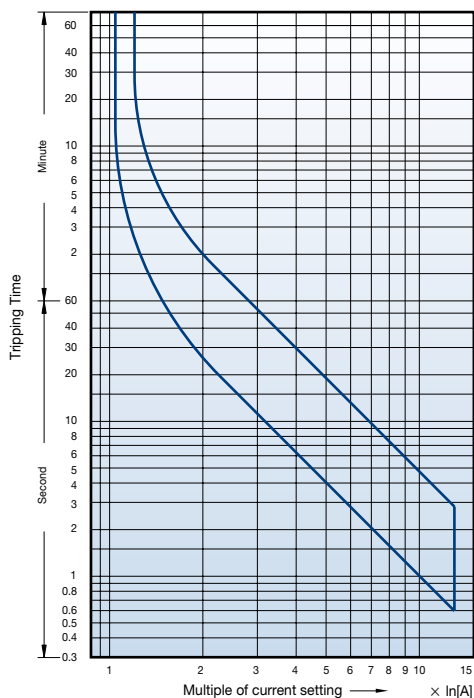

Hot starting

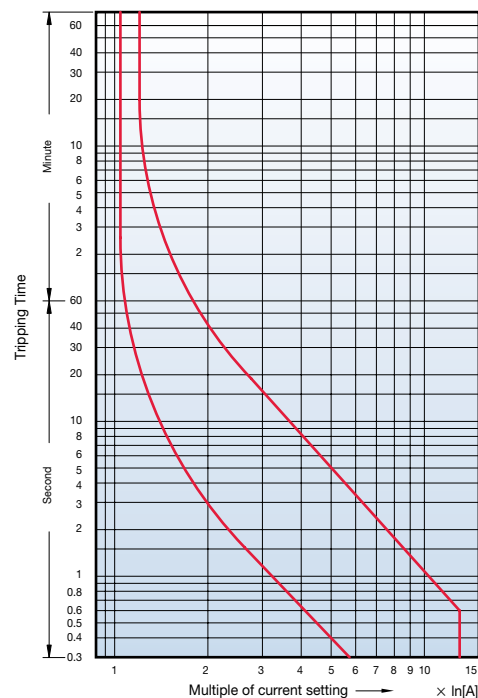

Class 20, 800AF

- MT-800/3D

Cold starting

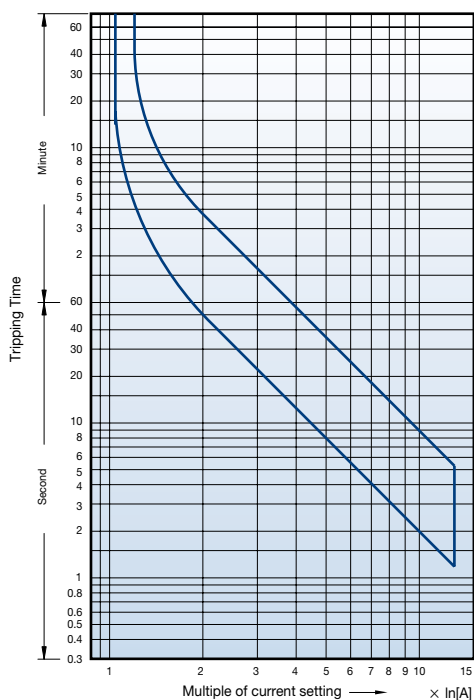

Hot starting

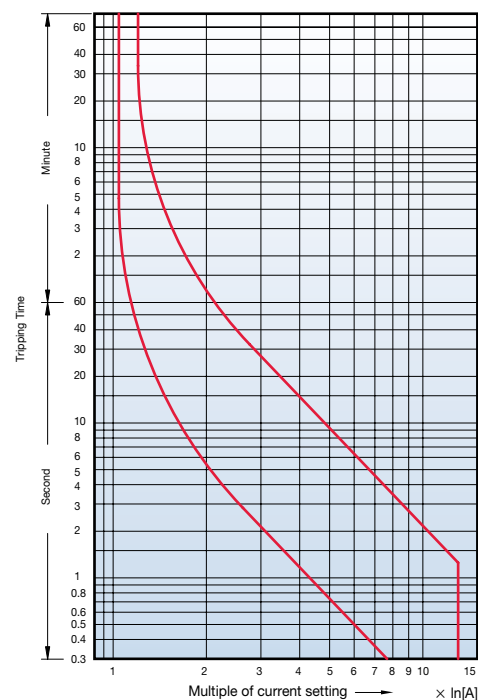

Type 2 Coordination (380/415V)

415V

HI type MMS, Susol MCCB

kW	Rated Operational Power			Circuit Breaker		Contactor	Thermal Overload Relays		Short Circuit Breaking Capacity	
	Current [A]			Type	Rating [A]	Type	Type	Setting Range [A]	I _r [kA]	I _q [kA]
	380V	400V	415V							
0.06	0.21	0.20	0.19	MMS-32HI	0.25	MC-6a	MT-12	0.16~0.25	1	50
0.09	0.32	0.30	0.29	MMS-32HI	0.4	MC-6a	MT-12	0.25~0.4	1	50
0.12	0.46	0.44	0.42	MMS-32HI	0.63	MC-6a	MT-12	0.4~0.63	1	50
0.18	0.63	0.60	0.58	MMS-32HI	0.63	MC-6a	MT-12	0.4~0.63	1	50
0.25	0.89	0.85	0.82	MMS-32HI	1	MC-6a	MT-12	0.63~1	1	50
0.37	1.16	1.10	1.06	MMS-32HI	1.6	MC-12a,12b	MT-12	1~1.6	1	50
0.55	1.6	1.5	1.4	MMS-32HI	1.6	MC-12a,12b	MT-12	1~1.6	1	50
0.75	2.0	1.9	1.8	MMS-32HI	2.5	MC-12a,12b	MT-12	1.6~2.5	1	50
1.1	2.8	2.7	2.6	MMS-32HI	4	MC-22b	MT-32	2.5~4	1	50
1.5	3.8	3.6	3.5	MMS-32HI	4	MC-22b	MT-32	2.5~4	1	50
2.2	5.2	4.9	4.7	MMS-32HI	6	MC-22b	MT-32	4~6	1	50
3.0	6.8	6.5	6.3	MMS-32HI	8	MC-40a	MT-32	5~8	1	50
4.0	8.9	8.5	8.2	MMS-32HI	10	MC-40a	MT-32	6~9	1	50
5.5	12.1	11.5	11.1	MMS-32HI	13	MC-40a	MT-32	9~13	3	50
7.5	16.3	15.5	14.9	MMS-32HI	17	MC-40a	MT-32	12~18	3	50
11.0	23.2	22.0	21.2	TD100	25	MC-50a	MT-63	18~25	3	70
15.0	31	29	28	TD100	32	MC-50a	MT-63	24~36	3	70
18.5	37	35	34	TD100	40	MC-50a	MT-63	28~40	3	70
22	43	41	40	TD100	50	MC-50a	MT-63	34~50	3	70
30	58	55	53	TD100	63	MC-65a	MT-63	45~65	3	70
37	69	66	64	TD100	80	MC-75a	MT-95	54~75	5	70
45	84	80	77	TD100	100	MC-85a	MT-95	63~85	5	70
55	-	-	93	TD100	100	MC-100a	MT-95	70~95	5	70

415V

H type MMS, Susol MCCB

kW	Rated Operational Power			Circuit Breaker		Contactor	Thermal Overload Relays		Short Circuit Breaking Capacity	
	Current [A]			Type	Rating [A]	Type	Type	Setting Range [A]	Ir [kA]	Iq [kA]
	380V	400V	415V							
0.06	0.21	0.20	0.19	MMS-32H	0.25	MC-6a	MT-12	0.16~0.25	1	50
0.09	0.32	0.30	0.29	MMS-32H	0.4	MC-6a	MT-12	0.25~0.4	1	50
0.12	0.46	0.44	0.42	MMS-32H	0.63	MC-6a	MT-12	0.4~0.63	1	50
0.18	0.63	0.60	0.58	MMS-32H	0.63	MC-6a	MT-12	0.4~0.63	1	50
0.25	0.89	0.85	0.82	MMS-32H	1	MC-6a	MT-12	0.63~1	1	50
0.37	1.16	1.10	1.06	MMS-32H	1.6	MC-12a,12b	MT-12	1~1.6	1	50
0.55	1.6	1.5	1.4	MMS-32H	1.6	MC-12a,12b	MT-12	1~1.6	1	50
0.75	2.0	1.9	1.8	MMS-32H	2.5	MC-12a,12b	MT-12	1.6~2.5	1	50
1.1	2.8	2.7	2.6	MMS-32H	4	MC-22b	MT-32	2.5~4	1	50
1.5	3.8	3.6	3.5	MMS-32H	4	MC-22b	MT-32	2.5~4	1	50
2.2	5.2	4.9	4.7	MMS-32H	6	MC-22b	MT-32	4~6	1	50
3.0	6.8	6.5	6.3	MMS-32H	8	MC-40a	MT-32	5~8	1	50
4.0	8.9	8.5	8.2	MMS-32H	10	MC-40a	MT-32	6~9	1	50
5.5	12.1	11.5	11.1	MMS-32H	13	MC-40a	MT-32	9~13	3	50
7.5	16.3	15.5	14.9	MMS-32H	17	MC-40a	MT-32	12~18	3	50
11.0	23.2	22.0	21.2	TD100	25	MC-50a	MT-63	18~25	3	70
15.0	31	29	28	TD100	32	MC-50a	MT-63	24~36	3	70
18.5	37	35	34	TD100	40	MC-50a	MT-63	28~40	3	70
22	43	41	40	TD100	50	MC-50a	MT-63	34~50	3	70
30	58	55	53	TD100	63	MC-65a	MT-63	45~65	3	70
37	69	66	64	TD100	80	MC-75a	MT-95	54~75	5	70
45	84	80	77	TD100	100	MC-85a	MT-95	63~85	5	70
55	-	-	93	TD100	100	MC-100a	MT-95	70~95	5	70

Type 2 Coordination (380/415V)

415V

Susol MCCB

kW	Rated Operational Power			Circuit Breaker		Contactor	Thermal Overload Relays		Short Circuit Breaking Capacity	
	Current [A]			Type	Rating [A]	Type	Type	Setting Range [A]	Ir [kA]	Iq [kA]
	380V	400V	415V							
0.06	0.21	0.20	0.19	TS100 (1)	1.6	MC-6a	MT-12	0.16~0.25	1	50
0.09	0.32	0.30	0.29	TS100 (1)	1.6	MC-6a	MT-12	0.25~0.4	1	50
0.12	0.46	0.44	0.42	TS100 (1)	1.6	MC-6a	MT-12	0.4~0.63	1	50
0.18	0.63	0.60	0.58	TS100 (1)	1.6	MC-6a	MT-12	0.4~0.63	1	50
0.25	0.89	0.85	0.82	TS100 (1)	1.6	MC-6a	MT-12	0.63~1	1	50
0.37	1.16	1.10	1.06	TS100 (1)	1.6	MC-12a,12b	MT-12	1~1.6	1	50
0.55	1.6	1.5	1.4	TS100 (1)	1.6	MC-12a,12b	MT-12	1~1.6	1	50
0.75	2.0	1.9	1.8	TS100 (1)	1.6	MC-12a,12b	MT-12	1.6~2.5	1	50
1.1	2.8	2.7	2.6	TS100 (1)	3.2	MC-22b	MT-32	2.5~4	1	50
1.5	3.8	3.6	3.5	TS100 (1)	3.2	MC-22b	MT-32	2.5~4	1	50
2.2	5.2	4.9	4.7	TS100 (1)	3.2	MC-22b	MT-32	4~6	1	50
3.0	6.8	6.5	6.3	TS100 (1)	6.3	MC-40a	MT-32	5~8	1	50
4.0	8.9	8.5	8.2	TS100 (1)	6.3	MC-40a	MT-32	6~9	1	50
5.5	12.1	11.5	11.1	TS100 (1)	12	MC-40a	MT-32	9~13	3	50
7.5	16.3	15.5	14.9	TS100 (1)	12	MC-40a	MT-32	12~18	3	50
11.0	23.2	22.0	21.2	TD100	25	MC-50a	MT-63	18~25	3	70
15.0	31	29	28	TD100	32	MC-50a	MT-63	24~36	3	70
18.5	37	35	34	TD100	40	MC-50a	MT-63	28~40	3	70
22	43	41	40	TD100	50	MC-50a	MT-63	34~50	3	70
30	58	55	53	TD100	63	MC-65a	MT-63	45~65	3	70
37	69	66	64	TD100	80	MC-75a	MT-95	54~75	5	70
45	84	80	77	TD100	100	MC-85a	MT-95	63~85	5	70
55	-	-	93	TD100	100	MC-100a	MT-95	70~95	5	70

Note) (1) This marks admit for motor protection MTU trip unit only.

Type 2 Coordination (440V)

440V

Susol MCCB N-type

Rated Operational Power		Circuit Breaker		Contactor	Thermal Overload Relays		Short Circuit Breaking Capacity	
kW	Current [A]	Type	Rating [A]	Type	Type	Setting Range [A]	I _r [kA]	I _q [kA]
	440V							
1.1	2.37	TD100N	16	MC-12b	MT-32	2.5~4	1	50
1.5	3.06	TD100N	16	MC-18b	MT-32	2.5~4	1	50
2.2	4.42	TD100N	16	MC-22b	MT-32	4~6	1	50
3	5.77	TD100N	16	MC-22b	MT-32	5~8	1	50
4	7.90	TD100N	16	MC-32a	MT-32	6~9	1	50
5.5	10.40	TD100N	16	MC-32a	MT-32	9~13	3	50
7.5	13.70	TD100N	20	MC-32a	MT-32	12~18	3	50
11	20.10	TD100N	32	MC-40a	MT-32	18~25	3	50
15	26.50	TD100N	40	MC-40a	MT-32	22~32	3	50
18.5	32.80	TS100N	40	MC-50a	MT-63	28~40	3	50
22	39.00	TS100N	50	MC-50a	MT-63	34~50	3	50
30	51.50	TS100N	63	MC-65a	MT-63	45~65	3	50
37	64.00	TS100N	80	MC-75a	MT-95	54~75	5	50
45	76.00	TS100N	100	MC-85a	MT-95	63~85	5	50
55	90.00	TS100N	100	MC-100a	MT-95	70~95	5	50
59	97.00	TS160N	100	MC-130a	MT-150	80~105	5	50
75	125	TS160N	160	MC-150a	MT-150	110~150	10	50
90	146	TS160N	160	MC-185a	MT-225	120~185	10	50
110	178	TS250N	200	MC-185a	MT-225	160~240	10	50
132	215	TS250N	250	MC-225a	MT-225	160~240	10	65
160	256	TS400N	300	MC-400a	MT-400	200~330	18	65
200	330	TS400N	400	MC-400a	MT-400	260~400	18	65
220	353	TS400N	400	MC-400a	MT-400	260~400	18	65
250	401	TS630N	500	MC-630a	MT-800	260~400	18	65
300	481	TS630N	500	MC-630a	MT-800	400~630	18	65

Type 2 Coordination (440V)

440V

Susol MCCB H-type

Rated Operational Power		Circuit Breaker		Contactor	Thermal Overload Relays		Short Circuit Breaking Capacity	
kW	Current [A]	Type	Rating [A]	Type	Type	Setting Range [A]	Ir [kA]	Iq [kA]
	440V							
1.1	2.37		TD100H	16	MC-12b	MT-32	2.5~4	1 50
1.5	3.06		TD100H	16	MC-18b	MT-32	2.5~4	1 50
2.2	4.42		TD100H	16	MC-22b	MT-32	4~6	1 50
3	5.77		TD100H	16	MC-22b	MT-32	5~8	1 50
4	7.90		TD100H	16	MC-32a	MT-32	6~9	1 50
5.5	10.40		TD100H	16	MC-32a	MT-32	9~13	3 50
7.5	13.70		TD100H	20	MC-32a	MT-32	12~18	3 70
11	20.10		TD100H	32	MC-40a	MT-32	18~25	3 70
15	26.50		TD100H	40	MC-40a	MT-32	22~32	3 70
18.5	32.80		TS100H	40	MC-50a	MT-63	28~40	3 70
22	39.00		TS100H	50	MC-50a	MT-63	34~50	3 70
30	51.50		TS100H	63	MC-65a	MT-63	45~65	3 70
37	64.00		TS100H	80	MC-75a	MT-95	54~75	5 70
45	76.00		TS100H	100	MC-85a	MT-95	63~85	5 70
55	90.00		TS100H	100	MC-100a	MT-95	70~95	5 70
59	97.00		TS160H	100	MC-130a	MT-150	80~105	5 70
75	125		TS160H	160	MC-150a	MT-150	110~150	10 70
90	146		TS160H	160	MC-185a	MT-225	120~185	10 70
110	178		TS250H	200	MC-185a	MT-225	160~240	10 70
132	215		TS250H	250	MC-225a	MT-225	160~240	10 70
160	256		TS400H	300	MC-400a	MT-400	200~330	18 85
200	330		TS400H	400	MC-400a	MT-400	260~400	18 85
220	353		TS400H	400	MC-400a	MT-400	260~400	18 85
250	401		TS630H	500	MC-630a	MT-800	260~400	18 85
300	481		TS630H	500	MC-630a	MT-800	400~630	18 100

440V

Susol MCCB L-type

Rated Operational Power		Circuit Breaker		Contactor	Thermal Overload Relays		Short Circuit Breaking Capacity	
kW	Current [A]	Type	Rating [A]	Type	Type	Setting Range [A]	Ir [kA]	Iq [kA]
	440V							
1.1	2.37	TD100L	16	MC-12b	MT-32	2.5~4	1	50
1.5	3.06	TD100L	16	MC-18b	MT-32	2.5~4	1	50
2.2	4.42	TD100L	16	MC-22b	MT-32	4~6	1	50
3	5.77	TD100L	16	MC-22b	MT-32	5~8	1	50
4	7.90	TD100L	16	MC-32a	MT-32	6~9	1	50
5.5	10.40	TD100L	16	MC-32a	MT-32	9~13	3	50
7.5	13.70	TD100L	20	MC-32a	MT-32	12~18	3	100
11	20.10	TD100L	32	MC-40a	MT-32	18~25	3	100
15	26.50	TD100L	40	MC-40a	MT-32	22~32	3	100
18.5	32.80	TS100L	40	MC-50a	MT-63	28~40	3	130
22	39.00	TS100L	50	MC-50a	MT-63	34~50	3	130
30	51.50	TS100L	63	MC-65a	MT-63	45~65	3	130
37	64.00	TS100L	80	MC-75a	MT-95	54~75	5	130
45	76.00	TS100L	100	MC-85a	MT-95	63~85	5	130
55	90.00	TS100L	100	MC-100a	MT-95	70~95	5	130
59	97.00	TS160L	100	MC-130a	MT-150	80~105	5	130
75	125	TS160L	160	MC-150a	MT-150	110~150	10	130
90	146	TS160L	160	MC-185a	MT-225	120~185	10	130
110	178	TS250L	200	MC-185a	MT-225	160~240	10	130
132	215	TS250L	250	MC-225a	MT-225	160~240	10	130
160	256	TS400L	300	MC-400a	MT-400	200~330	18	130
200	330	TS400L	400	MC-400a	MT-400	260~400	18	130
220	353	TS400L	400	MC-400a	MT-400	260~400	18	130
250	401	TS630L	500	MC-630a	MT-800	260~400	18	130
300	481	TS630L	500	MC-630a	MT-800	400~630	18	130

Type 2 Coordination (440V)

440V

Metasol MCCB N-type

Rated Operational Power		Circuit Breaker		Contactor	Thermal Overload Relays		Short Circuit Breaking Capacity	
kW	Current [A]	Type	Rating [A]	Type	Type	Setting Range [A]	Ir [kA]	Iq [kA]
	440V							
1.1	2.37	ABN53c	15	MC-12b	MT-32	2.5~4	1	14
1.5	3.06	ABN53c	15	MC-18b	MT-32	2.5~4	1	14
2.2	4.42	ABN53c	15	MC-22b	MT-32	4~6	1	14
3.0	5.77	ABN53c	15	MC-22b	MT-32	5~8	1	14
4.0	7.90	ABN53c	15	MC-32a	MT-32	6~9	1	14
5.5	10.40	ABN53c	15	MC-32a	MT-32	9~13	3	14
7.5	13.70	ABN53c	20	MC-32a	MT-32	12~18	3	14
11.0	20.10	ABN103c	30	MC-40a	MT-32	18~25	3	18
15.0	26.50	ABN103c	40	MC-40a	MT-32	22~32	3	18
18.5	32.80	ABN103c	40	MC-50a	MT-63	28~40	3	18
22.0	39.00	ABN103c	50	MC-50a	MT-63	34~50	3	18
30.0	51.50	ABN103c	75	MC-65a	MT-63	45~65	3	18
37.0	64.00	ABN103c	75	MC-75a	MT-95	54~75	5	18
45.0	76.00	ABN103c	100	MC-85a	MT-95	63~85	5	18
55.0	90.00	ABN103c	100	MC-100a	MT-95	70~95	5	18
59.0	97.00	ABN103c	100	MC-130a	MT-150	80~105	5	18
75.0	125	ABN203c	150	MC-150a	MT-150	110~150	10	26
90.0	146	ABN203c	200	MC-185a	MT-225	120~185	10	26
110.0	178	ABN203c	200	MC-185a	MT-225	160~240	10	26
132.0	215	ABN203c	250	MC-225a	MT-225	160~240	10	26
160.0	256	ABN403c	300	MC-400a	MT-400	200~330	18	37
200.0	330	ABN403c	400	MC-400a	MT-400	260~400	18	37
220.0	353	ABN403c	400	MC-400a	MT-400	260~400	18	37
250.0	401	ABN803c	500	MC-630a	MT-800	260~400	18	37
300.0	481	ABN803c	500	MC-630a	MT-800	400~630	18	37

Type C Coordination (240V)

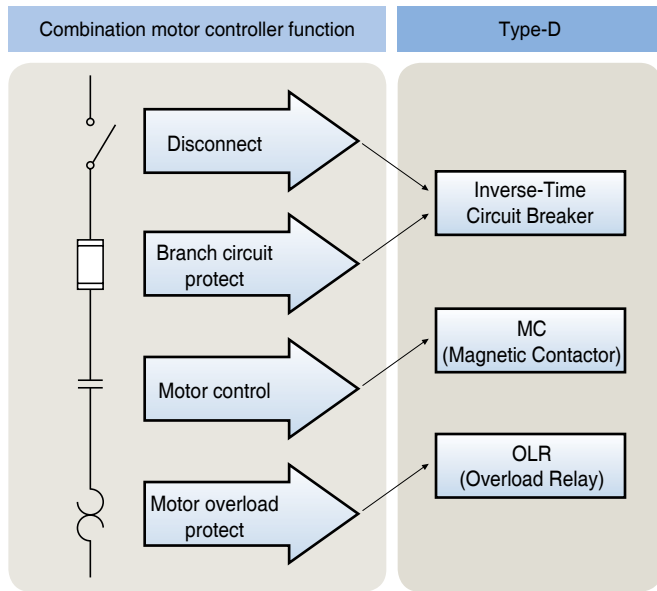

240V

Metasol MCCB C-type

CB	MC	OLR	kA@240V	Maximum HP	Maximum NEC FLC [A]
UTE100E	MC-6a	MT-12 0.1~10A	50	3	9.6
UTE100N			65	3	
UTE100E	MC-9a	MT-12 0.1~10A	50	3	
UTE100N			65	3	
UTE100E	MC-12a	MT-12 0.1~18A	50	5	15.2
UTE100N			65	5	
UTE100E	MC-18a	MT-12 0.1~18A	50	7.5	22
UTE100N			65	7.5	
UTS150N			65	7.5	
UTS150L			100	7.5	
UTE100E	MC-9b	MT-32 0.1~10A	50	3	9.6
UTE100N			65	3	
UTE100E	MC-12b	MT-32 0.1~18A	50	5	15.2
UTE100N			65	5	
UTE100E	MC-18b	MT-32 0.1~25A	50	7.5	22
UTE100N			65	7.5	
UTS150N			65	7.5	
UTS150L			100	7.5	
UTE100E	MC-22b	MT-32 0.1~32A	50	10	28
UTE100N			65	10	
UTS150N			65	10	
UTS150L			100	10	
UTE100E	MC-32a	MT-32 0.1~32A	50	10	28
UTE100N			65	10	
UTS150N			65	10	
UTS150L			100	10	
UTE100E	MC-40a	MT-32 0.1~40A	50	15	42
UTE100N			65	15	
UTS150N			65	15	
UTS150L			100	15	

Type C Coordination (240V)

240V

Metasol MCCB C-type

CB	MC	OLR	kA@240V	Maximum HP	Maximum NEC FLC [A]	
UTE100E	MC-6a	MT-12 0.1~10A	50	3	9.6	
UTE100N			65	3		
UTE100E	MC-9a	MT-12 0.1~10A	50	3		
UTE100N			65	3		
UTE100E	MC-12a	MT-12 0.1~18A	50	5		15.2
UTE100N			65	5		
UTE100E	MC-18a	MT-12 0.1~18A	50	7.5	22	
UTE100N			65	7.5		
UTS150N			65	7.5		
UTS150L			100	7.5		
UTE100E	MC-9b	MT-32 0.1~10A	50	3	9.6	
UTE100N			65	3		
UTE100E	MC-12b	MT-32 0.1~18A	50	5	15.2	
UTE100N			65	5		
UTE100E	MC-18b	MT-32 0.1~25A	50	7.5	22	
UTE100N			65	7.5		
UTS150N			65	7.5		
UTS150L			100	7.5		
UTE100E	MC-22b	MT-32 0.1~32A	50	10	28	
UTE100N			65	10		
UTS150N			65	10		
UTS150L			100	10		
UTE100E	MC-32a	MT-32 0.1~32A	50	10	28	
UTE100N			65	10		
UTS150N			65	10		
UTS150L			100	10		
UTE100E	MC-40a	MT-32 0.1~40A	50	15	42	
UTE100N			65	15		
UTS150N			65	15		
UTS150L			100	15		
UTE100E	MC-50a	MT-63 4~65A	50	25	65	
UTE100N			65	25		
UTS150N			65	25		
UTS150L			100	25		
UTE100E	MC-65a	MT-63 4~65A	50	30	80	
UTE100N			65	30		
UTS150N			65	30		
UTS150L			100	30		
UTS150N	MC-75a	MT-95 7~95A	65	30	80	
UTS150L			100	30		
UTS150N	MC-85a	MT-95 7~100A	65	40	104	
UTS150L			100	40		
UTS150N	MC-100a	MT-95 7~100A	65	40	104	
UTS150L			100	40		
UTS150N	MC-130a	MT-150 34~130A	65	40	104	
UTS150L			100	40		
UTS150N	MC-150a	MT-150 34~130A	65	50	130	
UTS150L			100	50		
UTS250N			65	50		
UTS250L			100	50		
UTS250N	MC-185a	MT-225 65~185A	65	60	154	
UTS250L			100	60		
UTS400N			65	60		
UTS400L			100	60		
UTS400N	MC-225a	MT-225 65~240A	65	75	192	
UTS400L			100	75		
UTS250N			65	75		
UTS250L	100	75	248			
UTS400N	MC-265a	MT-400 85~330A		65	100	
UTS400L			100	100		
UTS400N	MC-330a	MT-400 85~330A	65	100	248	
UTS400L			100	100		
UTS600N	MC-400a	MT-400 85~400A	65	150	360	
UTS600L			100	150		
UTS800L	MC-500a	MT-800 200~600A	100	200	480	
UTS800L	MC-630a	MT-800 200~800A	100	250	604	

Type C Coordination (480V)

480V

Metasol MCCB C-type

CB	MC	OLR	kA@480V	Maximum HP	Maximum NEC FLC [A]
UTE100E	MC-6a	MT-12 0.1~10A	480	25	7.6
UTE100N			480	35	
UTE100E			480	25	
UTE100E	MC-9a	MT-12 0.1~10A	480	35	11
UTE100N			480	25	
UTE100E	MC-12a	MT-12 0.1~13A	480	25	14
UTE100N			480	35	
UTE100E			480	25	
UTE100N			480	35	
UTS150N			480	35	
UTS150H	MC-18a	MT-12 0.1~18A	480	65	7.6
UTS150L			480	100	
UTE100E			480	25	
UTE100N	MC-9b	MT-32 0.1~10A	480	35	11
UTE100E			480	25	
UTE100E	MC-12b	MT-32 0.1~13A	480	35	14
UTE100N			480	25	
UTE100E	MC-18b	MT-32 0.1~18A	480	35	21
UTE100N			480	25	
UTS150N			480	35	
UTS150H	MC-22b	MT-32 0.1~25A	480	65	27
UTS150L			480	100	
UTE100E			480	25	
UTE100N			480	35	
UTS150N			480	35	
UTS150H	MC-32a	MT-32 0.1~32A	480	65	40
UTS150L			480	100	
UTE100E			480	25	
UTE100N	MC-40a	MT-32 0.1~40A	480	35	52
UTS150N			480	35	
UTS150H			480	65	
UTS150L			480	100	
UTE100E			480	25	
UTE100N	MC-50a	MT-63 4~65A	480	35	65
UTS150N			480	35	
UTS150H			480	65	
UTS150L			480	100	
UTE100E			480	25	
UTE100N	MC-65a	MT-63 4~65A	480	35	65
UTS150N			480	35	
UTS150H			480	65	
UTS150L			480	100	
UTS150N			480	35	
UTS150H	MC-75a	MT-95 7~75A	480	65	77
UTS150L			480	100	
UTS150N			480	35	
UTS150H	MC-85a	MT-95 7~85A	480	65	96
UTS150L			480	100	
UTS150N			480	35	
UTS150H	MC-100a	MT-95 7~100A	480	65	96
UTS150L			480	100	
UTS150N			480	35	
UTS150H	MC-130a	MT-150 34~130A	480	65	124
UTS150L			480	100	
UTS150N			480	35	
UTS150H			480	65	
UTS150L			480	100	
UTS250N	MC-150a	MT-150 34~130A	480	35	156
UTS250H			480	65	
UTS250L			480	100	
UTS250N			480	35	
UTS250H			480	65	
UTS250L	MC-185a	MT-225 65~185A	480	100	180
UTS400N			480	35	
UTS400H			480	65	
UTS400L			480	100	
UTS250N			480	35	
UTS250H	MC-225a	MT-225 65~240A	480	65	240
UTS250L			480	100	
UTS400N			480	35	
UTS400H			480	65	
UTS400L			480	100	
UTS400N	MC-265a	MT-400 85~330A	480	35	302
UTS400H			480	65	
UTS400L			480	100	
UTS400N	MC-330a	MT-400 85~330A	480	35	361
UTS400H			480	65	
UTS400L			480	100	
UTS600N	MC-400a	MT-400 85~400A	480	35	477
UTS600H			480	65	
UTS600L			480	100	
UTS800H	MC-500a	MT-800 200~600A	480	65	590
UTS800L			480	100	
UTS800H	MC-630a	MT-800 200~800A	480	65	
UTS800L			480	100	

Type C Coordination (600V)

600V

Metasol MCCB C-type

CB	MC	OLR	kA@600V	Maximum HP	Maximum NEC FLC [A]
UTE100E	MC-6a	MT-12 0.1-10A	600Y/347	14	9
UTE100N			600Y/347	18	
UTE100E	MC-9a	MT-12 0.1-10A	600Y/347	14	9
UTE100N			600Y/347	18	
UTE100E	MC-12a	MT-12 0.1-13A	600Y/347	14	11
UTE100N			600Y/347	18	
UTE100E	MC-18a	MT-12 0.1-18A	600Y/347	14	17
UTE100N			600Y/347	18	
UTS150N			600	18	
UTS150H			600	35	
UTS150L	600	50			
UTE100E	MC-9b	MT-32 0.1-10A	600Y/347	14	9
UTE100N			600Y/347	18	
UTE100E	MC-12b	MT-32 0.1-13A	600Y/347	14	11
UTE100N			600Y/347	18	
UTE100E	MC-18b	MT-32 0.1-18A	600Y/347	14	17
UTE100N			600Y/347	18	
UTE100E	MC-22b	MT-32 0.1-25A	600Y/347	14	22
UTE100N			600Y/347	18	
UTS150N			600	18	
UTS150H			600	35	
UTS150L	600	50			
UTE100E	MC-32a	MT-32 0.1-32A	600Y/347	14	27
UTE100N			600Y/347	18	
UTS150N	MC-40a	MT-32 0.1-32A	600	18	32
UTS150H			600	35	
UTS150L			600	50	
UTE100E			600Y/347	14	
UTE100N	600Y/347	18			
UTS150N	MC-50a	MT-63 4-65A	600	18	52
UTS150H			600	35	
UTS150L			600	50	
UTE100E			600Y/347	14	
UTE100N	600Y/347	18			
UTS150N	MC-65a	MT-63 4-65A	600	18	62
UTS150H			600	35	
UTS150L			600	50	
UTE100E			600Y/347	14	
UTE100N	600Y/347	18			
UTS150N	MC-75a	MT-95 7-75A	600	18	62
UTS150H			600	35	
UTS150L	MC-85a	MT-95 7-85A	600	18	77
UTS150N			600	35	
UTS150H	MC-100a	MT-95 7-85A	600	18	77
UTS150L			600	50	
UTS150N	MC-130a	MT-150 34-85A	600	18	77
UTS150H			600	35	
UTS150L	MC-150a	MT-150 34-85A	600	18	77
UTS150N			600	50	
UTS250N	MC-185a	MT-150 65-185A	600	18	125
UTS250H			600	35	
UTS250L			600	50	
UTS400N			600	18	
UTS400H	MC-225a	MT-225 65-185A	600	18	144
UTS400L			600	35	
UTS400N			600	50	
UTS400H			600	18	
UTS400L	MC-265a	MT-400 85-240A	600	18	192
UTS400N			600	35	
UTS400H	MC-330a	MT-400 85-330A	600	18	242
UTS400L			600	50	
UTS600N	MC-400a	MT-400 85-400A	600	18	289
UTS600H			600	35	
UTS600L	MC-500a	MT-800 200-400A	600	18	382
UTS800H			600	35	
UTS800L	MC-630a	MT-800 200-600A	600	18	472
UTS800N			600	50	

Type D Coordination (240V)

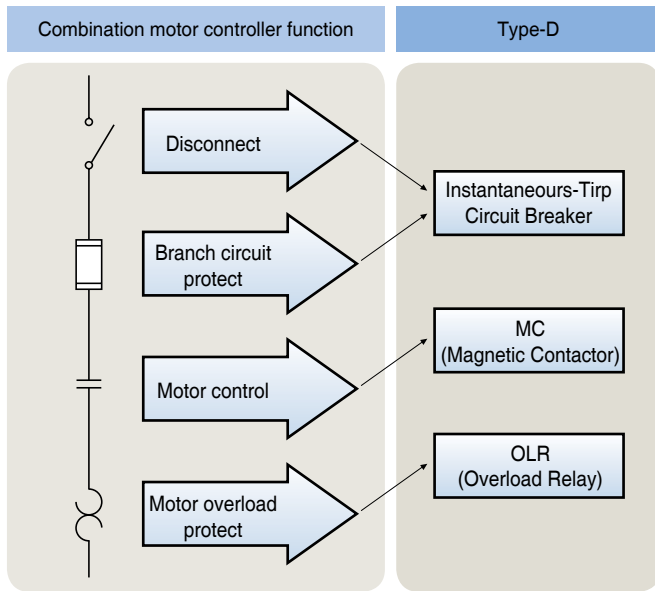

240V

Metasol MCCB D-type

CB	MC	OLR	kA@240V	Maximum HP	Maximum NEC FLC [A]
UTS150L MCP	MC-6a	MT-12 0.1~10A	100	3	9.6
UTS150L MCP	MC-9a	MT-12 0.1~10A	100	3	9.6
UTS150L MCP	MC-12a	MT-12 0.1~18A	100	5	15.2
UTS150L MCP	MC-18a	MT-12 0.1~18A	100	7.5	22
UTS150L MCP	MC-9b	MT-32 0.1~10A	100	3	9.6
UTS150L MCP	MC-12b	MT-32 0.1~18A	100	5	15.2
UTS150L MCP	MC-18b	MT-32 0.1~25A	100	7.5	22
UTS150L MCP	MC-22b	MT-32 0.1~32A	100	10	28
UTS150L MCP	MC-32a	MT-32 0.1~32A	100	10	28
UTS150L MCP	MC-40a	MT-32 0.1~40A	100	15	42
UTS150L MCP	MC-50a	MT-63 4~65A	100	25	65
UTS150L MCP	MC-65a	MT-63 4~65A	100	30	80
UTS150L MCP	MC-75a	MT-95 7~95A	100	30	80
UTS150L MCP	MC-85a	MT-95 7~100A	100	40	104
UTS150L MCP	MC-100a	MT-95 7~100A	100	40	104
UTS150L MCP	MC-130a	MT-150 34~130A	100	40	104
UTS250L MCP	MC-150a	MT-150 34~130A	100	50	130
UTS250L MCP	MC-185a	MT-225 65~160A	100	60	154
UTS400L MCP	MC-185a	MT-225 65~185A	100	60	154
UTS250L MCP	MC-225a	MT-225 65~240A	100	75	192
UTS400L MCP	MC-225a	MT-225 65~240A	100	75	192
UTS400L MCP	MC-265a	MT-400 85~330A	100	100	248
UTS400L MCP	MC-330a	MT-400 85~330A	100	100	248
UTS600L MCP	MC-400a	MT-400 85~400A	100	150	360
UTS800L MCP	MC-500a	MT-800 200~600A	100	200	480
UTS800L MCP	MC-630a	MT-800 200~800A	100	250	604

Type D Coordination (480V)

480V

Metasol MCCB D-type

CB	MC	OLR	kA@400V	Maximum HP	Maximum NEC FLC [A]
UTS150L MCP	MC-6a	MT-12 0.1~10A	65	5	7.6
UTS150L MCP	MC-9a	MT-12 0.1~10A	65	5	7.6
UTS150L MCP	MC-12a	MT-12 0.1~13A	65	7.5	11
UTS150L MCP	MC-18a	MT-12 0.1~18A	65	10	14
UTS150L MCP	MC-9b	MT-32 0.1~10A	65	5	7.6
UTS150L MCP	MC-12b	MT-32 0.1~13A	65	7.5	11
UTS150L MCP	MC-18b	MT-32 0.1~18A	65	10	14
UTS150L MCP	MC-22b	MT-32 0.1~25A	65	15	21
UTS150L MCP	MC-32a	MT-32 0.1~32A	65	20	27
UTS150L MCP	MC-40a	MT-32 0.1~40A	65	20	40
UTS150H MCP	MC-50a	MT-63 4~65A	65	40	52
UTS150L MCP	MC-50a	MT-63 4~65A	100	40	52
UTS150H MCP	MC-65a	MT-63 4~65A	65	50	65
UTS150L MCP	MC-65a	MT-63 4~65A	100	50	65
UTS150H MCP	MC-75a	MT-95 7~75A	65	50	65
UTS150L MCP	MC-75a	MT-95 7~75A	100	50	65
UTS150H MCP	MC-85a	MT-95 7~85A	65	60	77
UTS150L MCP	MC-85a	MT-95 7~85A	100	60	77
UTS150H MCP	MC-100a	MT-95 7~100A	65	75	96
UTS150L MCP	MC-100a	MT-95 7~100A	100	75	96
UTS150H MCP	MC-130a	MT-150 34~130A	65	75	96
UTS150L MCP	MC-130a	MT-150 34~130A	100	75	96
UTS250H MCP	MC-150a	MT-150 34~130A	65	100	124
UTS250L MCP	MC-150a	MT-150 34~130A	100	100	124
UTS250H MCP	MC-185a	MT-225 65~185A	65	125	156
UTS250L MCP	MC-185a	MT-225 65~185A	85	125	156
UTS400H MCP	MC-185a	MT-225 65~185A	65	125	156
UTS400L MCP	MC-185a	MT-225 65~185A	100	125	156
UTS250H MCP	MC-225a	MT-225 65~240A	65	150	180
UTS250L MCP	MC-225a	MT-225 65~240A	85	150	180
UTS400H MCP	MC-225a	MT-225 65~240A	65	150	180
UTS400L MCP	MC-225a	MT-225 65~240A	100	150	180
UTS400H MCP	MC-265a	MT-400 85~330A	65	200	240
UTS400L MCP	MC-265a	MT-400 85~330A	100	200	240
UTS400H MCP	MC-330a	MT-400 85~330A	65	200	240
UTS400L MCP	MC-330a	MT-400 85~330A	100	200	240
UTS600H MCP	MC-400a	MT-400 85~400A	65	300	361
UTS600L MCP	MC-400a	MT-400 85~400A	100	300	361
UTS800L MCP	MC-500a	MT-800 200~600A	100	400	477
UTS800L MCP	MC-630a	MT-800 200~800A	100	500	590

Type D Coordination (600V)

600V

Metasol MCCB D-type

CB	MC	OLR	kA@600V	Maximum HP	Maximum NEC FLC [A]
UTS150L MCP	MC-6a	MT-12 0.1~10A	25	7.5	9
UTS150L MCP	MC-9a	MT-12 0.1~10A	25	7.5	9
UTS150L MCP	MC-12a	MT-12 0.1~13A	25	10	11
UTS150L MCP	MC-18a	MT-12 0.1~18A	25	15	17
UTS150L MCP	MC-9b	MT-32 0.1~10A	25	7.5	9
UTS150L MCP	MC-12b	MT-32 0.1~13A	25	10	11
UTS150L MCP	MC-18b	MT-32 0.1~18A	25	15	17
UTS150L MCP	MC-22b	MT-32 0.1~25A	25	20	22
UTS150L MCP	MC-32a	MT-32 0.1~32A	25	25	27
UTS150L MCP	MC-40a	MT-32 0.1~32A	25	25	32
UTS150H MCP	MC-50a	MT-63 4~65A	25	50	52
UTS150L MCP	MC-50a	MT-63 4~65A	50	50	62
UTS150H MCP	MC-65a	MT-63 4~65A	25	60	62
UTS150L MCP	MC-65a	MT-63 4~65A	50	60	62
UTS150H MCP	MC-75a	MT-95 7~75A	25	60	77
UTS150L MCP	MC-75a	MT-95 7~75A	50	60	77
UTS150H MCP	MC-85a	MT-95 7~85A	25	75	77
UTS150L MCP	MC-85a	MT-95 7~85A	50	75	77
UTS150H MCP	MC-100a	MT-95 7~85A	25	75	77
UTS150L MCP	MC-100a	MT-95 7~85A	50	75	77
UTS150H MCP	MC-130a	MT-150 65~185A	25	75	77
UTS150L MCP	MC-130a	MT-150 65~185A	50	75	77
UTS150H MCP	MC-150a	MT-150 65~185A	25	75	77
UTS150L MCP	MC-150a	MT-150 65~185A	50	75	77
UTS250H MCP	MC-185a	MT-225 65~185A	25	125	125
UTS250L MCP	MC-185a	MT-225 65~185A	50	125	125
UTS400H MCP	MC-185a	MT-225 65~185A	25	125	125
UTS400L MCP	MC-185a	MT-225 65~185A	50	125	125
UTS250H MCP	MC-225a	MT-225 65~185A	25	150	144
UTS250L MCP	MC-225a	MT-225 65~185A	50	150	144
UTS400H MCP	MC-225a	MT-225 65~185A	25	150	144
UTS400L MCP	MC-225a	MT-225 65~185A	50	150	144
UTS400H MCP	MC-265a	MT-400 85~240A	25	200	192
UTS400L MCP	MC-265a	MT-400 85~240A	50	200	192
UTS400H MCP	MC-330a	MT-400 85~330A	25	200	242
UTS400L MCP	MC-330a	MT-400 85~330A	50	200	242
UTS600H MCP	MC-400a	MT-400 85~400A	25	300	289
UTS600L MCP	MC-400a	MT-400 85~400A	50	300	289
UTS800L MCP	MC-500a	MT-800 200~400A	50	400	382
UTS800L MCP	MC-630a	MT-800 200~600A	50	500	472

Rated UL 508 combination motor controller Type-C

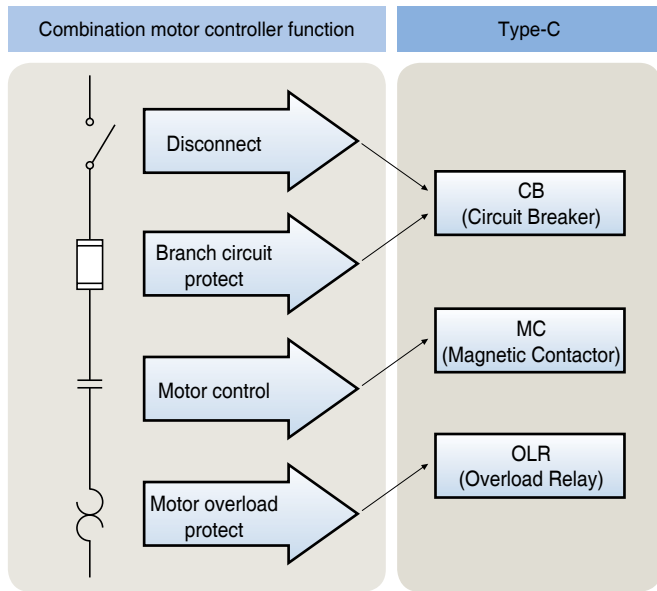

480V

CB	MC	OLR	kA@480V	Maximum HP	Maximum NEC FLC [A]
TD125HU 15A	MC-6a	MT-12 0.1-10A	65	5	7.6
TD125HU 15A	MC-9a	MT-12 0.1-10A	65	5	7.6
TD125HU 15-20A	MC-12a	MT-12 0.1-13A	65	7.5	11
TD125HU 15-20A	MC-18a	MT-12 0.1-18A	65	10	14
TD125HU 15A	MC-9b	MT-32 0.1-10A	65	5	7.6
TD125HU 15-20A	MC-12b	MT-32 0.1-13A	65	7.5	11
TD125HU 15-30A	MC-18b	MT-32 0.1-18A	65	10	14
TD125HU 15-30A	MC-22b	MT-32 0.1-25A	65	15	21
TD125HU 40A	MC-32a	MT-32 0.1-32A	65	20	27
TD125HU 40A	MC-40a	MT-32 0.1-40A	65	30	40
TD125HU 60-100A	MC-50a	MT-63 4-65A	65	40	52
TD125HU 60-100A	MC-65a	MT-63 4-65A	65	50	65
TS250HU 150A	MC-75a	MT-95 7-75A	65	50	65
TS250HU 150A	MC-85a	MT-95 7-85A	65	60	77
TS250HU 150-200A	MC-100a	MT-95 7-100A	65	75	96
TS250HU 250A	MC-130a	MT-150 34-130A	65	75	96
TS250HU 250A	MC-150a	MT-150 34-130A	65	100	124

Rated UL 508 combination motor controller Type-C

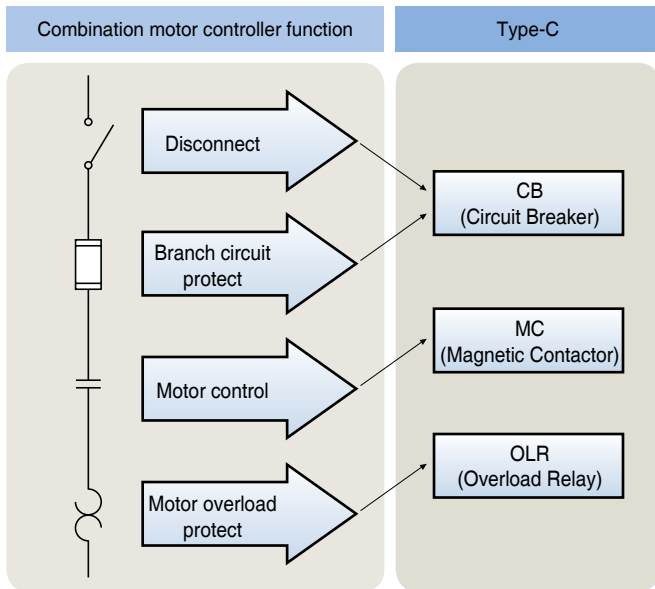

600V

CB	MC	OLR	kA@600V	Maximum HP	Maximum NEC FLC [A]
TD125HU 15A	MC-6a	MT-12 0.1~10A	14	7.5	9
TD125HU 15A	MC-9a	MT-12 0.1~10A	14	7.5	9
TD125HU 15~20A	MC-12a	MT-12 0.1~13A	14	10	11
TD125HU 15~20A	MC-18a	MT-12 0.1~18A	14	15	17
TD125HU 15A	MC-9b	MT-32 0.1~10A	14	7.5	9
TD125HU 15~20A	MC-12b	MT-32 0.1~13A	14	10	11
TD125HU 15~30A	MC-18b	MT-32 0.1~18A	14	15	17
TD125HU 15~30A	MC-22b	MT-32 0.1~25A	14	20	22
TD125HU 40A	MC-32a	MT-32 0.1~32A	14	25	27
TD125HU 40~50A	MC-40a	MT-32 0.1~40A	14	30	32
TD125HU 60~100A	MC-50a	MT-63 4~65A	14	50	52
TD125HU 60~100A	MC-65a	MT-63 4~65A	14	60	62
TS250HU 150A	MC-75a	MT-95 7~75A	18	60	62
TS250HU 150~200A	MC-85a	MT-95 7~85A	18	75	77
TS250HU 150~200A	MC-100a	MT-95 7~100A	18	75	77
TS250HU 250A	MC-130a	MT-150 34~130A	18	75	77
TS250HU 250A	MC-150a	MT-150 34~130A	18	75	77

Rated UL 508 combination motor controller Type-F

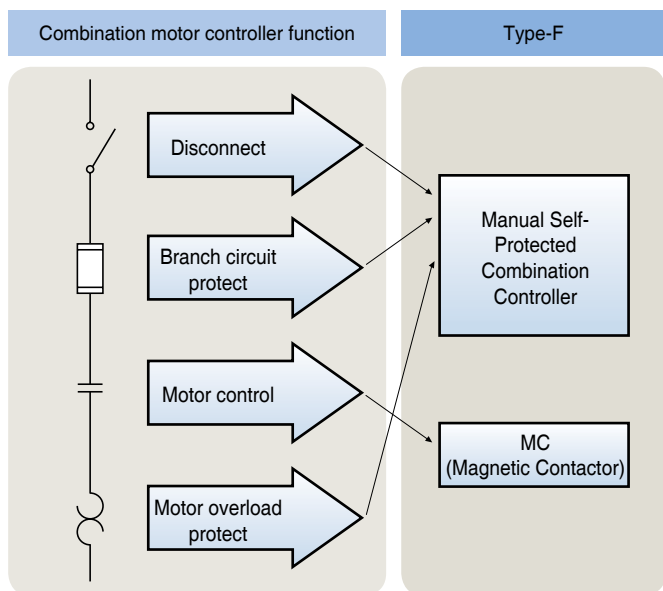

32AF Rotary operation, High interruption

Manual Self-Protected	Adjustment range (A)	Short circuit rating (kA)			MC (Applied contactor)	
		240V	480Y/277V	600Y/347V	Susol	Metasol
MMS-32H-0.16	0.1~0.16	100	65	25	MC-9	MC-6a/MC-9a/MC-9b
MMS-32H-0.25	0.16~0.25	100	65	25	MC-9	MC-6a/MC-9a/MC-9b
MMS-32H-0.4	0.25~0.4	100	65	25	MC-9	MC-6a/MC-9a/MC-9b
MMS-32H-0.63	0.4~0.63	100	65	25	MC-9	MC-6a/MC-9a/MC-9b
MMS-32H-1	0.63~1	100	65	25	MC-9	MC-6a/MC-9a/MC-9b
MMS-32H-1.6	1~1.6	100	65	25	MC-9	MC-6a/MC-9a/MC-9b
MMS-32H-2.5	1.6~2.5	100	65	25	MC-12	MC-12a/MC-12b
MMS-32H-4	2.5~4	100	65	25	MC-12	MC-12a/MC-12b
MMS-32H-6	4~6	100	65	25	MC-18	MC-18a/MC-18b
MMS-32H-8	5~8	100	65	10	MC-18	MC-18a/MC-18b
MMS-32H-10	6~10	100	65	10	MC-18	MC-18a/MC-18b
MMS-32H-13	9~13	100	65	10	MC-25	MC-22b/MC-25a
MMS-32H-17	11~17	100	30	10	MC-25	MC-22b/MC-25a
MMS-32H-22	14~22	100	30	10	MC-25	MC-22b/MC-25a
MMS-32H-26	18~26	100	30	10	MC-32	MC-32a
MMS-32H-32	22~32	100	30	10	MC-32	MC-32a
MMS-32H-40	28~40	100	30	10	-	MC-35a/MC-40a

Rated UL 508 combination motor controller Type-F

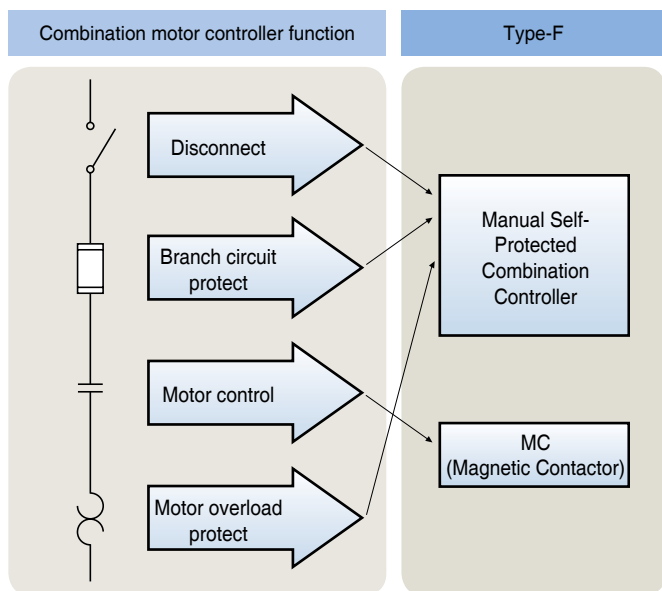

63AF Rotary operation, standard interruption

Manual Self-Protected	Adjustment range (A)	Short circuit rating (kA)			MC (Applied contactor)	
		240V	480Y/277V	600Y/347V	Susol	Metasol
MMS-63S-10	6~10	100	50	10	MC-35	MC-50a
MMS-63S-13	9~13	100	50	10	MC-35	MC-50a
MMS-63S-17	11~17	100	40	10	MC-35	MC-50a
MMS-63S-22	14~22	100	40	10	MC-35	MC-50a
MMS-63S-26	18~26	100	40	10	MC-35	MC-50a
MMS-63S-32	22~32	100	40	10	MC-35	MC-50a
MMS-63S-40	28~40	100	40	10	MC-40	MC-50a
MMS-63S-50	34~50	100	40	10	MC-50	MC-50a
MMS-63S-63	45~63	100	40	10	MC-63	MC-65a
MMS-63S-65	47~65	100	40	10	-	MC-65a

63AF Rotary operation, High interruption

Manual Self-Protected	Adjustment range (A)	Short circuit rating (kA)			MC (Applied contactor)	
		240V	480Y/277V	600Y/347V	Susol	Metasol
MMS-63H-10	6~10	100	65	25	MC-35	MC-50a
MMS-63H-13	9~13	100	65	25	MC-35	MC-50a
MMS-63H-17	11~17	100	50	10	MC-35	MC-50a
MMS-63H-22	14~22	100	50	10	MC-35	MC-50a
MMS-63H-26	18~26	100	50	10	MC-35	MC-50a
MMS-63H-32	22~32	100	50	10	MC-35	MC-50a
MMS-63H-40	28~40	100	50	10	MC-40	MC-50a
MMS-63H-50	34~50	100	50	10	MC-50	MC-50a
MMS-63H-63	45~63	100	50	10	MC-63	MC-65a
MMS-63H-65	47~65	100	40	10	-	MC-65a

Rated UL 508 combination motor controller Type-F

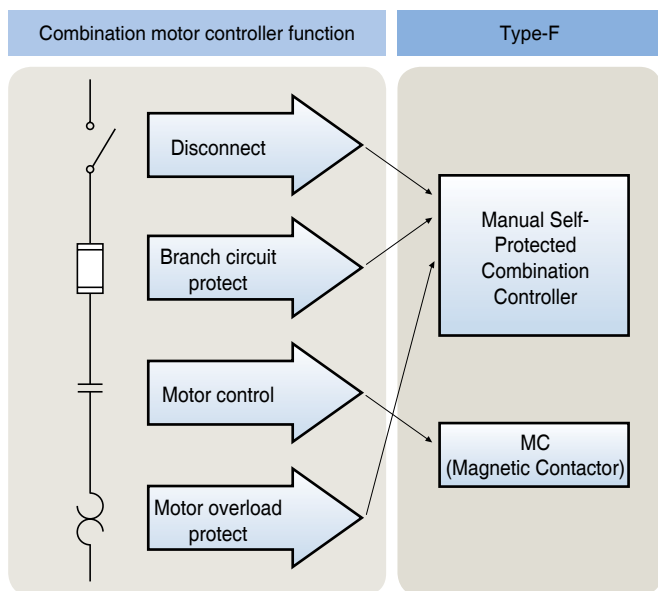

100AF Rotary operation, Standard interruption

Manual Self-Protected	Adjustment range (A)	Short circuit rating (kA)			MC (Applied contactor)	
		240V	480Y/277V	600Y/347V	Susol	Metasol
MMS-100S-17	11~17	100	50	10	MC-65	MC-75a
MMS-100S-22	14~22	100	50	10	MC-65	MC-75a
MMS-100S-26	18~26	100	50	10	MC-65	MC-75a
MMS-100S-32	22~32	100	50	10	MC-65	MC-75a
MMS-100S-40	28~40	100	50	10	MC-65	MC-75a
MMS-100S-50	34~50	100	50	10	MC-65	MC-75a
MMS-100S-63	45~63	100	40	10	MC-65	MC-75a
MMS-100S-75	55~75	100	40	10	MC-75	MC-75a
MMS-100S-90	70~90	100	40	10	MC-85	MC-85a
MMS-100S-100	80~100	100	40	10	MC-95	MC-100a

100AF Rotary operation, High interruption

Manual Self-Protected	Adjustment range (A)	Short circuit rating (kA)			MC (Applied contactor)	
		240V	480Y/277V	600Y/347V	Susol	Metasol
MMS-100H-17	11~17	100	65	25	MC-65	MC-75a
MMS-100H-22	14~22	100	65	20	MC-65	MC-75a
MMS-100H-26	18~26	100	65	20	MC-65	MC-75a
MMS-100H-32	22~32	100	65	20	MC-65	MC-75a
MMS-100H-40	28~40	100	65	20	MC-65	MC-75a
MMS-100H-50	34~50	100	65	20	MC-65	MC-75a
MMS-100H-63	45~63	100	50	10	MC-65	MC-75a
MMS-100H-75	55~75	100	50	10	MC-75	MC-75a
MMS-100H-90	70~90	100	50	10	MC-85	MC-85a
MMS-100H-100	80~100	100	50	10	MC-95	MC-100a

3-pole contactors dimension (18AF/22AF)

[mm]

MC-6a~18a AC

1NO or 1NC

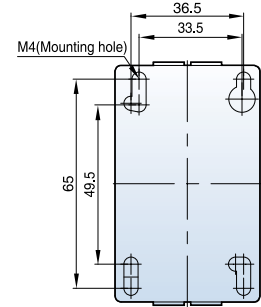
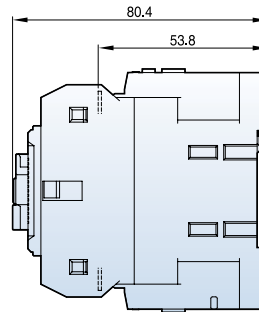
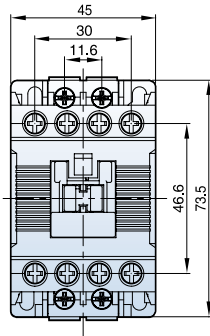

0.3kg

MC-6a~18a DC

1NO or 1NC

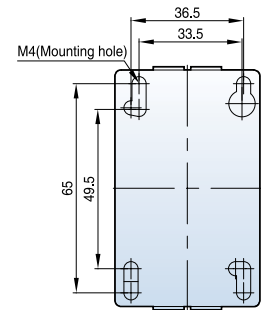
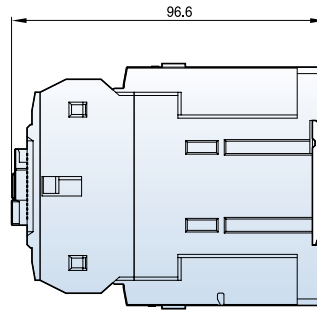
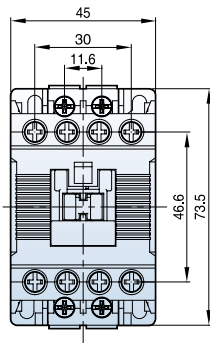

0.5kg

MC-9b~22b AC

1NO1NC

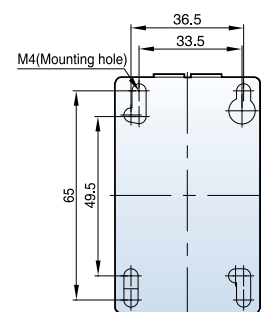
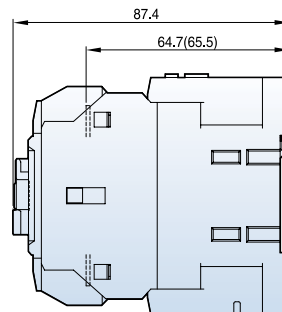
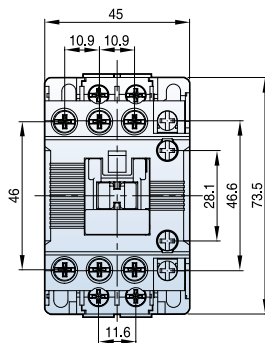

0.3kg

* () MC-18b, 22b

MC-9b~22b DC

1NO1NC

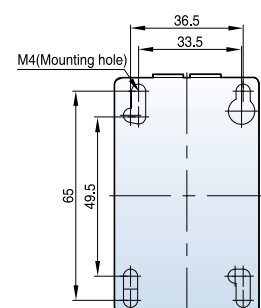
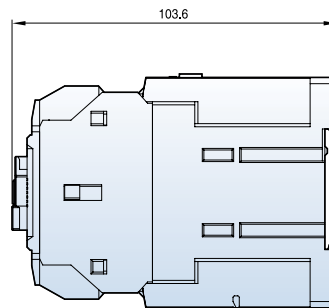
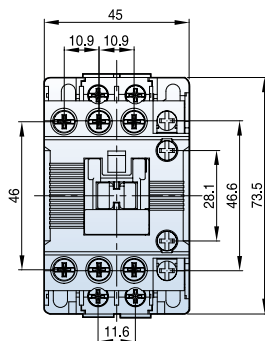

0.5kg

3-pole contactors dimension (40AF)

[mm]

MC-32a~40a AC

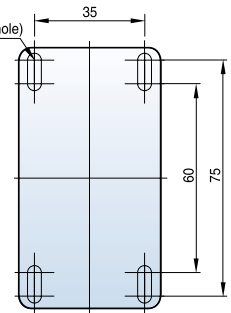
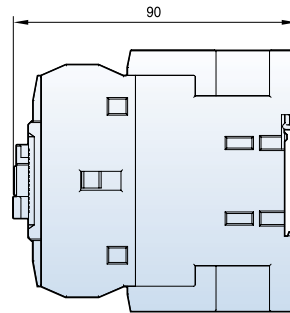
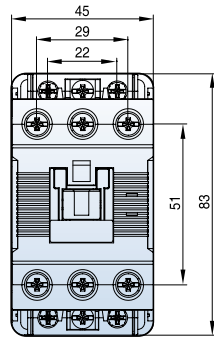

0.4kg

MC-32a~40a DC

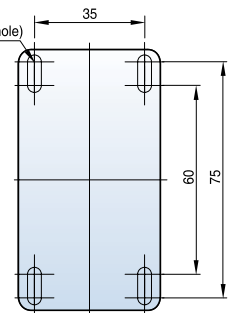
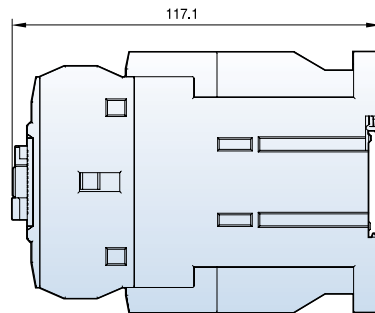
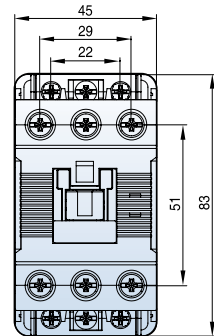

0.6kg

MC-32a~40a AC
2NO2NC

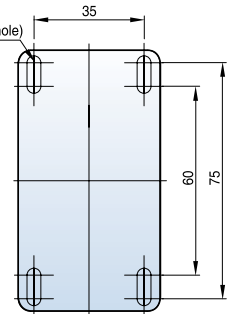
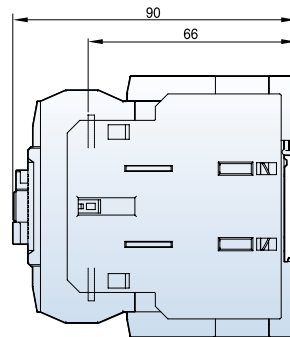
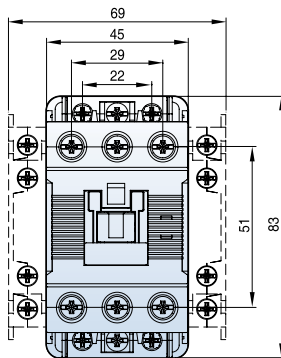

0.5kg

MC-32a~40a DC
2NO2NC

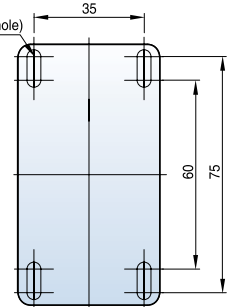
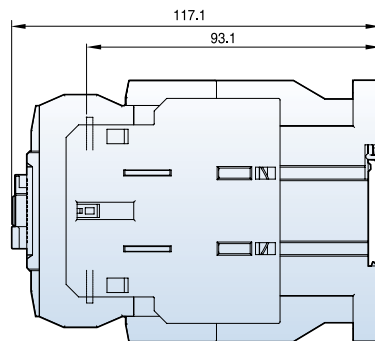
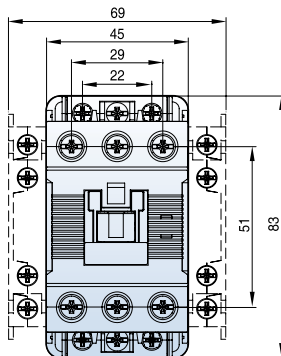

0.8kg

3-pole contactors dimension (65AF)

[mm]

MC-50a~65a AC

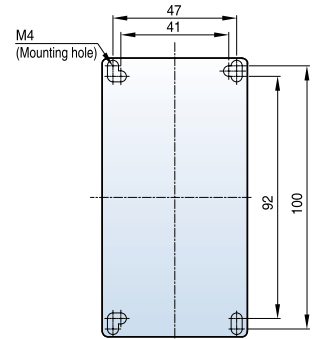
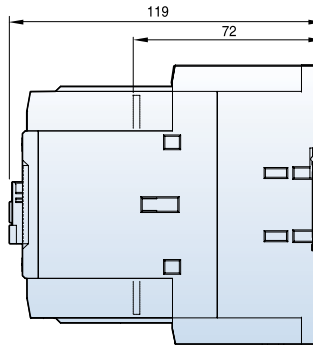
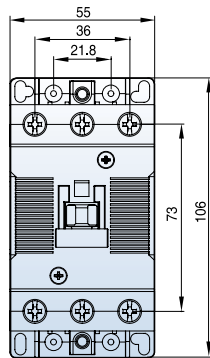

0.9kg

MC-50a~65a DC

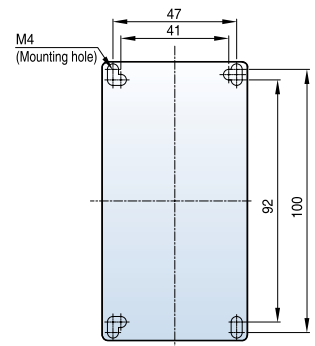
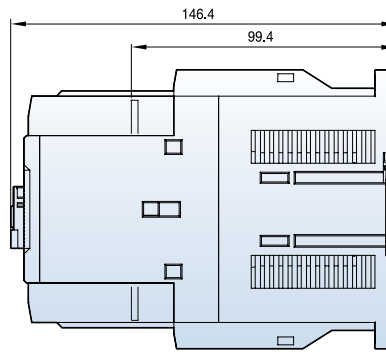
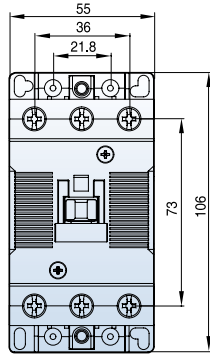

1.2kg

MC-50a~65a AC

2NO2NC

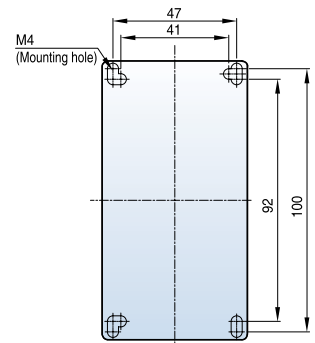
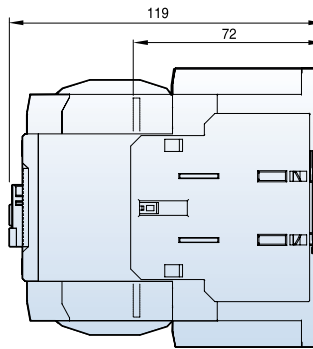
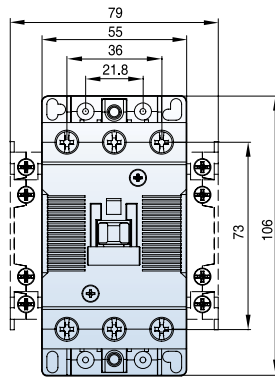

1kg

MC-50a~65a DC

2NO2NC

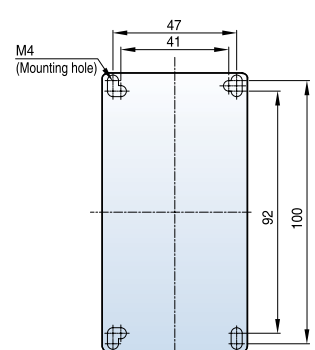
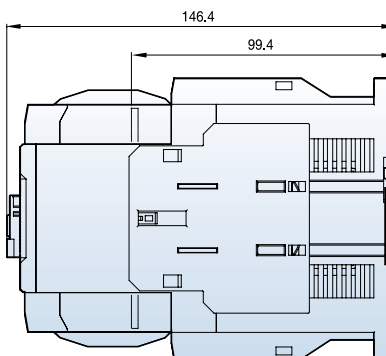
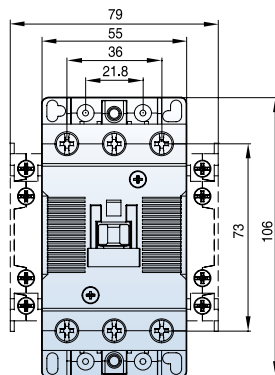

1.3kg

3-pole contactors dimension (100AF)

[mm]

MC-75a~100a AC

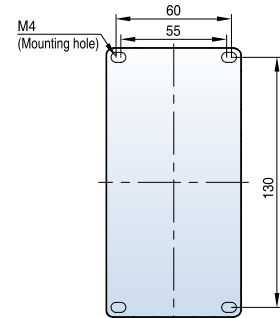
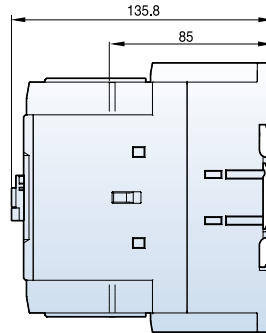
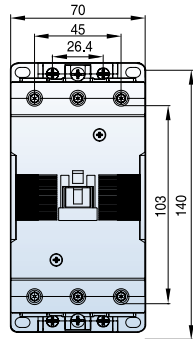

1.8kg

MC-75a~100a DC

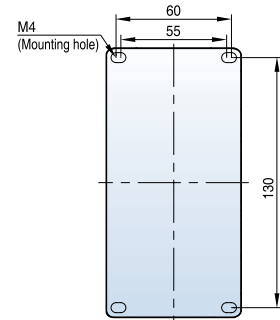
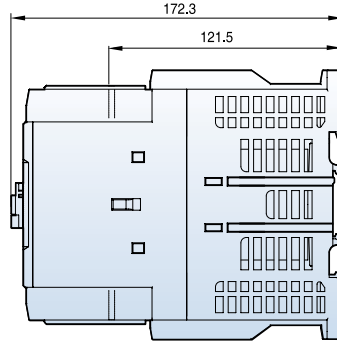
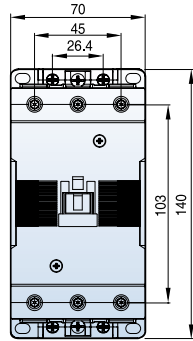

2.7kg

MC-75a~100a AC
2NO2NC

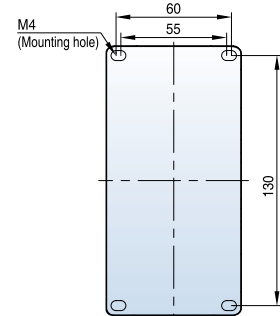
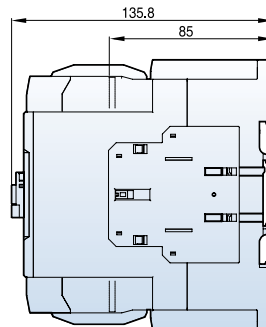
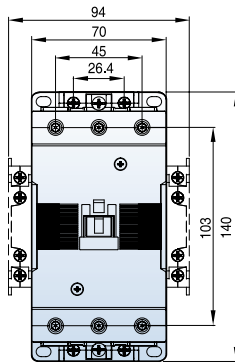

1.9kg

MC-75a~100a DC
2NO2NC

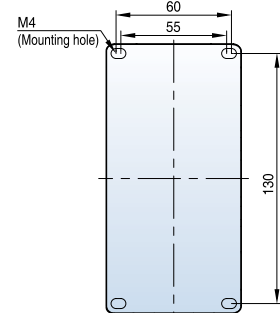
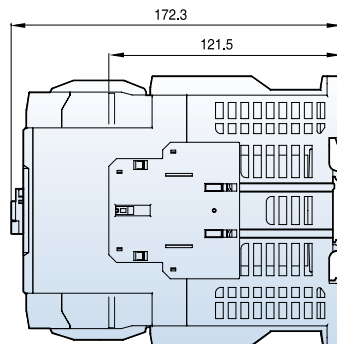
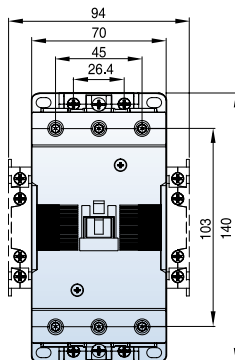

2.8kg

3-pole contactors dimension (150AF~400AF)

MC-130a

MC-150a

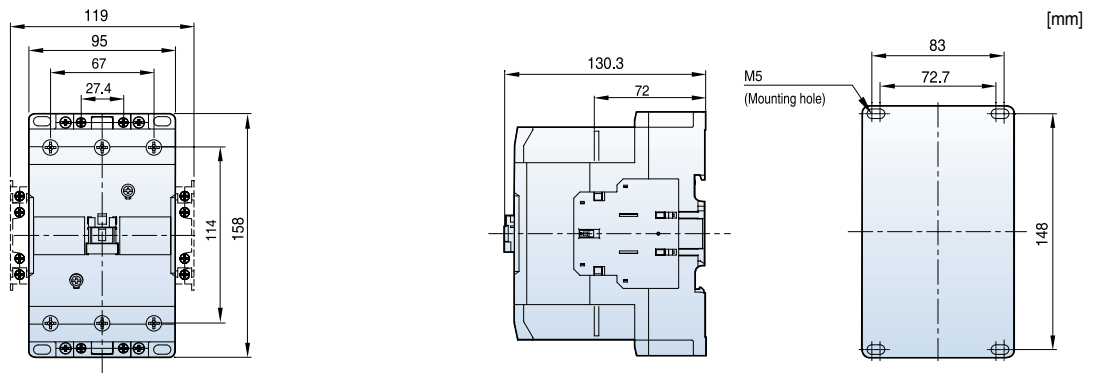

2.4kg

MC-185a

MC-225a

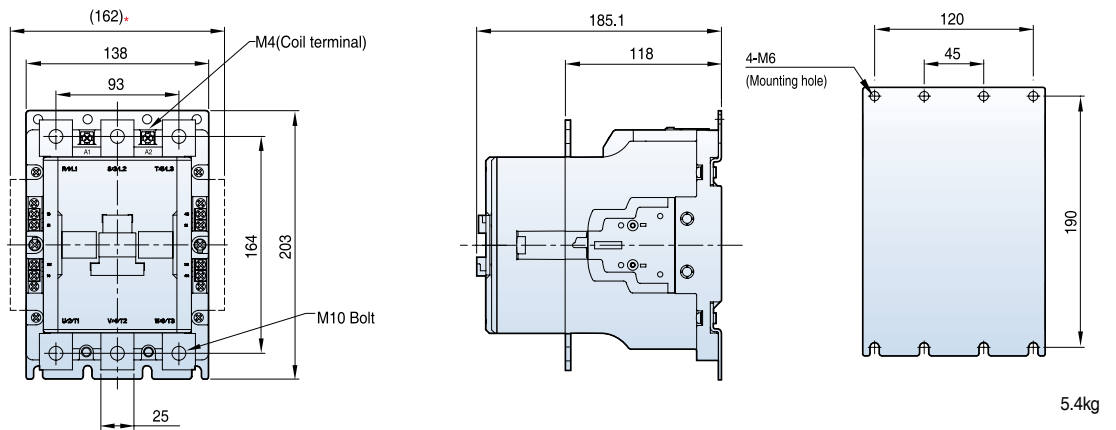

5.4kg

MC-265a

MC-330a

MC-400a

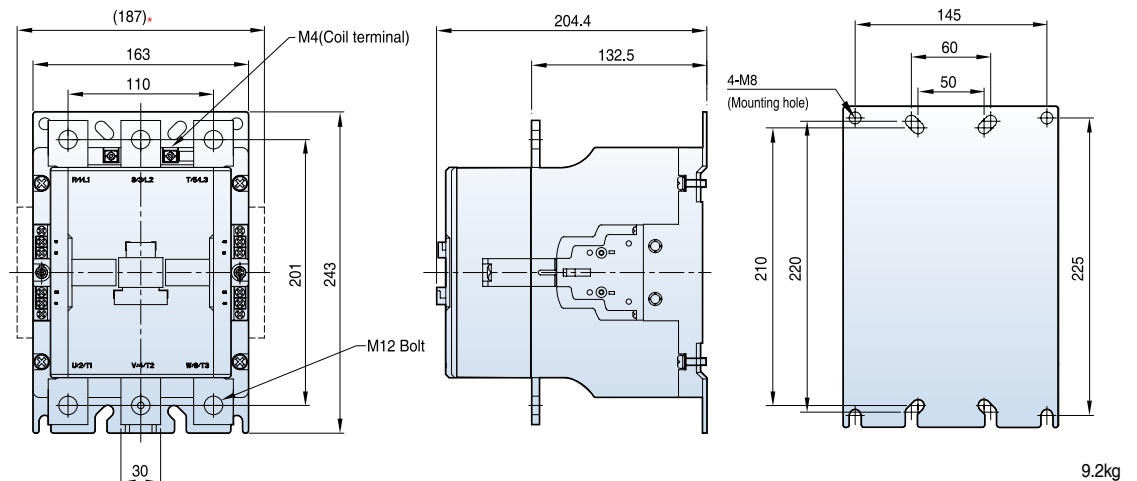

9.2kg

* Optional auxiliary contact unit (side mount type)

3-pole contactors dimension (800AF~2100AF)

MC-500a

MC-630a

MC-800a

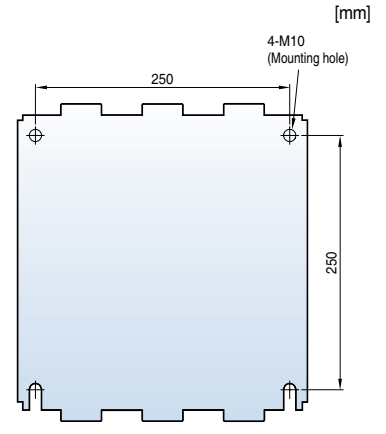
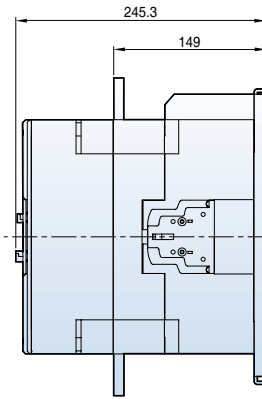
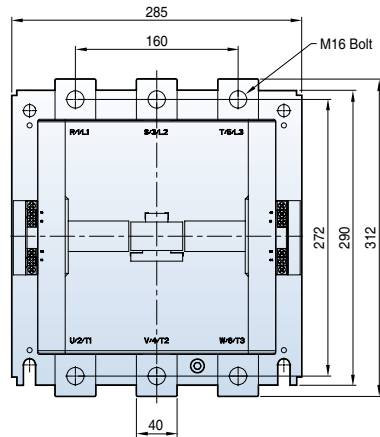

22.4kg

MC-1260a

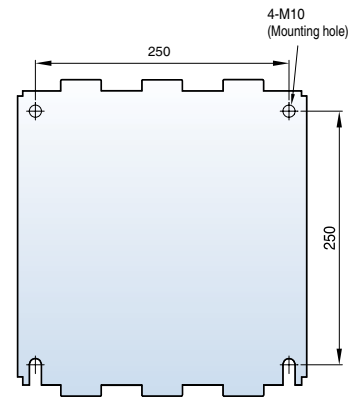
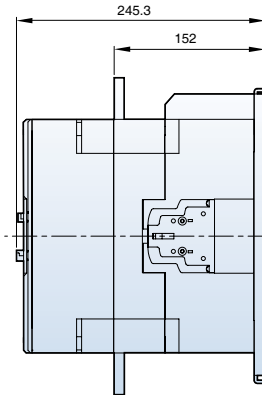
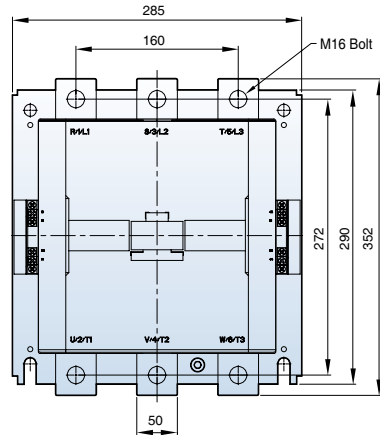

MC-1400a

MC-1700a

MC-2100a

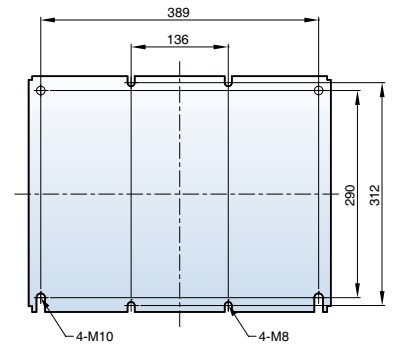
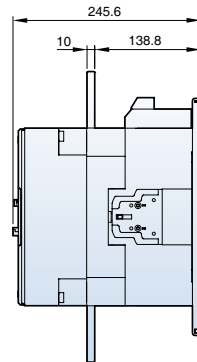
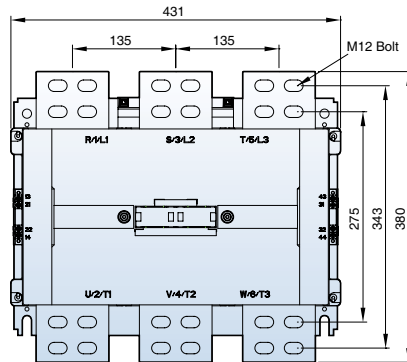

Motor starters dimension (18AF~40AF)

[mm]

MS-6a~18a

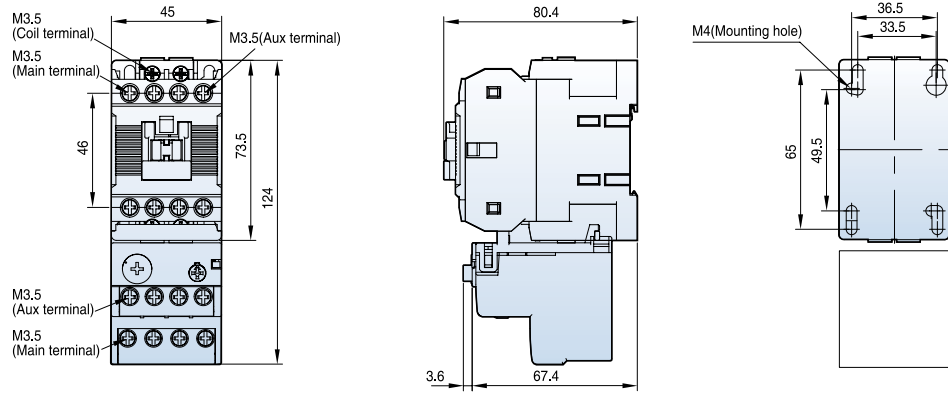

0.5kg

MS-9b~22b

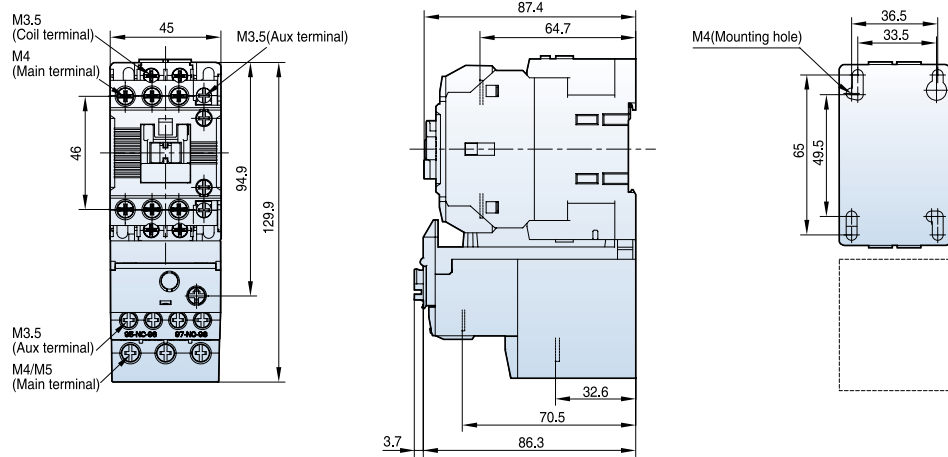

0.5kg

MS-32a~40a

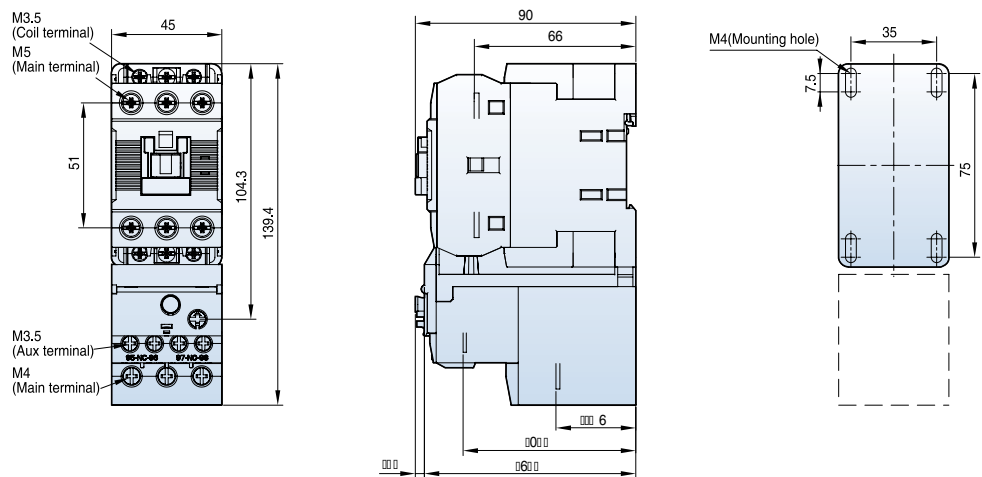

0.6kg

Motor starters dimension (65AF~150AF)

MS-50a~65a

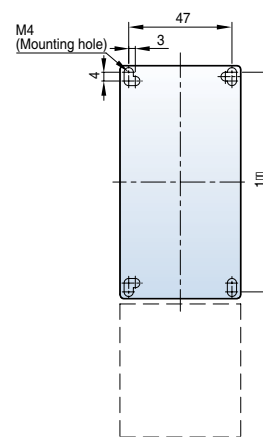
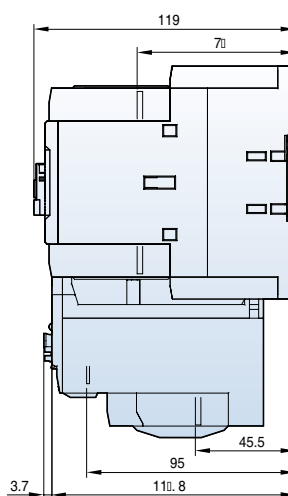
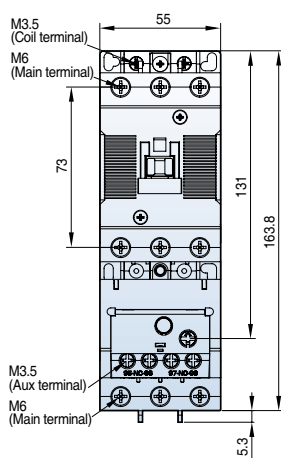

[mm]

1.3kg

MS-75a~100a

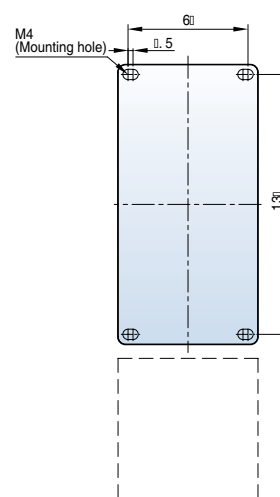
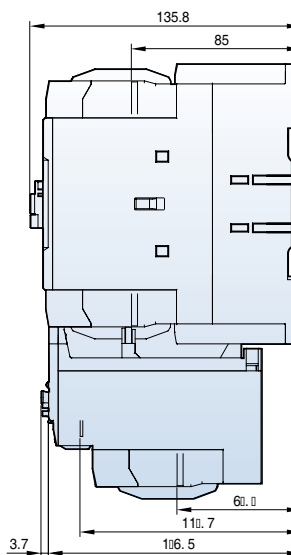
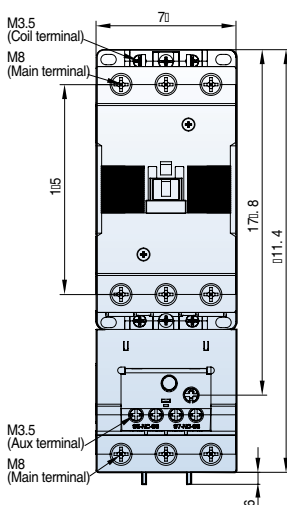

2.3kg

MS-130a

MS-150a

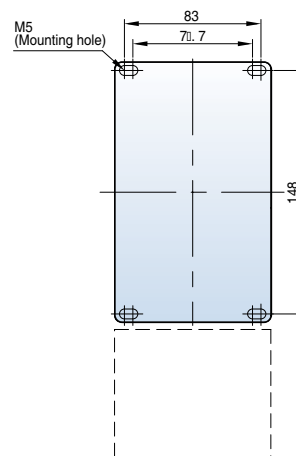
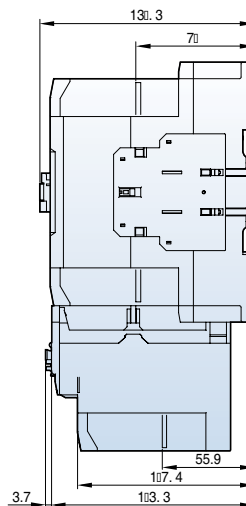
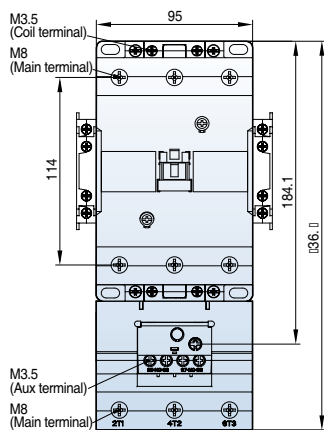

2.9kg

Motor starters dimension (185AF~800AF)

- MS-185a
- MS-225a

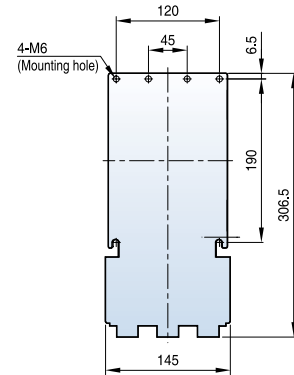
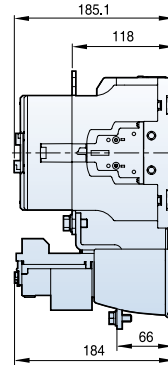
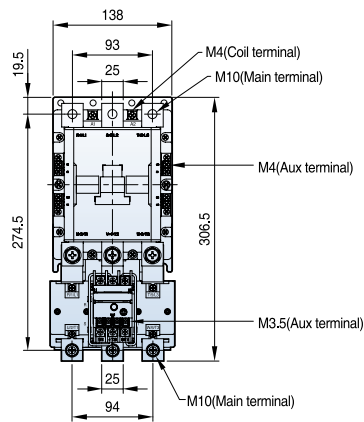

[mm]

7.9kg

- MS-265a
- MS-330a
- MS-400a

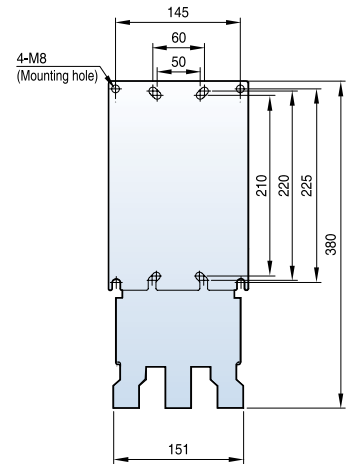
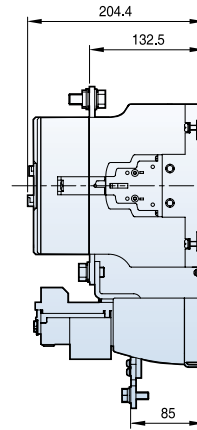
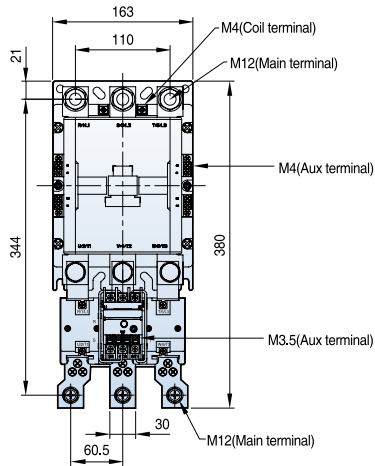

11.8kg

- MS-500a
- MS-630a
- MS-800a

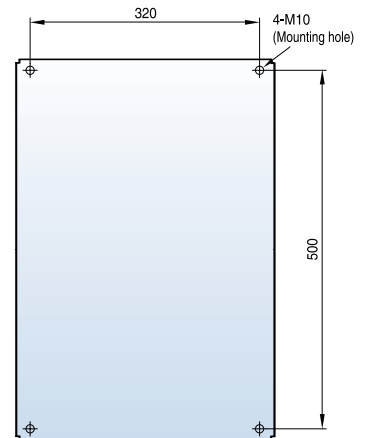
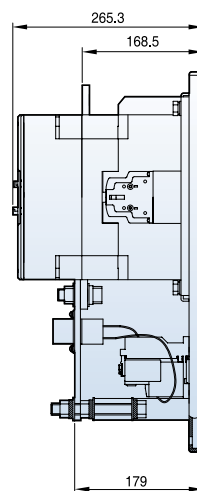
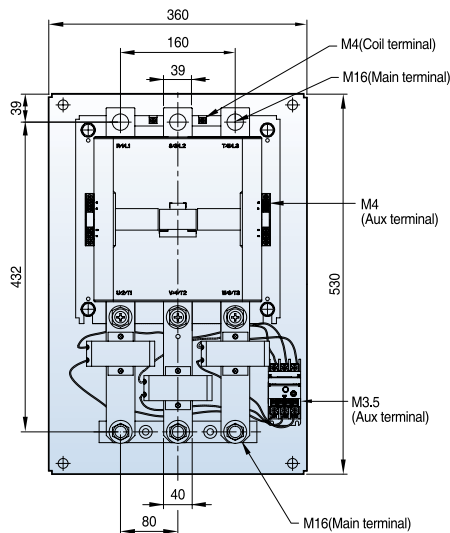

28kg

Reversing contactors and starters dimension (18AF)

[mm]

MC-6aR~18aR AC

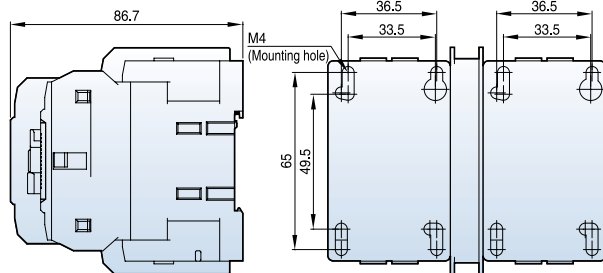
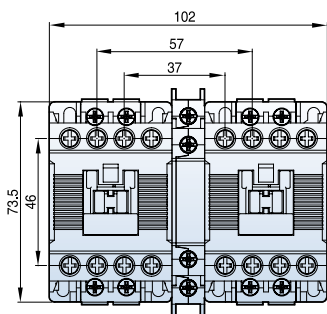

0.7kg

MC-6aR~18aR DC

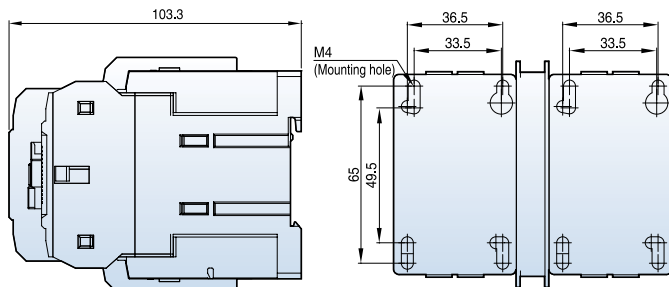
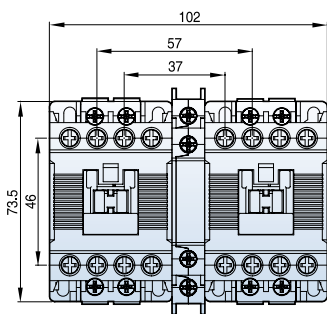

1kg

MS-6aR~18aR AC

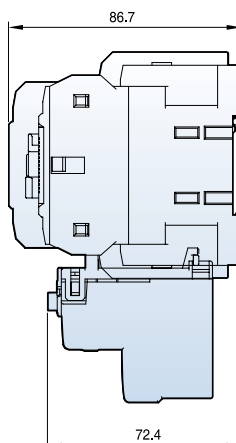
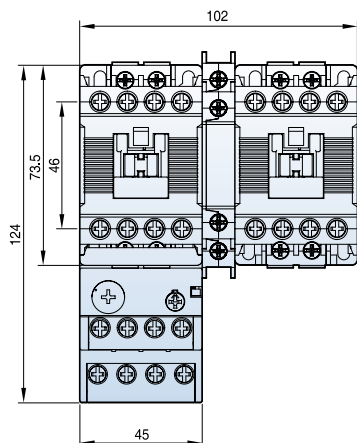

0.9kg

Reversing contactors and starters dimension (22AF)

[mm]

MC-9bR-22bR AC

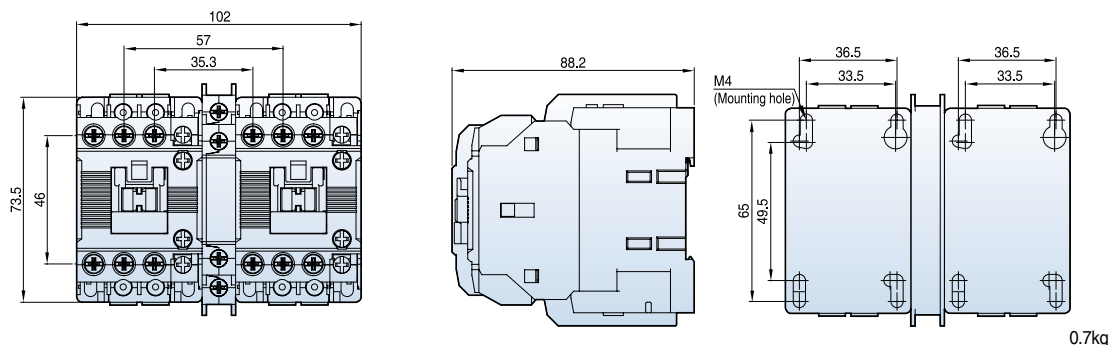

0.7kg

MC-9bR-22bR DC

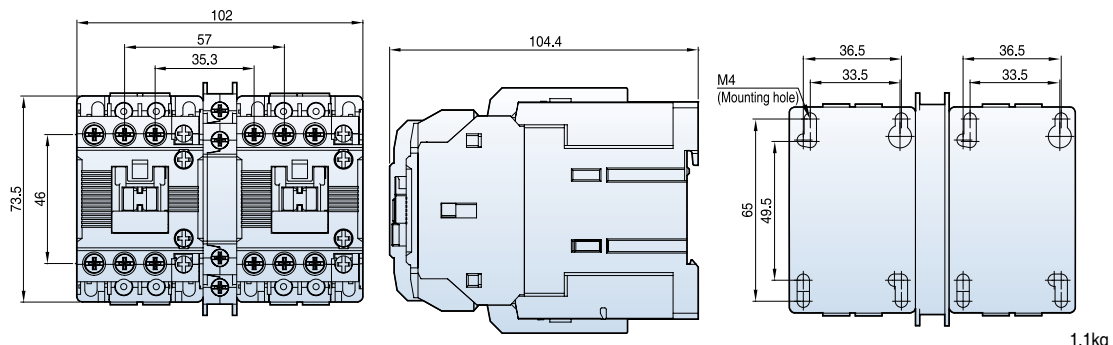

1.1kg

MS-9bR-22bR AC

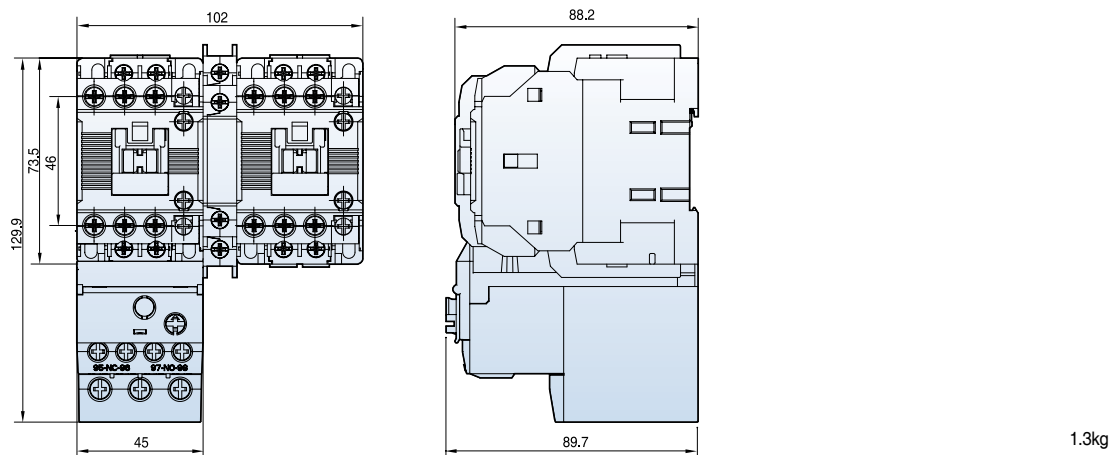

1.3kg

Reversing contactors and starters dimension (40AF)

MC-32aR-40aR AC

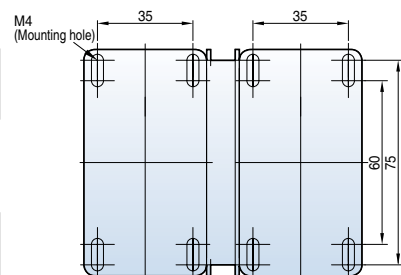
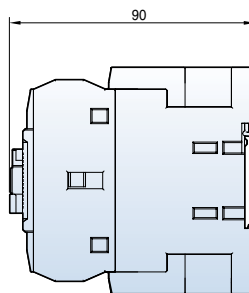
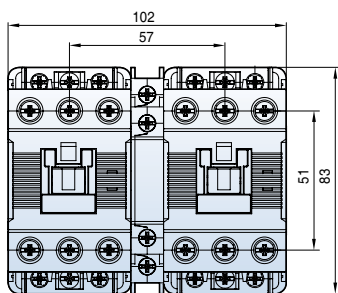

[mm]

0.9kg

MC-32aR-40aR DC

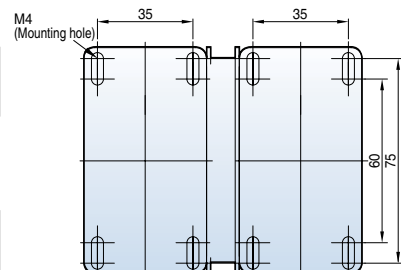
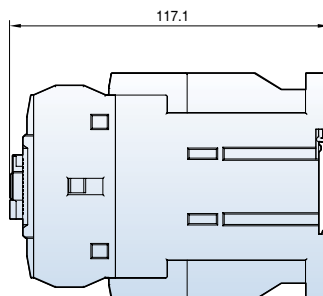
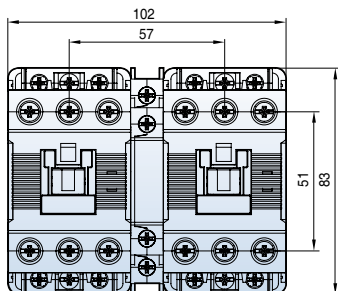

1.4kg

MS-32aR-40aR AC

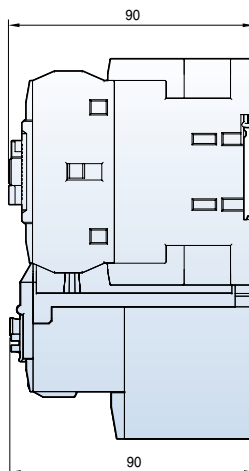
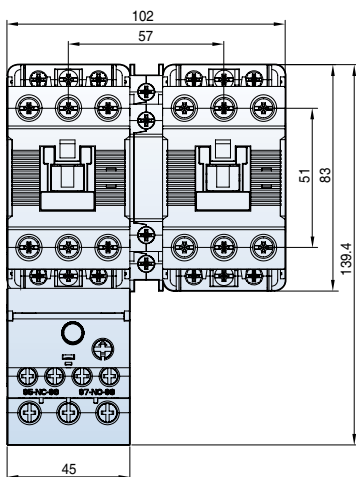

1.1kg

Reversing contactors and starters dimension (65AF)

MC-50aR~65aR AC

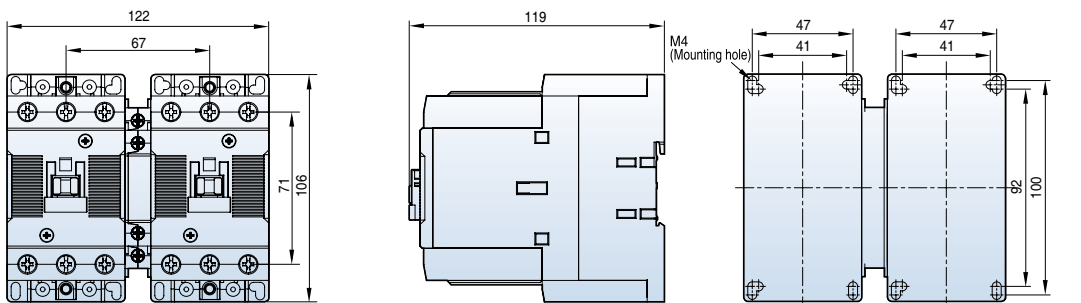

1.8kg

MC-50aR~65aR DC

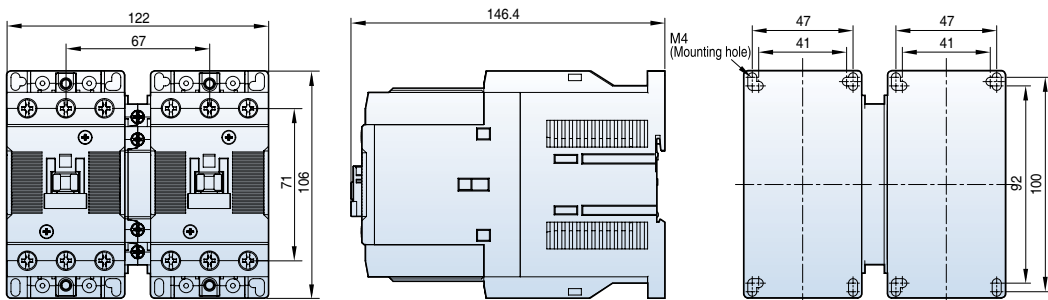

2.4kg

MS-50aR~65aR AC

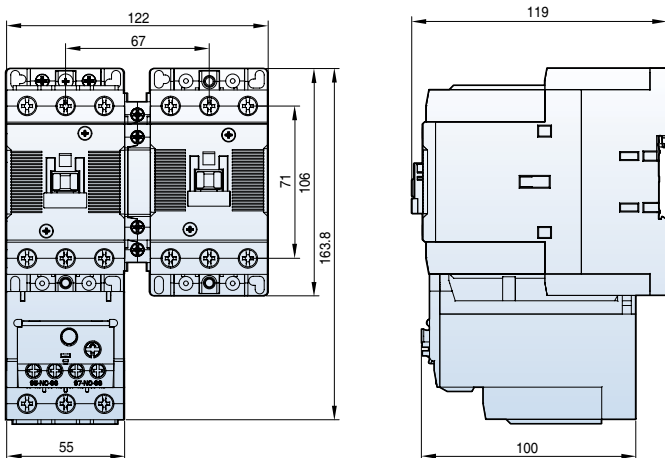

1.9kg

Reversing contactors and starters dimension (100AF)

MC-75aR~100aR AC

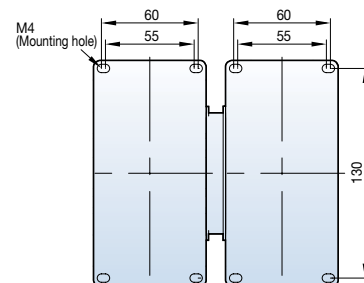
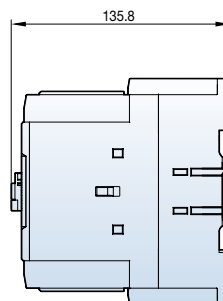
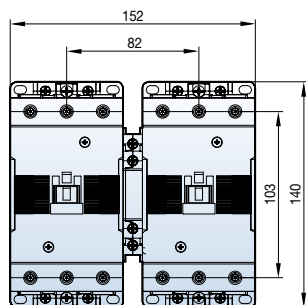

[mm]

3.3kg

MC-75aR~100aR DC

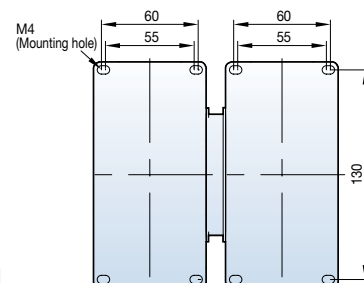
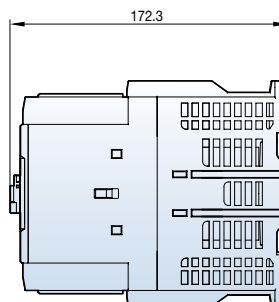
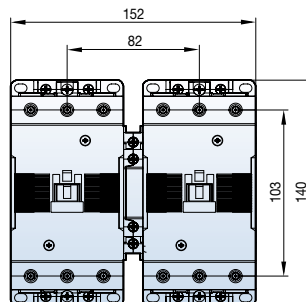

5.2kg

MS-75aR~100aR AC

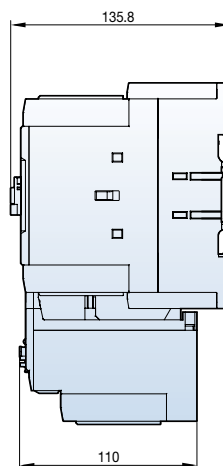
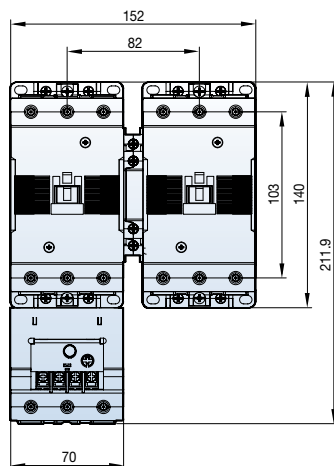

3.8kg

Reversing contactors and starters dimension (150~800AF)

MC-130aR

MC-150aR

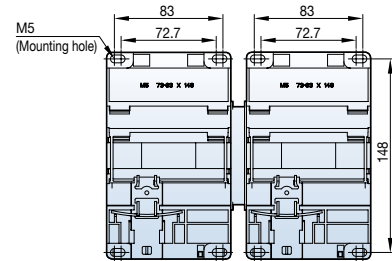
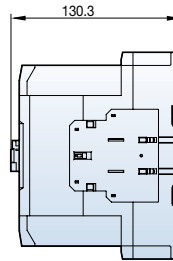
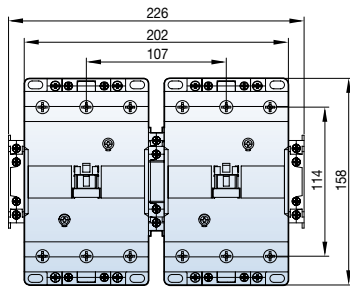

[mm]

4.3kg

MC-185aR

MC-225aR

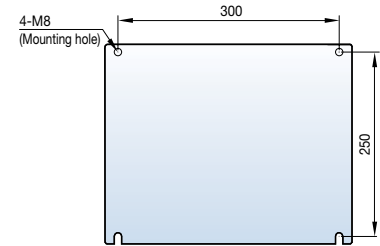
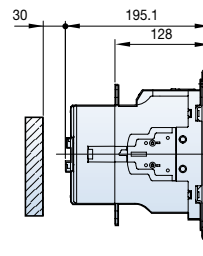
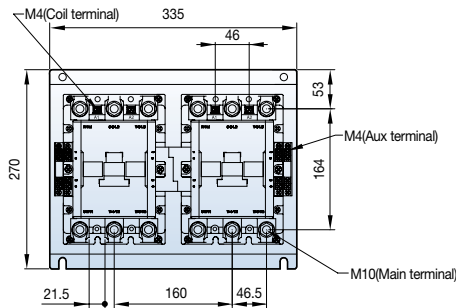

12.9kg

MC-265aR

MC-330aR

MC-400aR

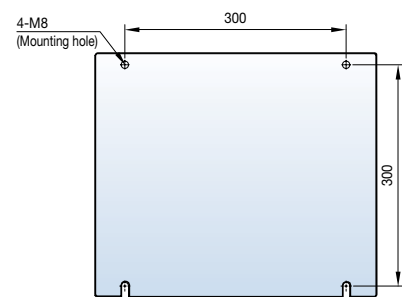
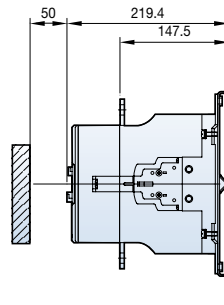
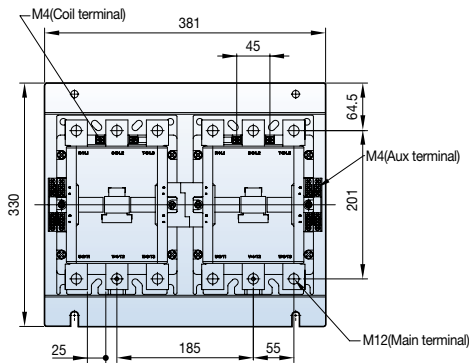

21.4kg

MC-500aR

MC-630aR

MC-800aR

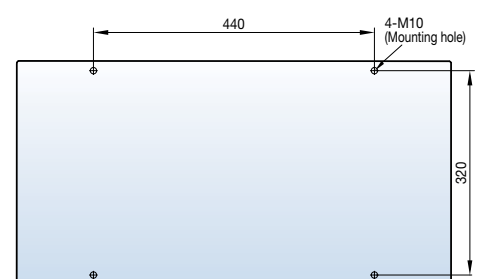
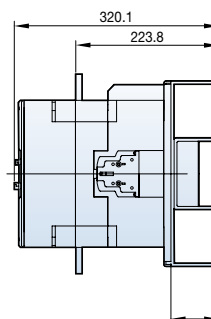
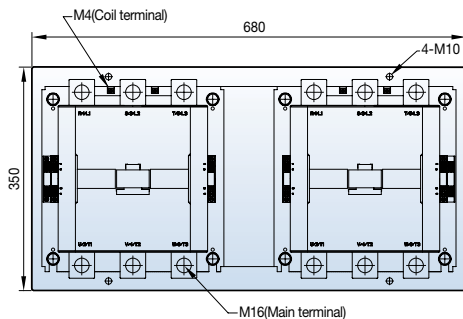

60kg

Reversing contactors and starters dimension (150~400AF)

[mm]

- MS-130aR AC
- MS-150aR AC

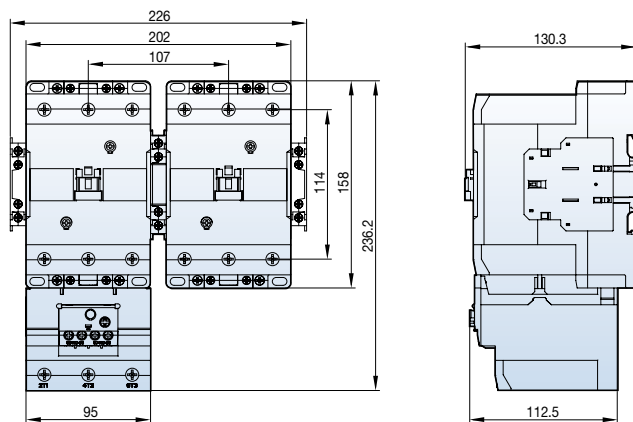

5kg

- MS-185aR AC
- MS-225aR AC

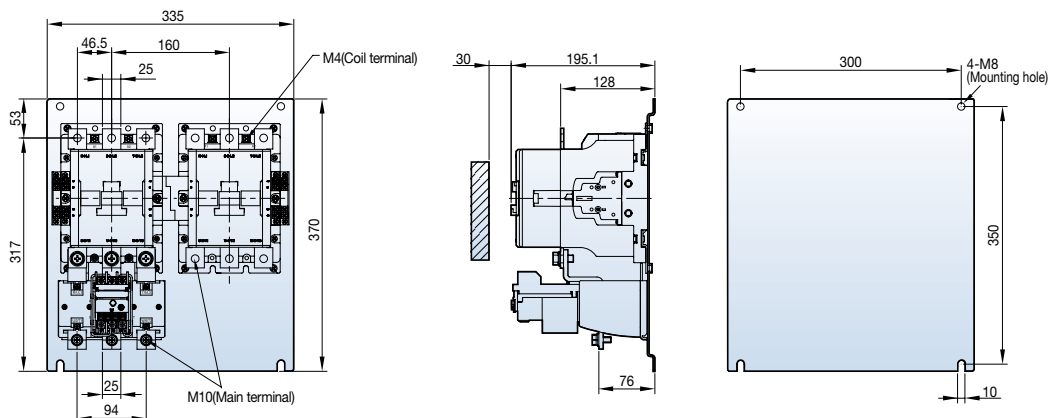

15.5kg

- MS-265aR DC
- MS-330aR DC
- MS-400aR DC

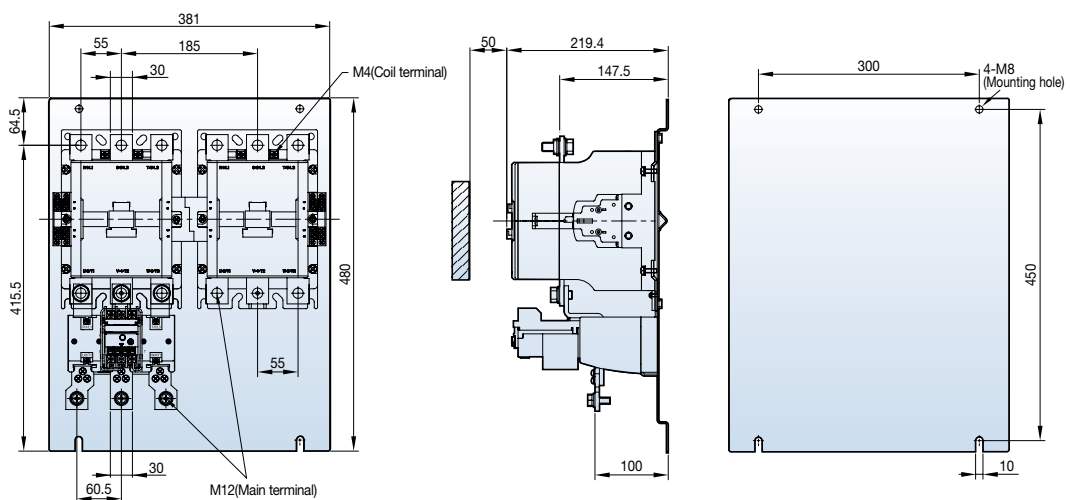

23kg

Contactors relays dimension

[mm]

MR-4 (D)

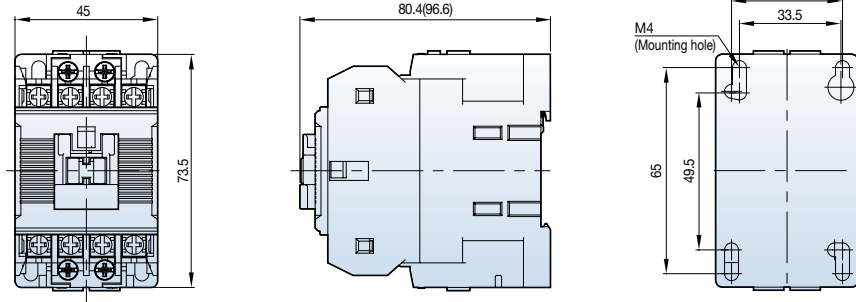

284g

MR-6 (D)

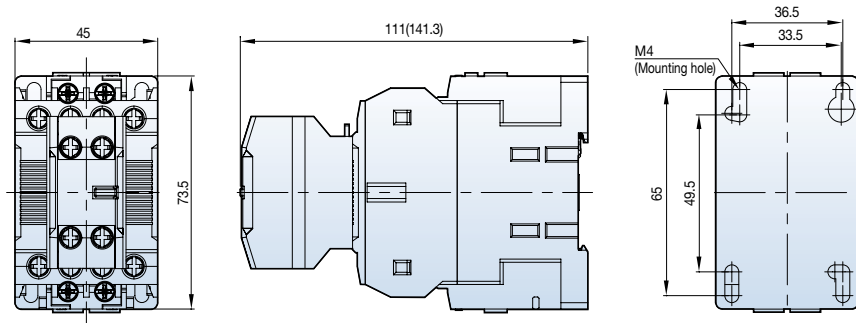

315g

MR-8 (D)

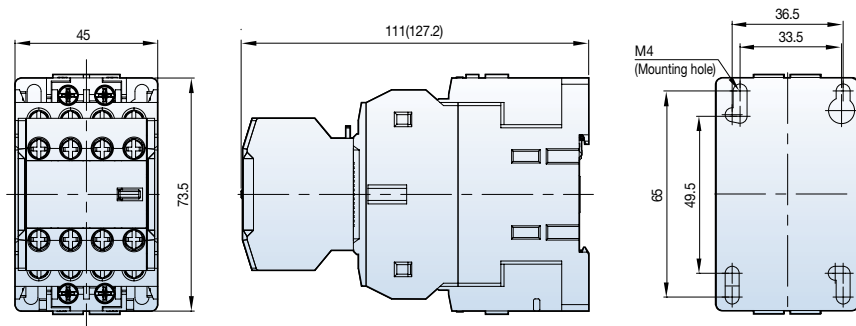

339g

Composition

MR-4	
MR-6	
MR-8	

Note) 1. UA-2: Auxiliary contact units 2. UA-4: Auxiliary contact units
 • Please refer to the contact diagram represented on catalog when contactor relays MR-4, 4D and auxiliary contact units UA-2,4 are purchased separately.
 • Be sure to order the auxiliary contact units separately except for the above contact units. () : Dimension for DC control contactor relays

Latching contactors dimension (18AF/22AF)

MC-6a-18a AC

1NO or 1NC + ML-65

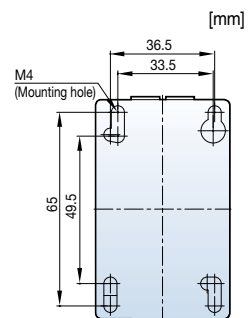
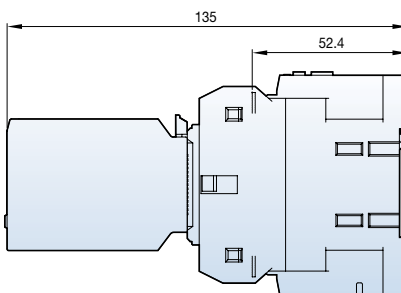
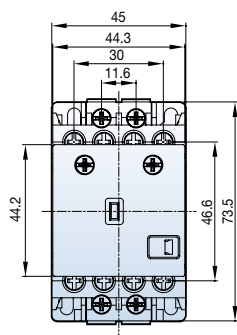

MC-6a-18a DC

1NO or 1NC + ML-65

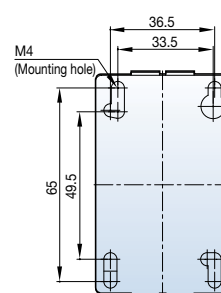
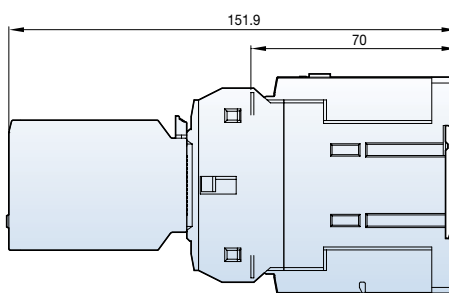
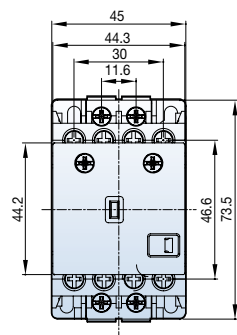

MC-9b-22b AC

1NO1NC + ML-65

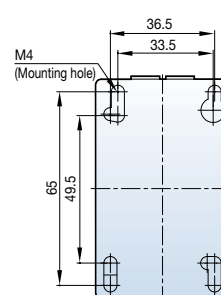
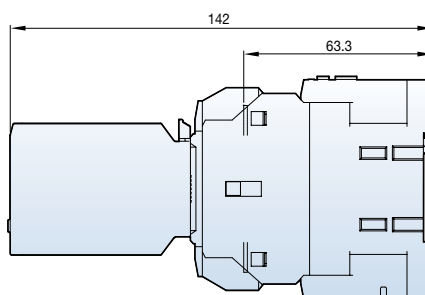
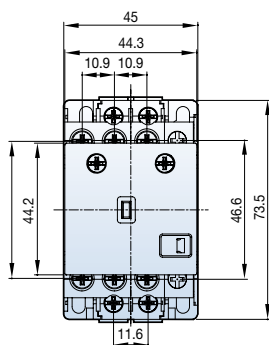

MC-9b-22b DC

1NO1NC + ML-65

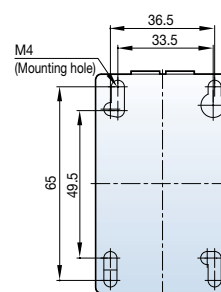
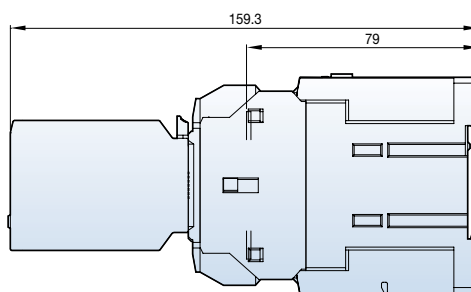
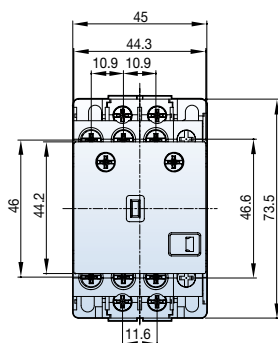

Latching contactors dimension (40AF)

MC-32a-40a AC

+ML-65

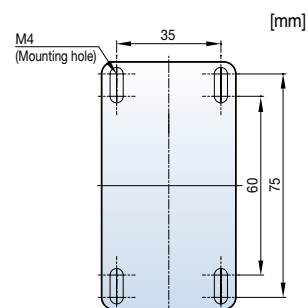
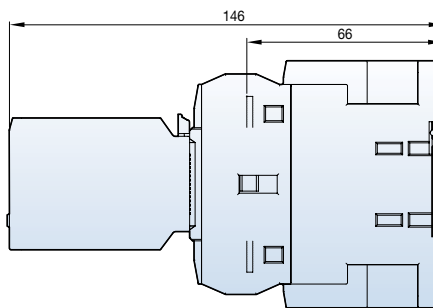
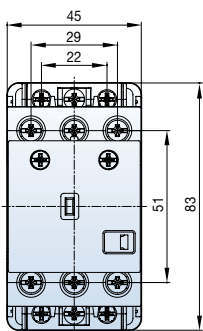

0.5kg

MC-32a-40a DC

+ ML-65

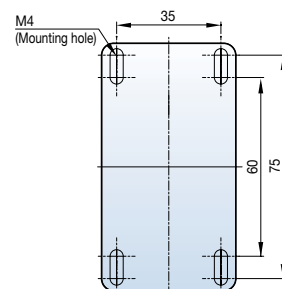
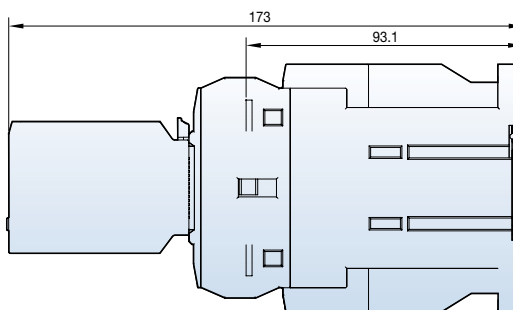
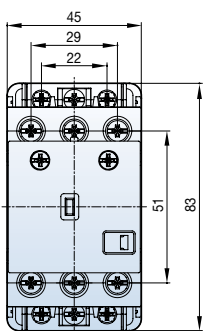

0.8kg

MC-32a-40a AC

2NO2NC + ML-65

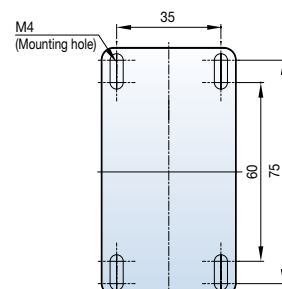
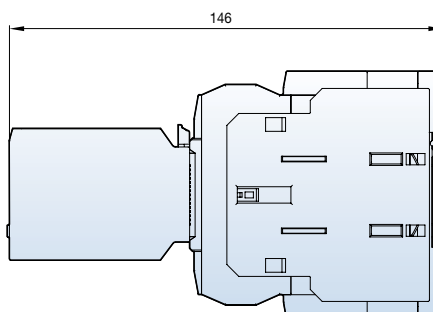
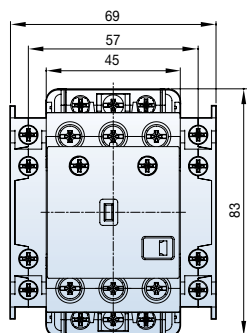

1kg

MC-32a-40a DC

2NO2NC + ML-65

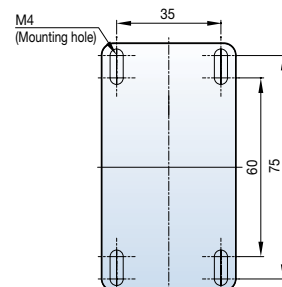
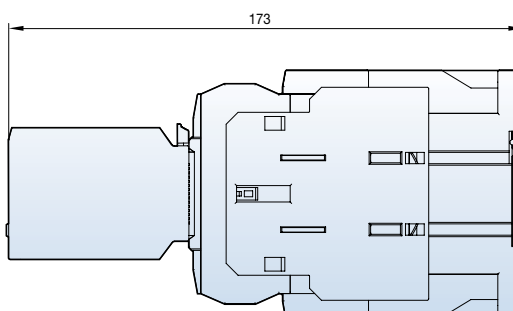
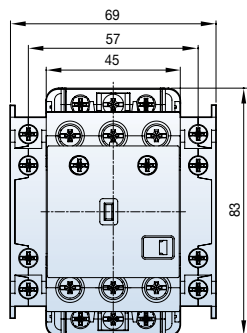

1.3kg

Latching contactors dimension (65AF)

MC-50a-65a AC
+ ML-65

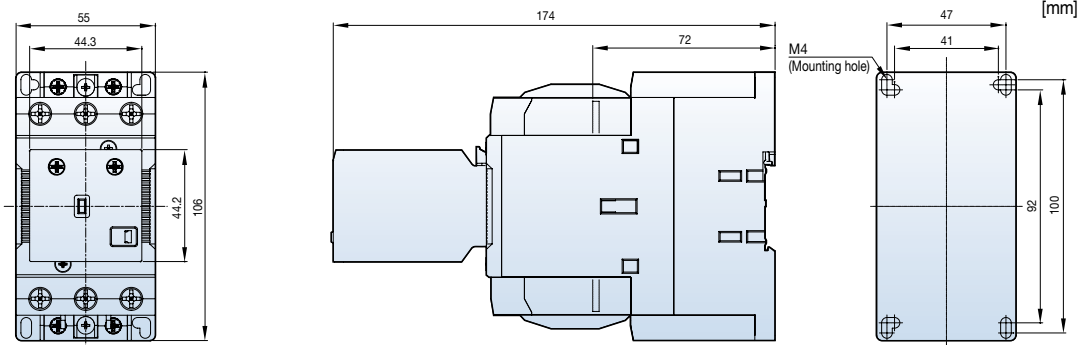

1.9kg

MC-50a-65a DC
+ ML-65

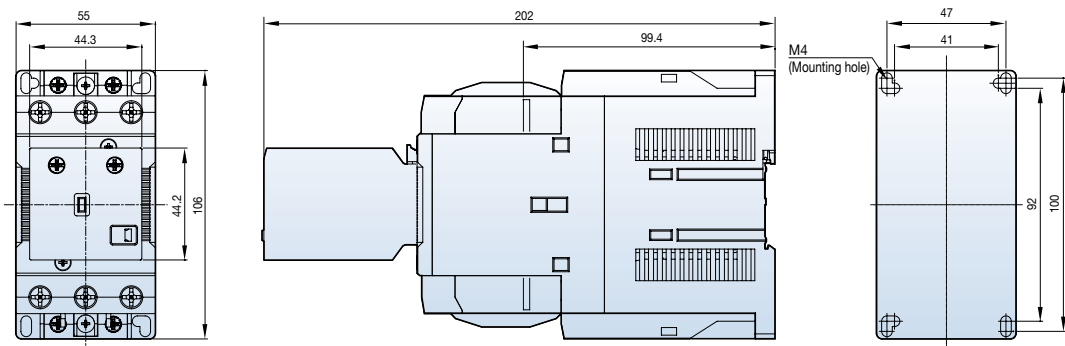

2.8kg

MC-50a-65a AC
2NO2NC + ML-65

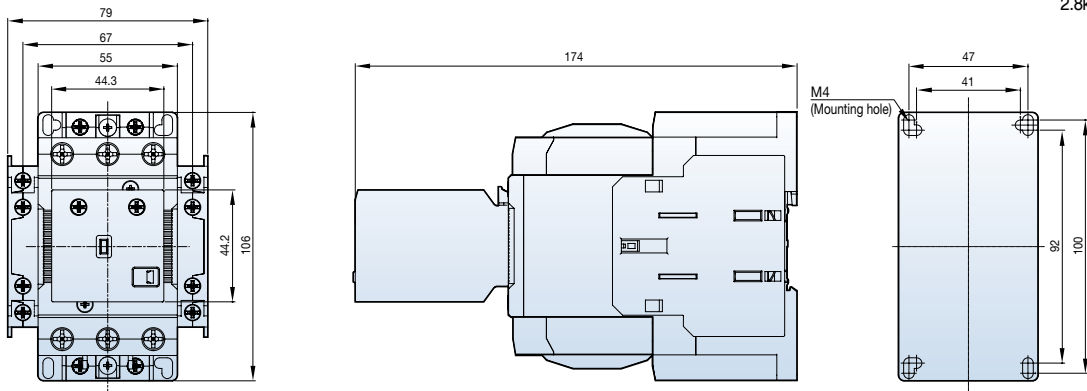

2.4kg

MC-50a-65a DC
2NO2NC + ML-65

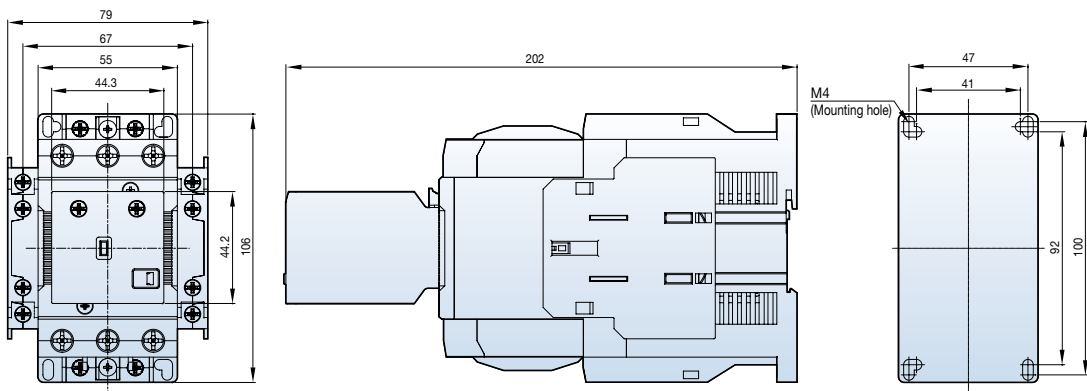

2.4kg

Latching contactors dimension (100AF)

MC-75a~100a AC

+ ML-150

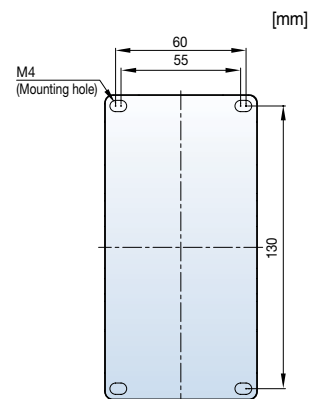
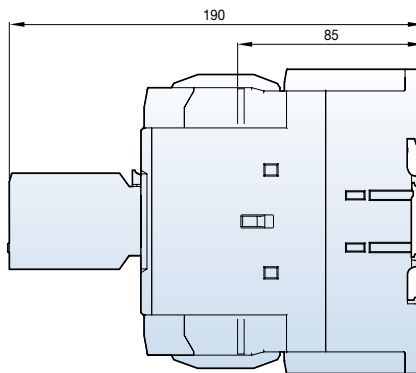
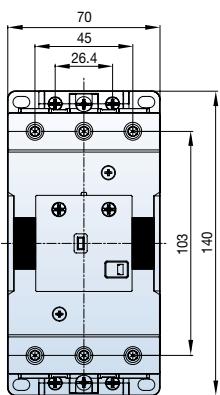

MC-75a~100a DC

+ ML-150

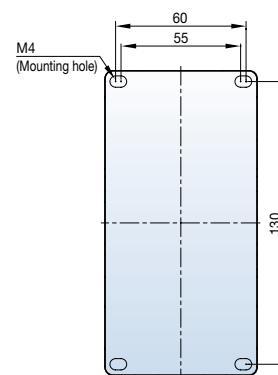
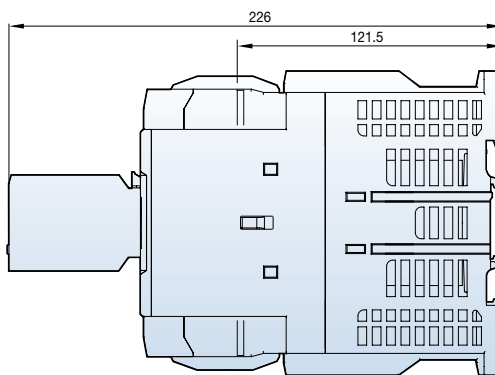
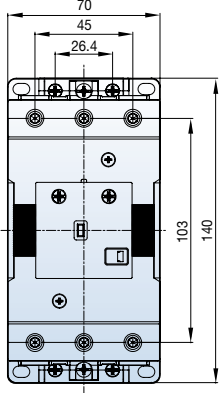

MC-75a~100a AC

2NO2NC + ML-150

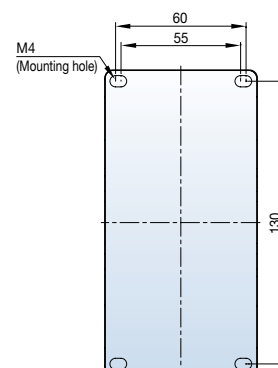
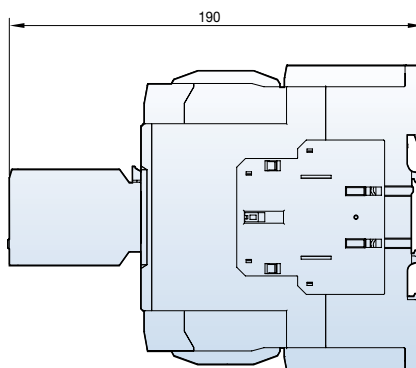
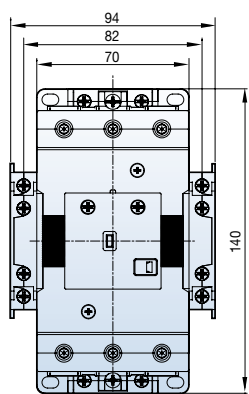

MC-75a~100a DC

2NO2NC + ML-150

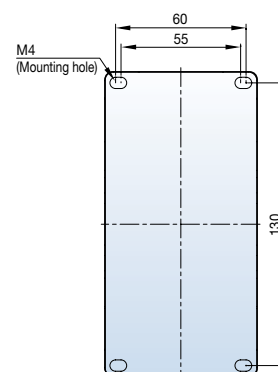
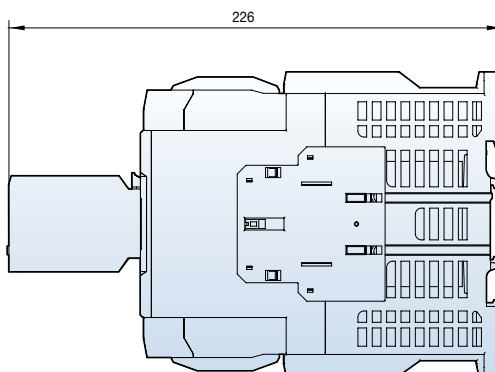
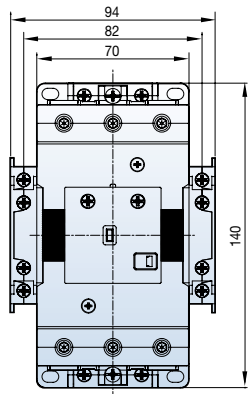

Latching contactors dimension (150AF~400AF)

MC-130a~150a

2NO2NC + ML-150

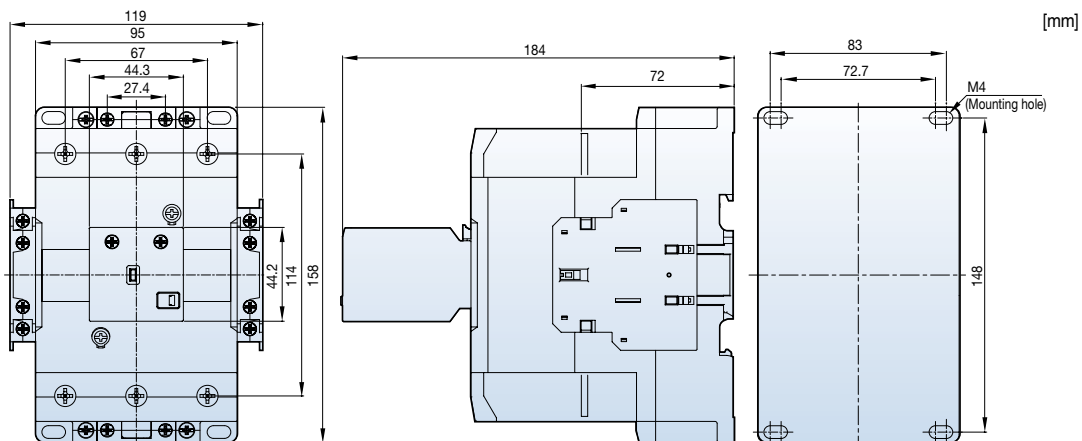

MC-185a

MC-225a

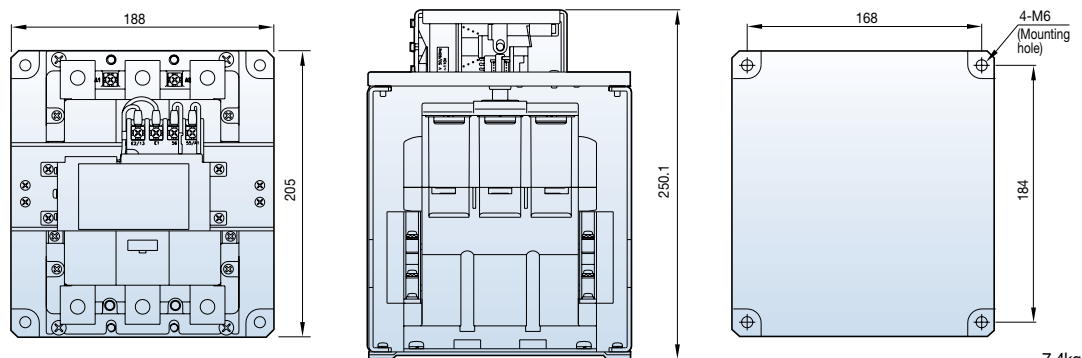

MC-265a

MC-330a

MC-400a

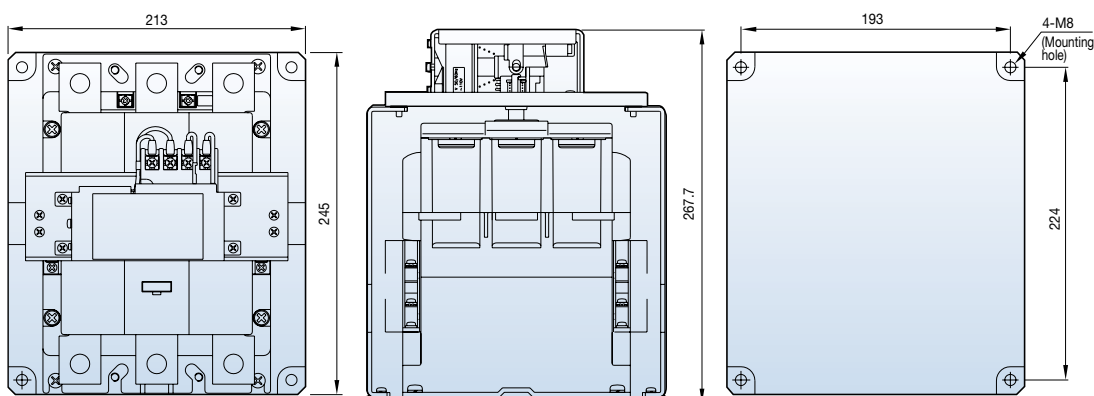

Composition

MC-185a/L~400a/L

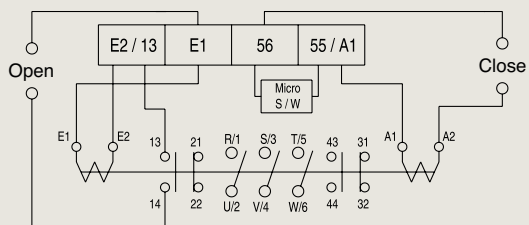

4-pole contactors dimension (MC-6a/4~22a/4)

MC-6a/4~18a/4 AC

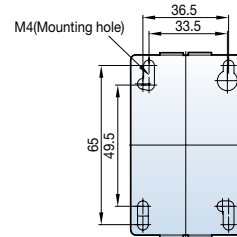
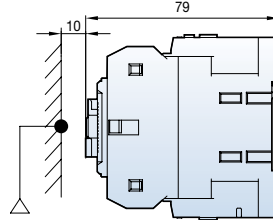
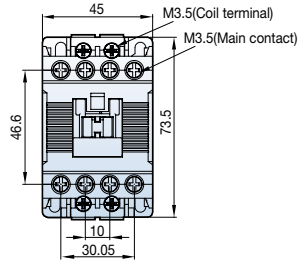

[mm]

0.3kg

MC-6a/4~18a/4 DC

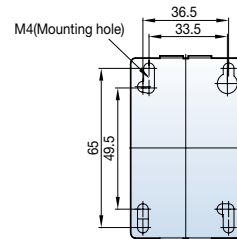
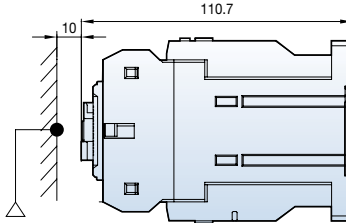
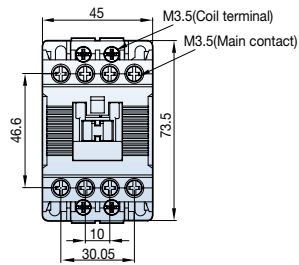

0.45kg

MC-22a/4 AC

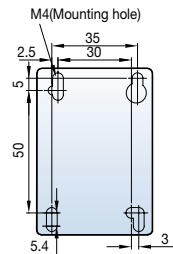
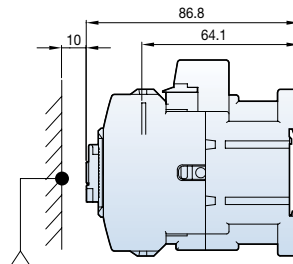
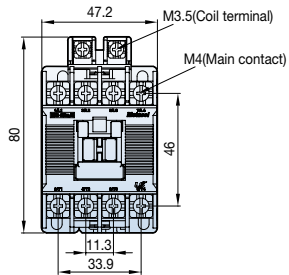

0.4kg

MC-22a/4 DC

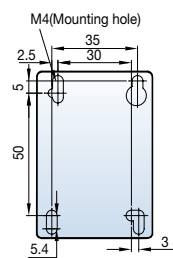
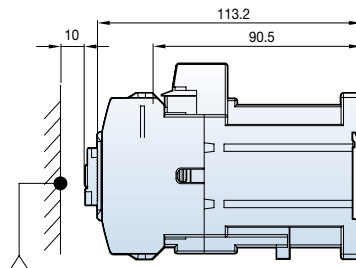
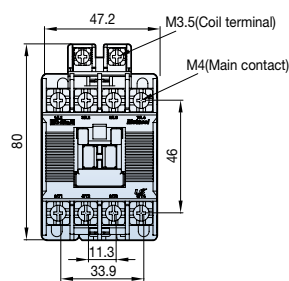

0.5kg

4-pole contactors dimension (MC-32a/4~85a/4)

MC-32a/4~40a/4 AC

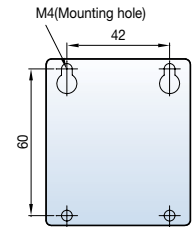
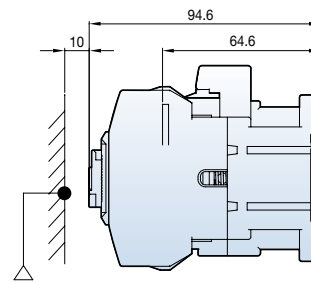
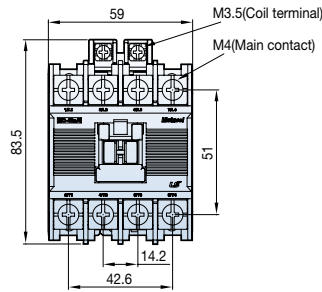

[mm]

0.59kg

MC-32a/4~40a/4 DC

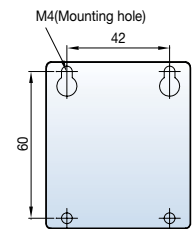
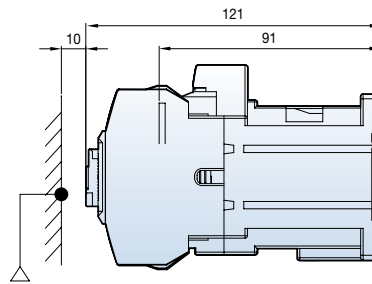
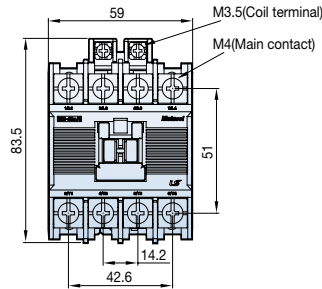

0.7kg

MC-50a/4~85a/4 AC

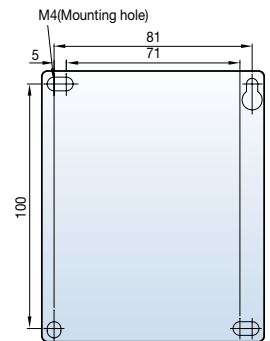
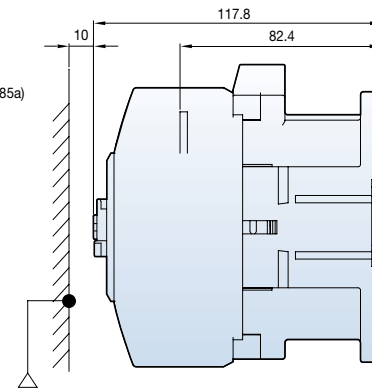
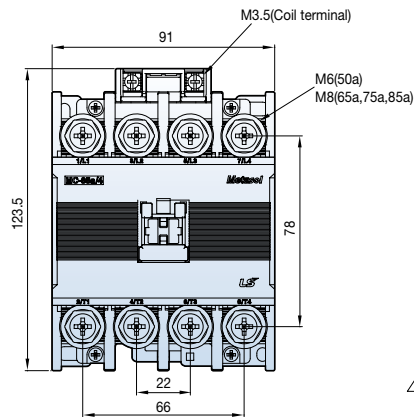

1.2kg

MC-50a/4~85a/4 DC

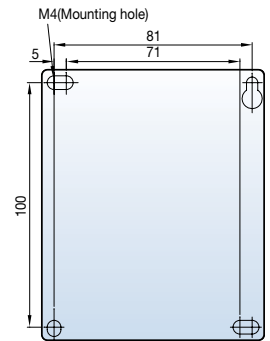
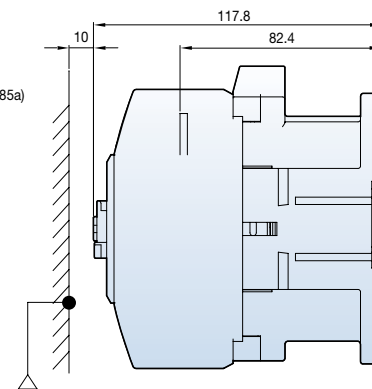
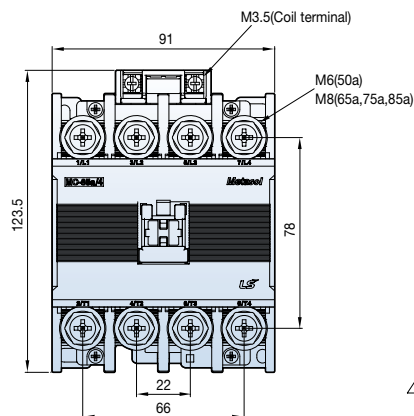

4-pole contactors dimension (MC-100a/4~800a/4)

[mm]

- MC-100a/4
- MC-130a/4
- MC-150a/4
- MC-185a/4
- MC-225a/4

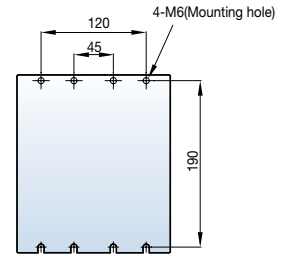
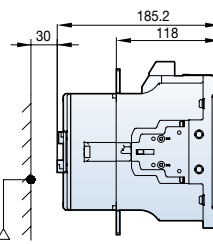
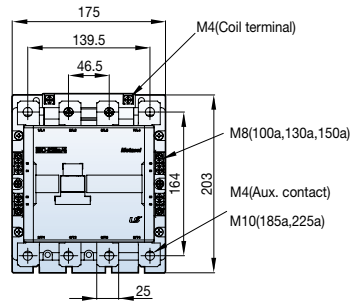

5.6kg

- MC-265a/4
- MC-330a/4
- MC-400a/4

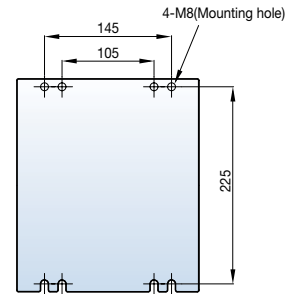
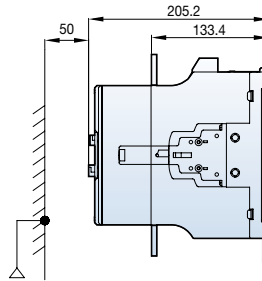
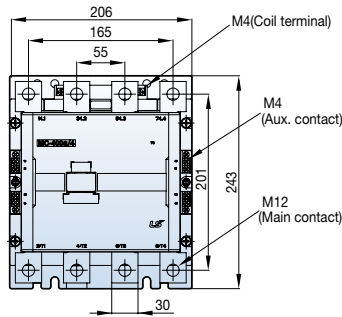

9.9kg

- MC-500a/4
- MC-630a/4
- MC-800a/4

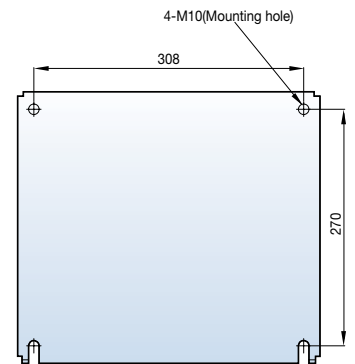
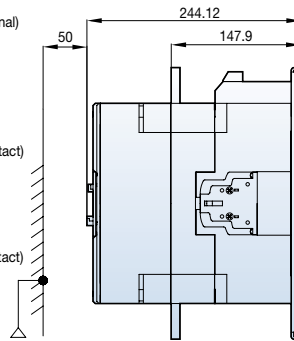
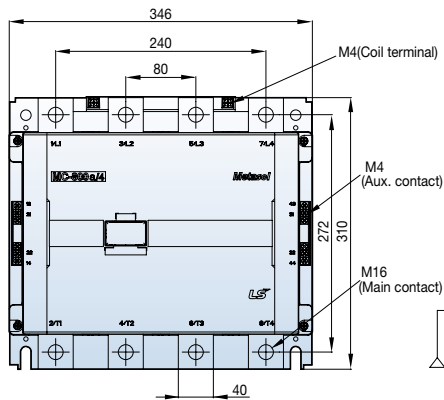

26.3kg

Enclosed motor starters, Mold enclosure dimension

MW-9bM~22bM

[mm]

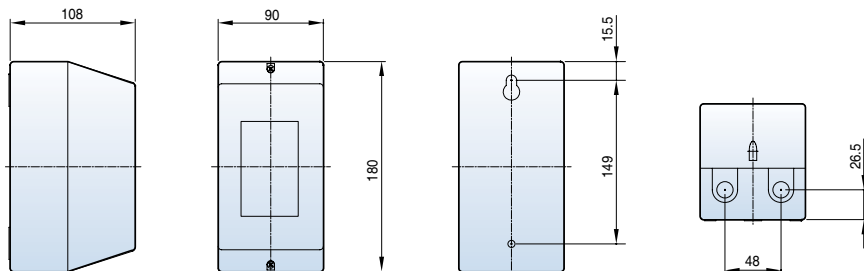

0.8kg

MW-9bMB~22bMB

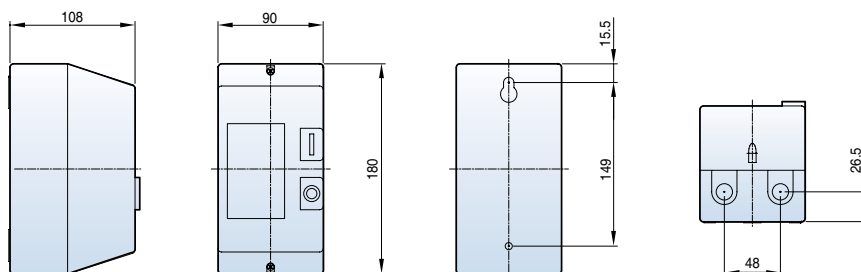

0.8kg

Circuit diagram

MW-9bM~22bM

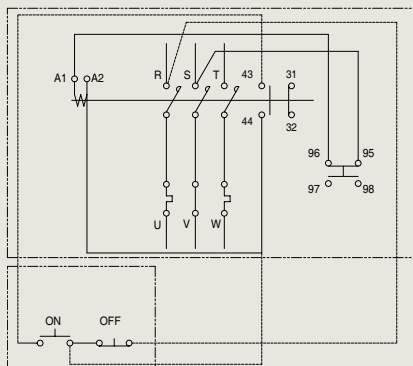

MW-9bMB~22bMB

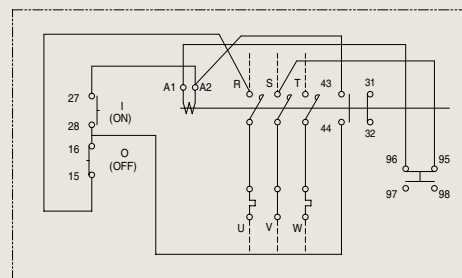

Enclosed motor starters, Steel enclosure dimension

[mm]

- MW-6a~100a
- MW-9b~22b

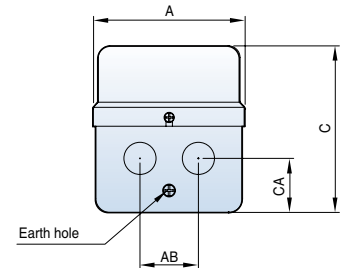
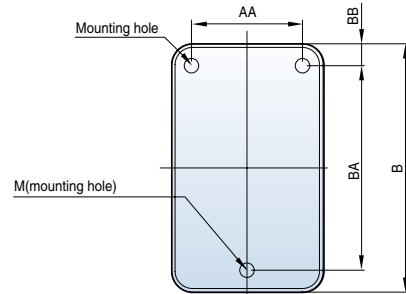

Type	A	AA	AB	B	BA	BB	C	CA	M	N	Weight(kg)
MW-9b~22b, 6a~18a	104	76	40	170	140	15	114	41	M5	Ø22	1.1
MW-32a, 40a	145	95	55	245	165	40	130	50	M5	Ø35	1.6
MW-50a, 65a	160	120	74	290	220	35	141	50	M5	Ø35	2.7
MW-75a, 85a, 100a	160	120	74	290	220	35	161	67	M5	Ø35	3.6

Circuit diagram

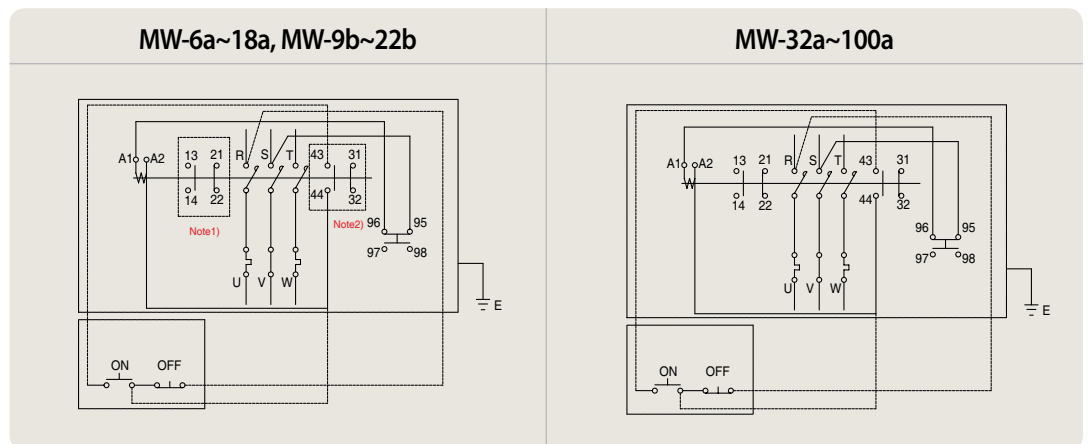

Note) 1. In case of adding the auxiliary contact unit(1NO1NC).
 2. See below for MC-6a~18a(1NO)



Enclosed motor starters, Steel enclosure dimension

MW-6aB~100aB

MW-9bB~22bB

[mm]

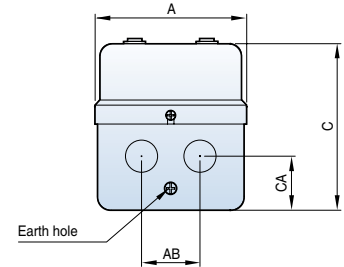
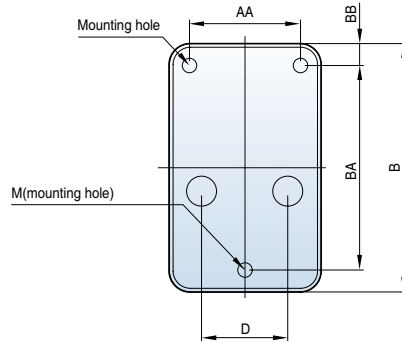

Type	A	AA	AB	B	BA	BB	C	CA	D	M	N	Weight(kg)
MW-9bB~22bB, 6aB~18aB	104	76	40	170	140	15	114	41	59	M5	Ø22	1.1
MW-32aB, 40aB	145	95	55	245	165	40	130	50	97	M5	Ø35	1.6
MW-50aB, 65aB	160	120	74	290	220	35	141	50	114	M5	Ø35	2.7
MW-75aB, 85aB, 100aB	160	120	74	290	220	35	161	67	114	M5	Ø35	3.6

Circuit diagram

MW-6aB~18aB, MW-9bB~22bB

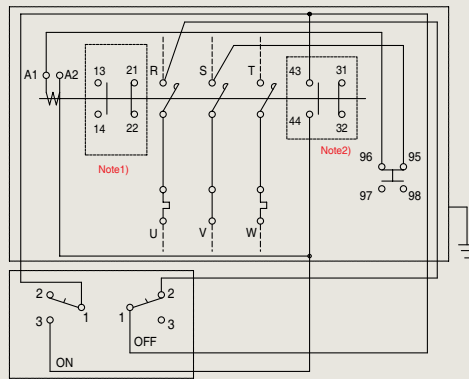

MW-32aB~100aB

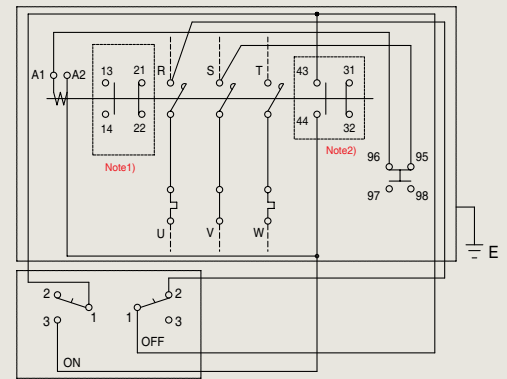

Note) 1. In case of adding the auxiliary contact unit(1NO1NC).
 2. See below for MC-6a~18a(1NO)



Capacitor contactors (MC-9b~40a with AC-9, MC 50a~100a with AC-50)

[mm]

MC-9b~22b
with AC-9

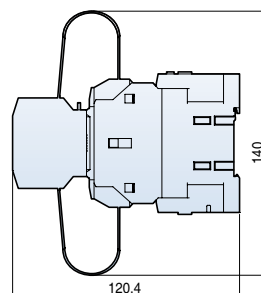
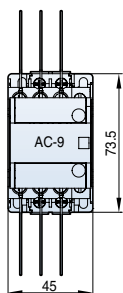

MC-32a,40a
with AC-9

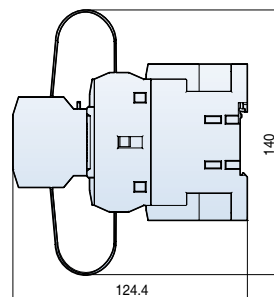
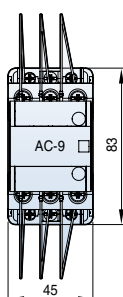

MC-50a,65a
with AC-50

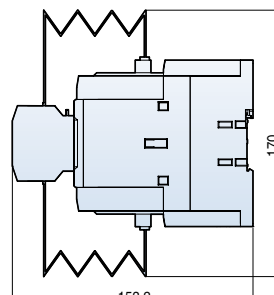
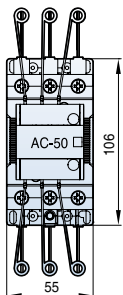

MC-75a~100a
with AC-50

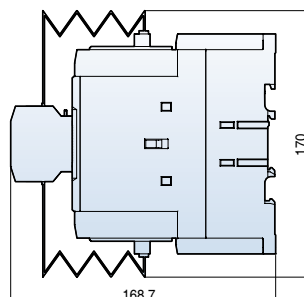
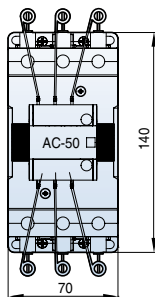

Circuit diagram

MC-9b~22b with AC-9

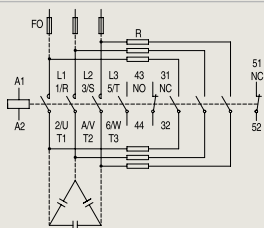

MC-32a, 40a with AC-9 MC 50a~100a with AC-50

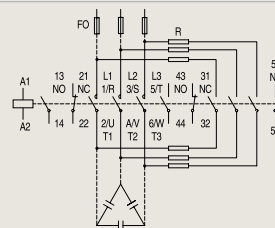

2-pole AC Contactors dimension (GMC-10P2~40P2)

- GMC-10P2
- GMC-20P2
- GMC-25P2
- GMC-30P2
- GMC-35P2
- GMC-40P2
- (TSBS Type)

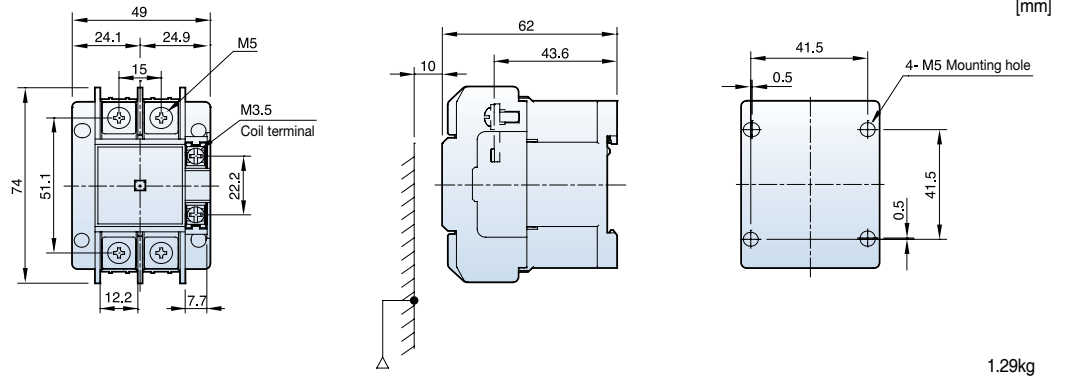

- GMC-10P2
- GMC-20P2
- GMC-25P2
- GMC-30P2
- GMC-35P2
- GMC-40P2
- (TQBS Type)

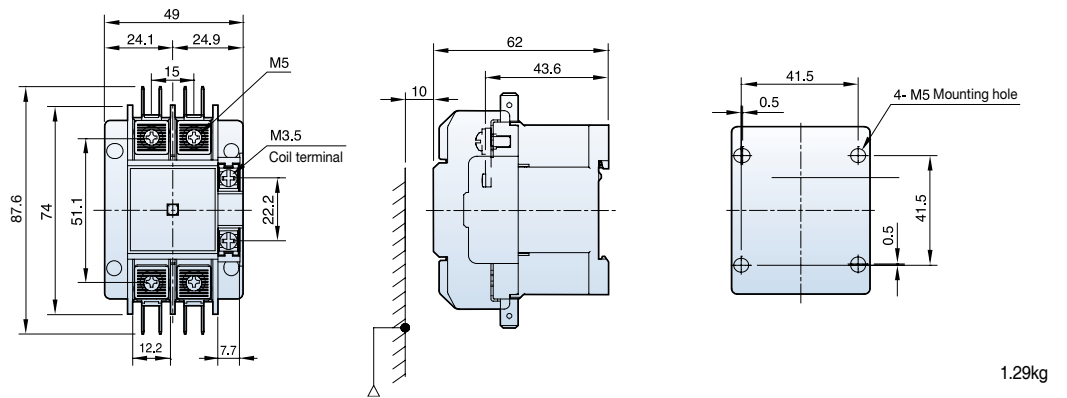

Composition

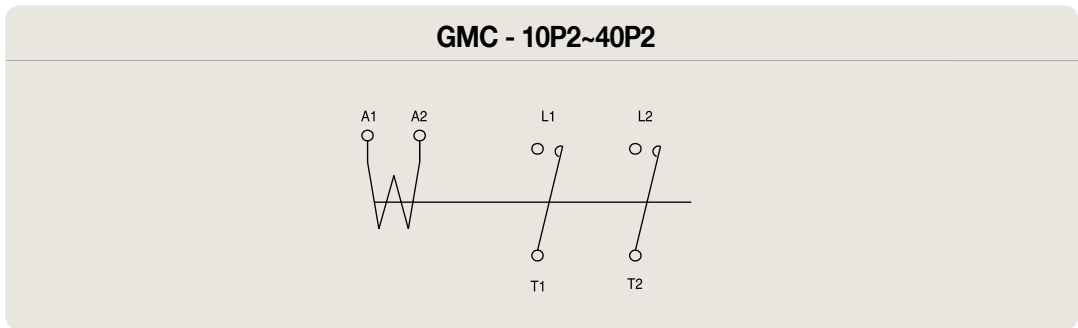

Terminal

Type	Terminals	Screw	Wire (mm ²)	Torque (kgf · cm)	A×B×C (mm)
GMC-10P2~40P2	Main	M5	1-16	26	12.2×7×8
	Coil	M3.5	1-2.5	12	7.7×7.5×4.5

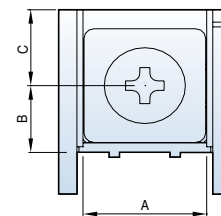

3-pole AC Contactors dimension (GMC-20D, 25D)

GMC-20D
GMC-25D

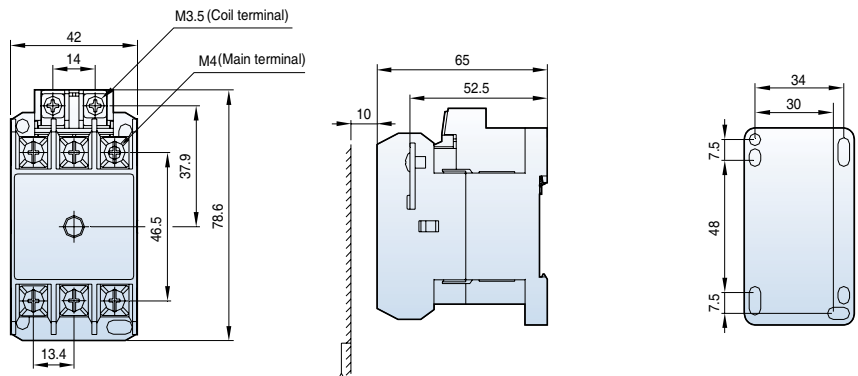

[mm]

Contact arrangement

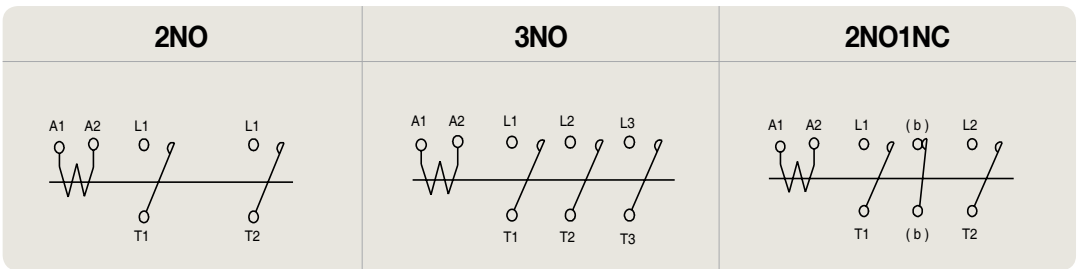

Terminal

Type	Screw	Wire (mm ²)	Torque (kgf · cm)	A × B × C (mm)
GMC-20D~25D	M4	1-10	15	9.4 × 5 × 85.1
Coil~	M3.5	1.25~2	12	8 × 5 × 4.9

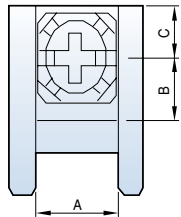

Single-pole AC Contactors (MC-65aSP)

MC-65aSP

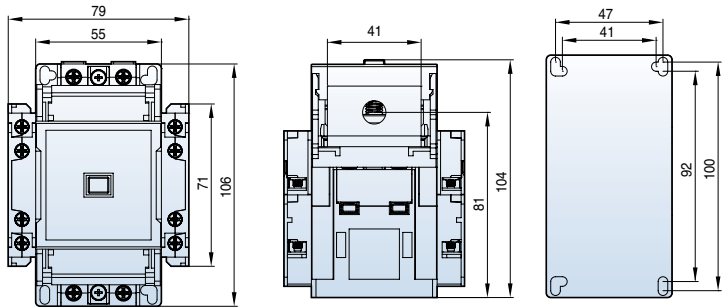

Composition

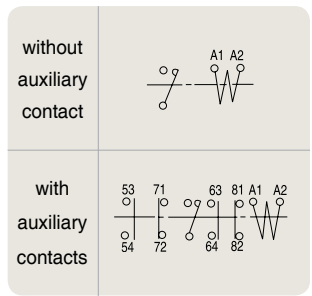

0.65kg

DC Contactors dimension (MD-30a, 60a,100a)

MD-30a AC(DC)

2NO2NC

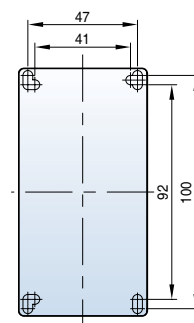
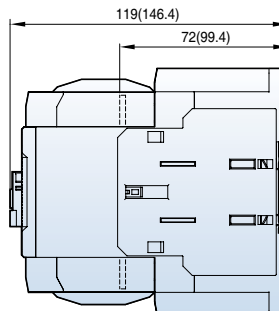
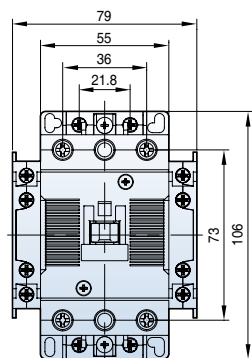

[mm]

MD-60a,100a AC(DC)

2NO2NC

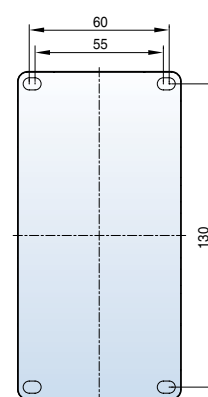
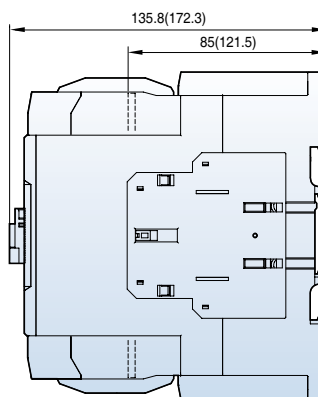
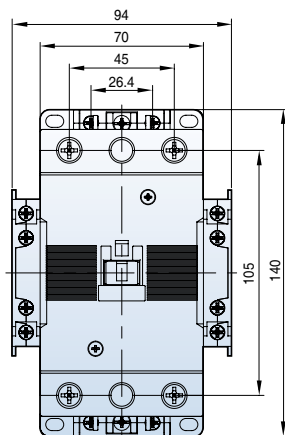

Composition

MD-30a, 60a, 100a

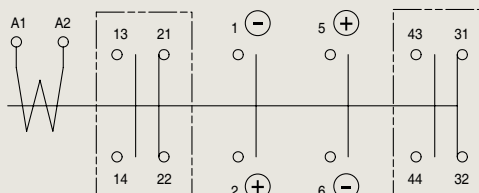

Contact arrangement

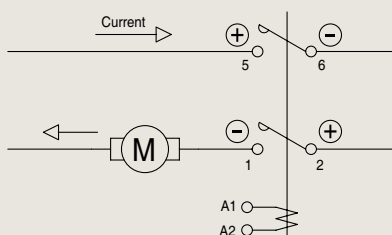

Overload relays dimension

MT-12

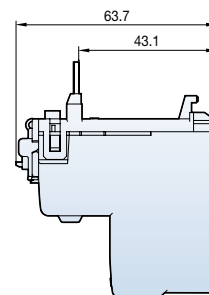
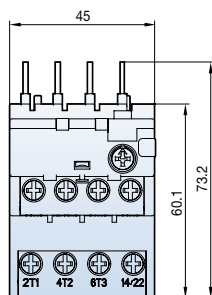

[mm]

100g

MT-32

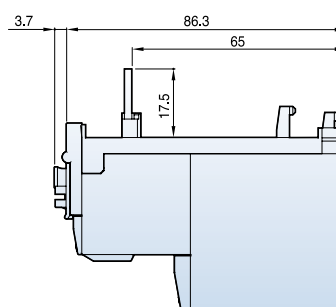
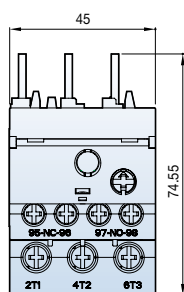

167g

MT-63

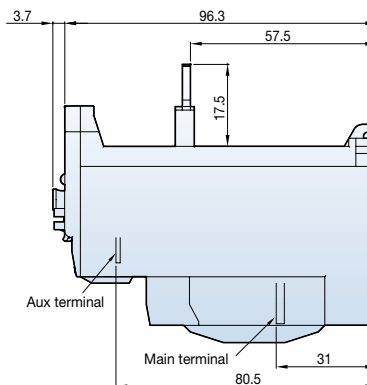
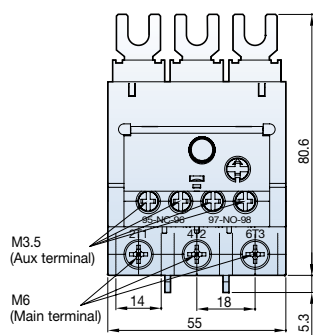

303g

MT-95

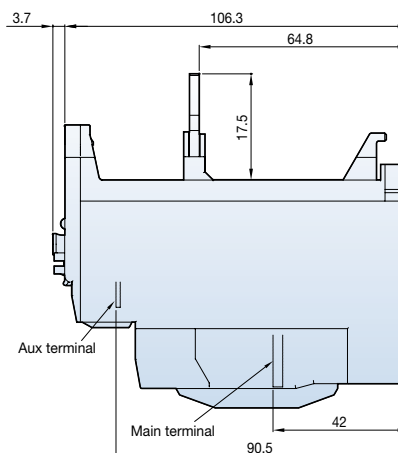
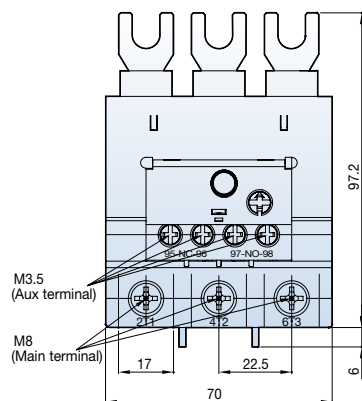

474g

Overload relays dimension

MT-150

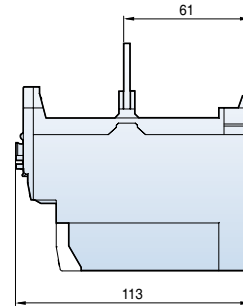
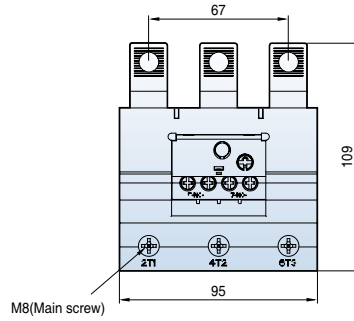

[mm]

0.7kg

MT-225

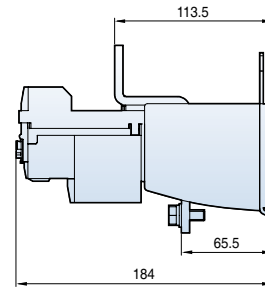
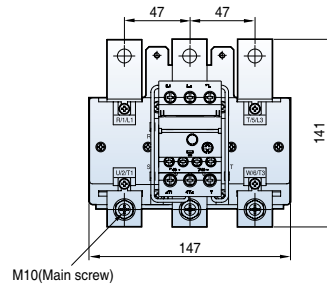

2.5kg

MT-400

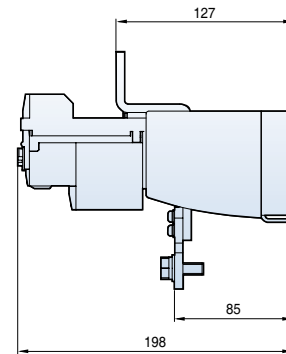
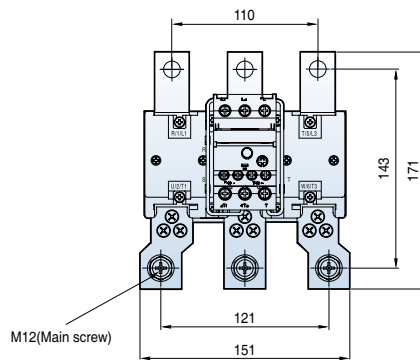

2.6kg

MT-800

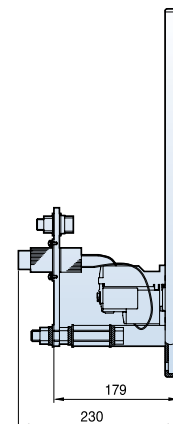
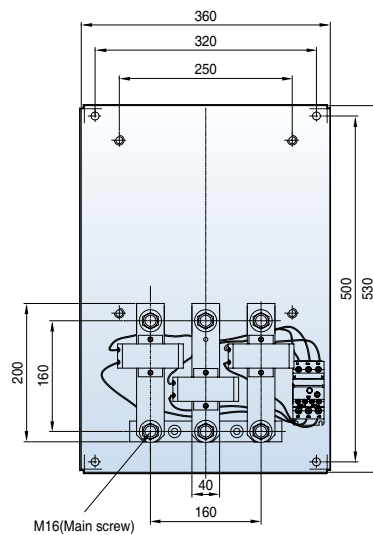

11.5kg

Overload relays dimension (Separate mount)

UZ-12

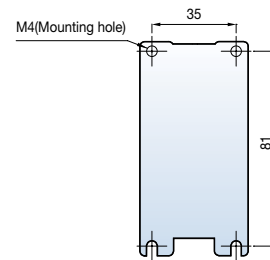
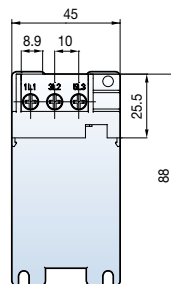
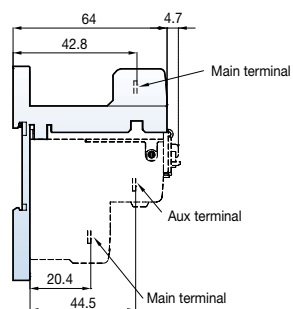

[mm]

35g

UZ-32

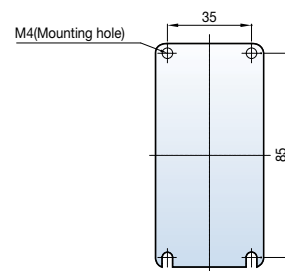
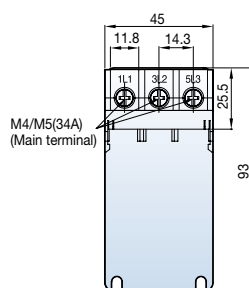
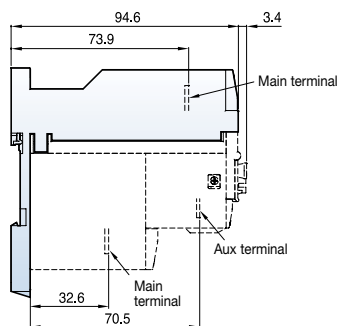

68g

UZ-63

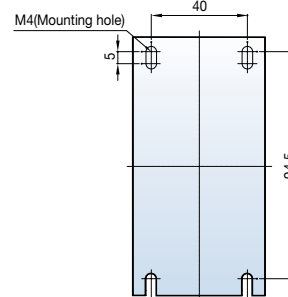
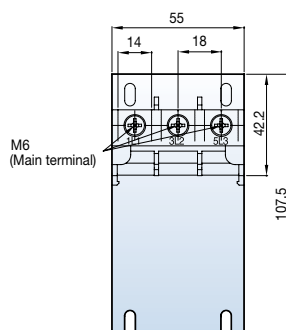
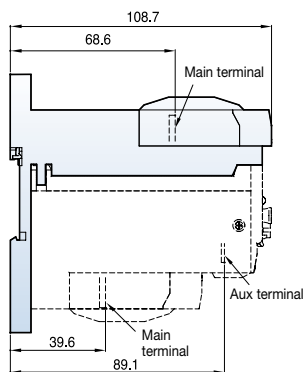

134g

Overload relays dimension (Separate mount)

UZ-95

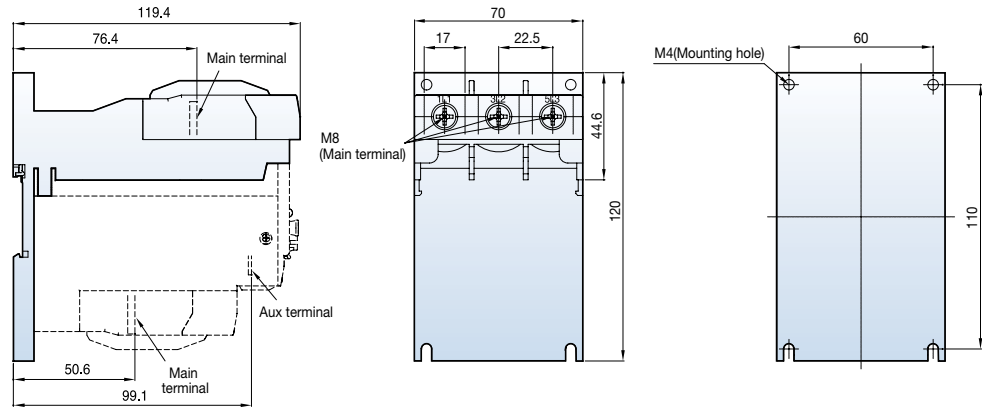

[mm]

230g

UZ-150

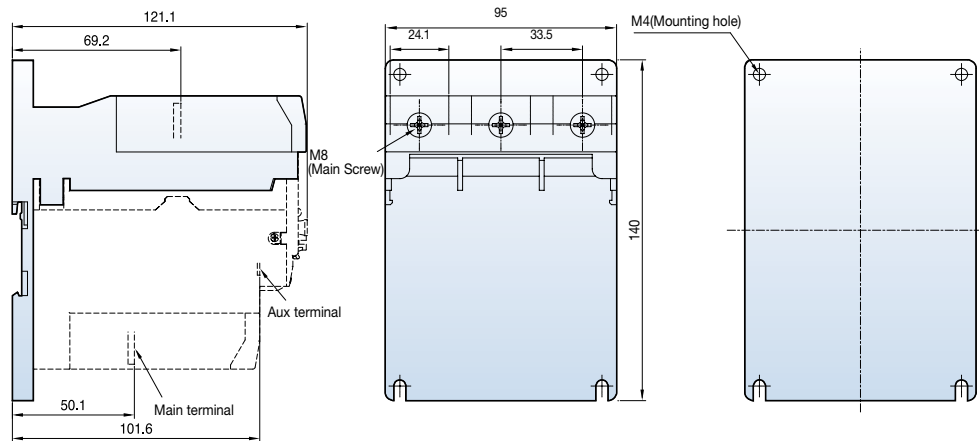

284g

외형 및 부착치수

AD - 9

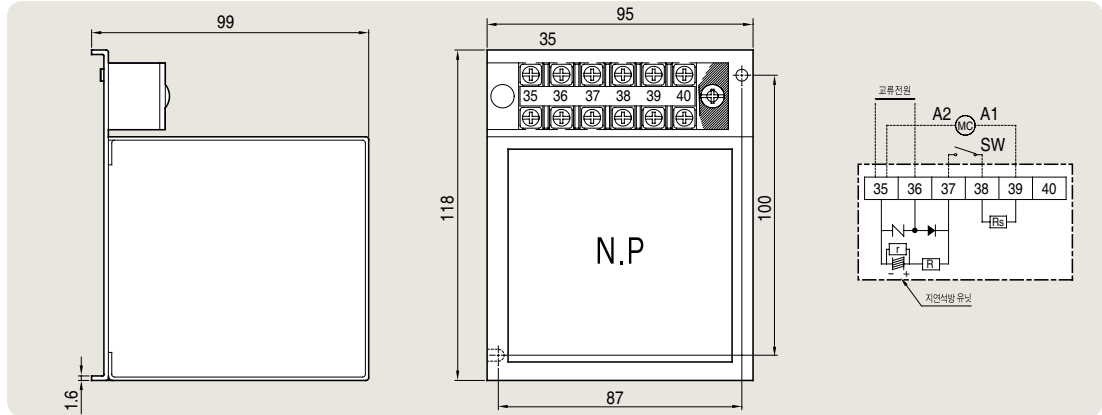

AD - 50

AD - 100

AD - 300

AD - 600

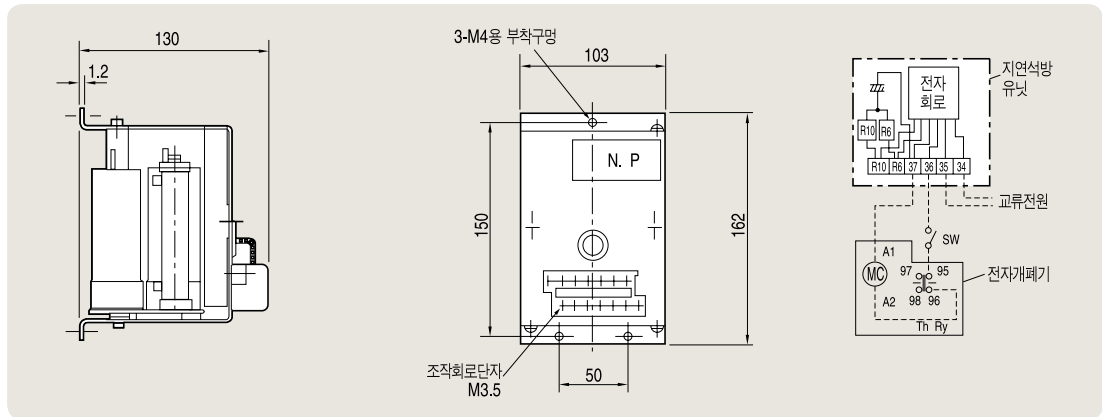

0.5kg

동작설명

AD - 9

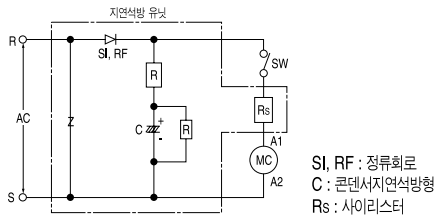

교류전원은 정류회로 SI, RF를 통해 직류로 정류되어 전자접촉기의 코일 MC에 병렬로 접속된 콘덴서 C를 충전시킵니다.

푸시버튼스위치 On을 누르면, 전자코일 MC가 여자되어 접촉기가 투입되며, 순간정전시는 콘덴서 C의 방전전류가 전자코일에 흘러 일정시간 접촉기의 석방을 지연시키게 됩니다. 또한 인위적으로 접촉을 개로시킬 때(푸시버튼 스위치를 조작)나 열동형 과부하계전기가 동작할 경우는 접촉기가 지연석방 유닛과 관계없이 석방됩니다.

※ 본 제품의 ON-OFF 스위치는 그림과 같이 직류측에 설치하여 주십시오. 교류측에서 ON-OFF를 하면 접촉기가 Chattering현상이 일어나므로 주의바랍니다.

AD - 50~600

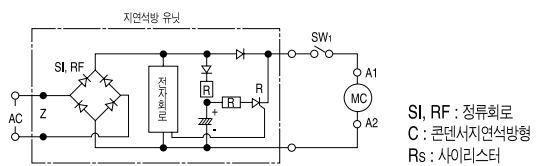

교류전원은 정류회로 SI, RF를 통해 직류로 정류되어 전자접촉기의 코일 MC에 병렬로 접속된 콘덴서 C를 충전시킵니다. SW 1을 On하면 정류된 직류가 전자접촉기의 코일에 직접 흘러 전자접촉기가 투입됩니다.

순시정전시에는 지연석방 유닛에 부착되어 있는 전자회로에 의해 사이리스터 Q가 On(통전)상태로 되어 사이리스터 Q를 통해 콘덴서의 방전전류가 전자 코일에 흘러 일정 시간 접촉기의 석방을 지연시키게 됩니다. 또한 인위적으로 접촉을 개로시킬 때(푸시버튼스위치를 조작)나 열동형 과부하계전기가 동작할 경우에는 접촉기가 지연석방 유닛과 관계없이 석방됩니다.

※ 본 제품의 On-Off 스위치는 그림과 같이 직류측에 설치하여 주십시오.

Electronic timer unit

ON delay timer

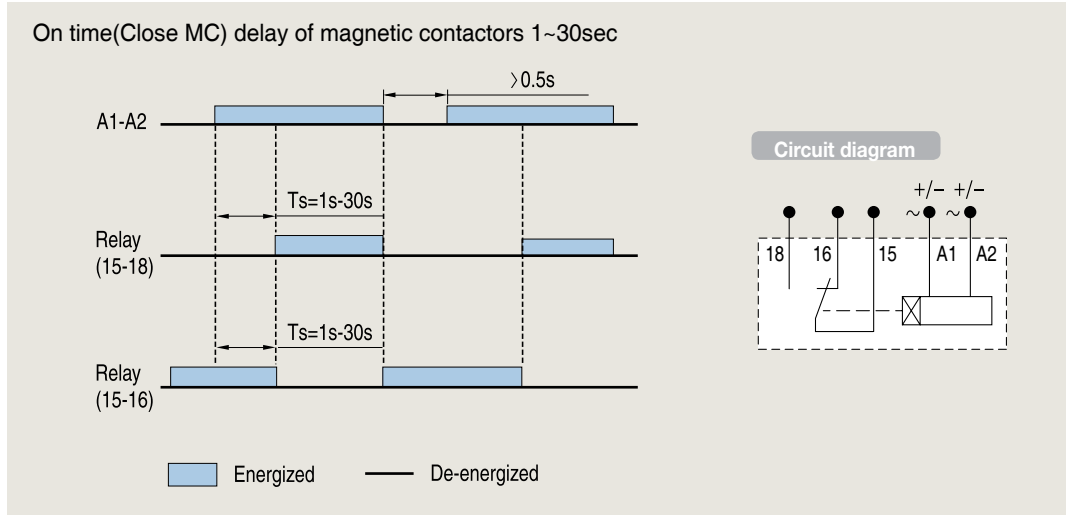

OFF delay timer

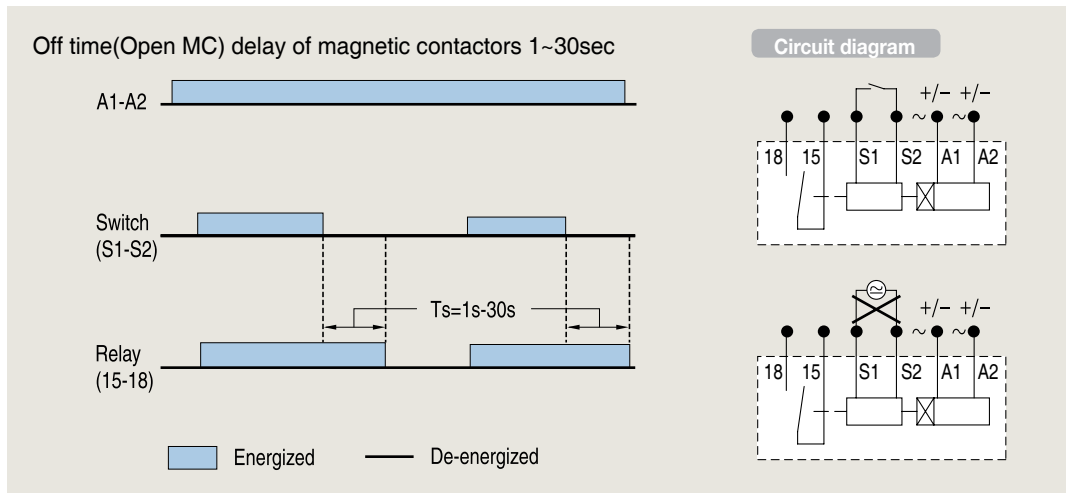

Dimension

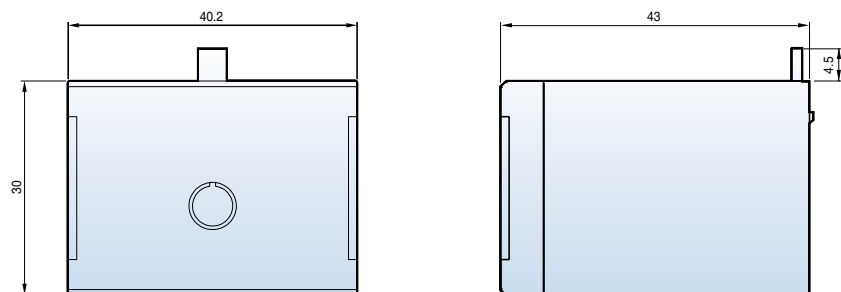

Contact arrangement

Contactors

MC-6a~18a

1NO



1NC

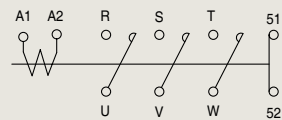

MC-9b~22b

1NO1NC

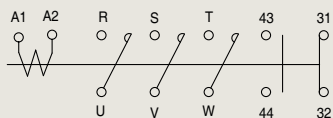

MC-32a~150a

2NO2NC

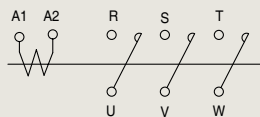
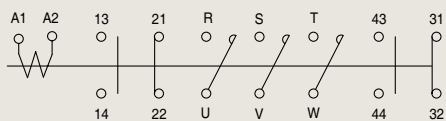

Contact arrangement

Motor starters

MS-6a~150a

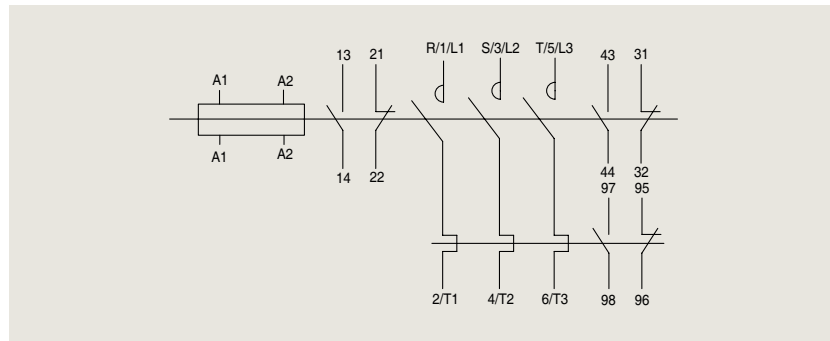
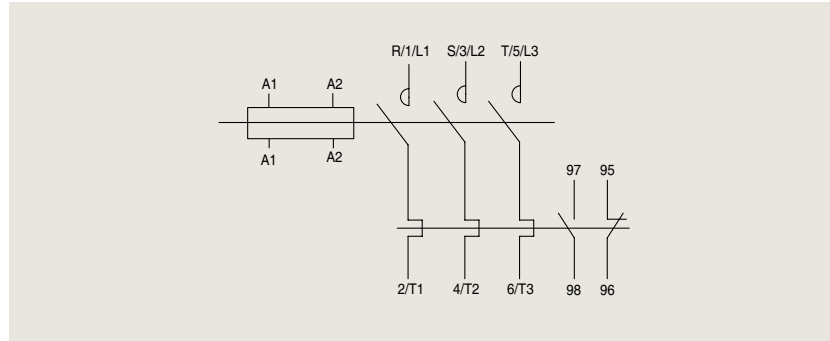

MS-185a~800a

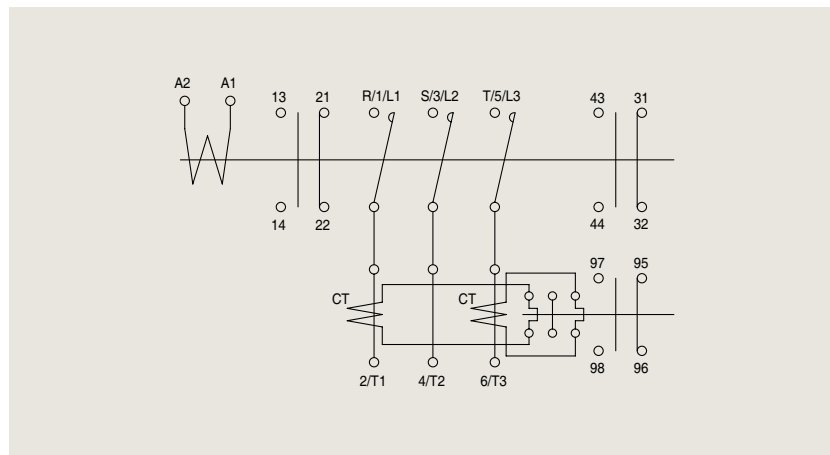

Reversing contactors

MC-6aR~150aR

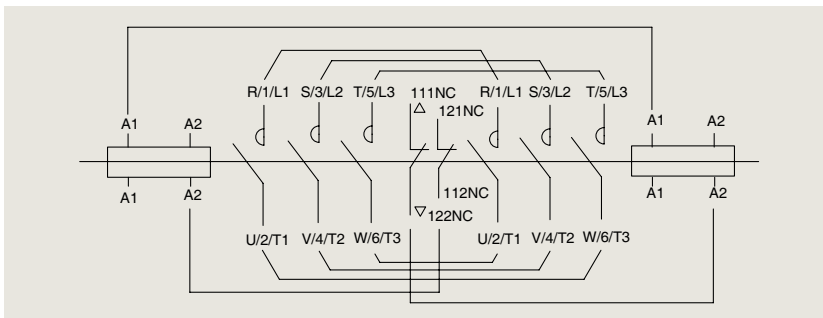

MC-185aR~800aR

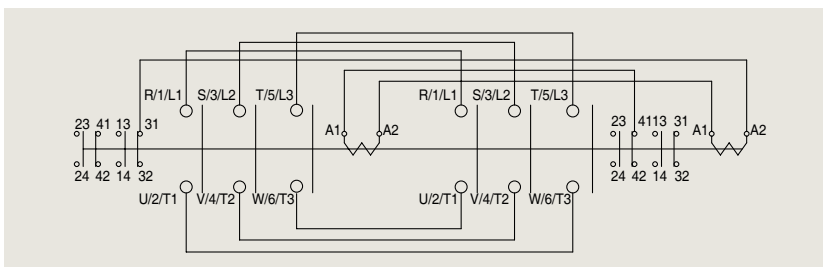

MS-6aR~150aR

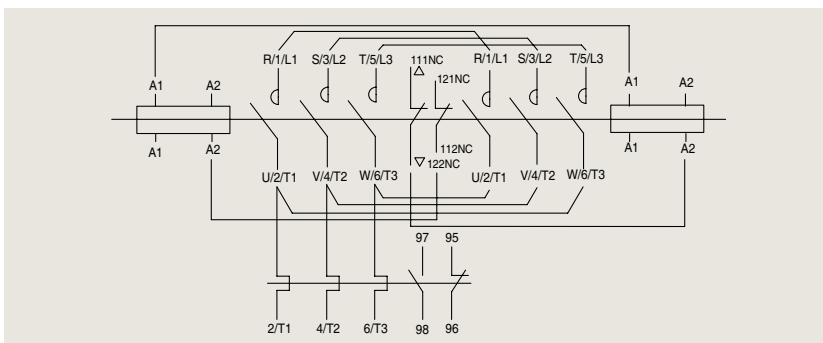

MS-185aR~400aR

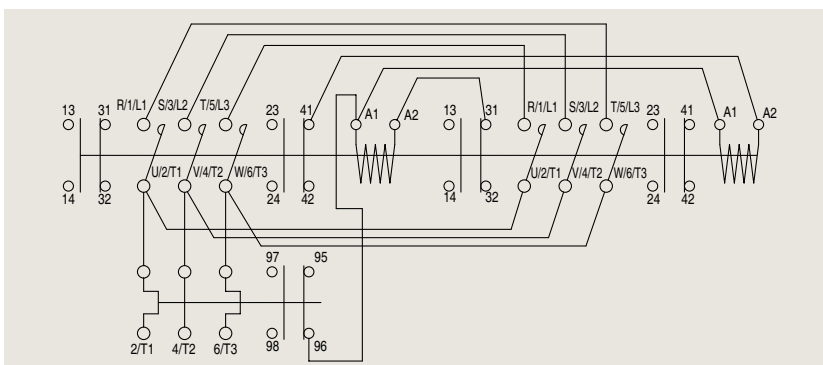

Meta-MEC and Metasol MC comparison table

		Type	MC-6a	MC-9a	MC-12a	MC-18a	MC-9b	MC-12b	MC-18b	MC-22b	MC-32a	MC-40a	MC-50a	MC-65a	
Manufactured products	Metasol MC	Current and power AC3	200~240V 2.2kW 9A	2.5kW 11A	3.5kW 13A	4.5kW 18A	2.5kW 11A	3.5kW 13A	4.5kW 18A	5.5kW 22A	7.5kW 32A	11kW 40A	15kW 55A	18.5kW 65A	
			380~440V 3kW 7A	4kW 9A	5.5kW 12A	7.5kW 18A	4kW 9A	5.5kW 12A	7.5kW 18A	11kW 22A	15kW 32A	18.5kW 40A	22kW 50A	30kW 65A	
			500~550V 3kW 6A	4kW 7A	7.5kW 12A	7.5kW 13A	4kW 7A	7.5kW 12A	7.5kW 13A	15kW 20A	18.5kW 28A	22kW 32A	30kW 43A	33kW 60A	
		Auxiliary (Standard)	1NO or 1NC				1NO1NC				-		-		
		Mounting size													
		Weight (kg)	0.33				0.34				0.4		0.9		
		Demension (W×H×D)	45 × 73.5 × 80.4				45 × 73.5 × 87.4				45 × 83 × 90		55 × 106 × 119		
Discontinued products	Meta-MEC MC	Current and power AC3	-				GMC-9	GMC-12	GMC-18	GMC-22	GMC-32	GMC-40	GMC-50	GMC-65	
			200~220V	-				2.5kW 11A	3.5kW 13A	4.5kW 18A	5.5kW 22A	7.5kW 32A	11kW 40A	15kW 55A	18.5kW 65A
			380~440V	-				4kW 9A	5.5kW 12A	7.5kW 18A	11kW 22A	15kW 32A	18.5kW 40A	22kW 50A	30kW 65A
		500~550V	-				4kW 7A	7.5kW 12A	15kW 13A	18.5kW 22A	22kW 28A	30kW 32A	33kW 43A	60A	
		Auxiliary (Standard)	-				1NO1NC	1NO1NC	1NO1NC	1NO1NC	2NO2NC	2NO2NC	2NO2NC	2NO2NC	
		Mounting size	-												
		Weight (kg)	-				0.33		0.37		0.45		1		
	Demension (W×H×D)	-				44 × 80 × 86.8				68 × 82 × 94.6		94 × 122 × 115.7			
	Compatibility with Metasol	-				○				▲		▲			

Note) Marks of compatibility
 ○: can be compatible
 ▲: compatible when applied the bracket
 ×: can't be compatible(have to use bracket)

MC-75a	MC-85a	MC-100a	MC-130a	MC-150a	MC-185a	MC-225a	MC-265a	MC-330a	MC-400a	MC-500a	MC-630a	MC-800a
22 kW 75A	25kW 85A	30kW 105A	37kW 130A	45kW 150A	55kW 185A	75kW 225A	80kW 265A	90kW 330A	125kW 400A	147kW 500A	190kW 630A	220kW 800A
37 kW 75A	45kW 85A	55kW 105A	60kW 130A	75kW 150A	90kW 185A	132kW 225A	147kW 265A	160kW 330A	200kW 400A	265kW 500A	330kW 630A	440kW 800A
37 kW 64A	45 kW 75A	55kW 85A	60kW 90A	70kW 100A	110kW 180A	132kW 200A	147kW 225A	160kW 280A	225kW 350A	265kW 400A	330kW 500A	500kW 720A
-	-	2NO2NC		2NO2NC		2NO2NC		2NO2NC		2NO2NC		
1.6	2.4	5.4	9.2	22.4								
70 × 140 × 135.8		95 × 158 × 130.3		138 × 203 × 185.1		163 × 243 × 204.4		285 × 312 × 245.3				
GMC-75	GMC-85	GMC-100	GMC-125	GMC-150	GMC-180	GMC-220	-	GMC-300	GMC-400	-	GMC-600	GMC-800
22kW 75A	25kW 85A	30kW 105A	37kW 125A	45kW 150A	55kW 180A	75kW 250A	-	90kW 300A	125kW 400A	-	190kW 630A	220kW 800A
37kW 75A	45kW 85A	55kW 105A	60kW 120A	75kW 150A	90kW 180A	132kW 250A	-	160kW 300A	200kW 400A	-	330kW 630A	440kW 800A
37kW 64A	45kW 75A	55kW 85A	60kW 90A	90kW 140A	110kW 180A	132kW 200A	-	160kW 250A	225kW 350A	-	330kW 500A	500kW 720A
2NO2NC	2NO2NC	2NO2b	2NO2NC	2NO2NC	2NO2NC	2NO2NC	-	2NO2NC	2NO2NC	-	2NO2NC	2NO2NC
1	2.9	3.4	5.4	9.2	22							
94 × 122 × 115.7		100 × 157.4 × 146.5		120 × 166 × 157		138 × 203 × 181		163 × 243 × 198		285 × 290 × 242		
▲	×	×	○	○	○	○	-	○	○	-	○	○

Meta-MEC and Metasol MS comparison table

		Type	MS-6a	MS-9a	MS-12a	MS-18a	MS-9b	MS-12b	MS-18b	MS-22b	MS-32a	MS-40a	MS-50a	MS-65a	
Manufactured products	Metasol MC	Current and power AC3	200~240V	2.2kW 9A	2.5kW 11A	3.5kW 13A	4.5kW 18A	2.5kW 11A	3.5kW 13A	4.5kW 18A	5.5kW 22A	7.5kW 32A	11kW 40A	15kW 55A	18.5kW 65A
			380~440V	3kW 7A	4kW 9A	5.5kW 12A	7.5kW 18A	4kW 9A	5.5kW 12A	7.5kW 18A	11kW 22A	15kW 32A	18.5kW 40A	22kW 50A	30kW 65A
			500~550V	3kW 6A	4kW 7A	7.5kW 12A	7.5kW 13A	4kW 7A	7.5kW 12A	7.5kW 13A	15kW 20A	18.5kW 28A	22kW 32A	30kW 43A	33kW 60A
		Auxiliary (Standard)		1NO or 1NC				1NO1NC				-		-	
		Mounting size													
		Weight (kg)		0.5				0.5				0.7		1.5	
		Demension (W×H×D)		45 × 124 × 80.4				45 × 129.9 × 87.4				45 × 139.4 × 90		55 × 163.8 × 119	
Discontinued products	Meta-MEC MC	Current and power AC3	200~220V	-			GMS-9	GMS-12	GMS-18	GMS-22	GMS-32	GMS-40	GMS-50	GMS-65	
			380~440V	-			2.5kW 11A	3.5kW 13A	4.5kW 18A	5.5kW 22A	7.5kW 32A	11kW 40A	15kW 55A	18.5kW 65A	
			500~550V	-			4kW 7A	5.5kW 12A	7.5kW 18A	11kW 22A	15kW 32A	18.5kW 40A	22kW 50A	30kW 65A	
		Auxiliary (Standard)		-			1NO1NC	1NO1NC	1NO1NC	1NO1NC	2NO2NC	2NO2NC	2NO2NC	2NO2NC	
		Mounting size		-											
		Weight (kg)		-			0.46		0.5		0.45		1.12		
		Demension (W×H×D)		-			44 × 128.9 × 86.8				68 × 136.5 × 94.6		94 × 181.5 × 115.7		
	Compatibility with Metasol		-			○				×		×			

Note) Marks of compatibility
 ○: can be compatible
 ×: can't be compatible(have to use bracket)

MS-75a	MS-85a	MS-100a	MS-130a	MS-150a	MS-185a	MS-225a	MS-265a	MS-330a	MS-400a	MS-500a	MS-630a	MS-800a
22 kW 75A	25kW 85A	30kW 105A	37kW 130A	45kW 150A	55kW 185A	75kW 225A	80kW 265A	90kW 330A	125kW 400A	147kW 500A	190kW 630A	220kW 800A
37 kW 75A	45kW 85A	55kW 105A	60kW 130A	75kW 150A	90kW 185A	132kW 225A	147kW 265A	160kW 330A	200kW 400A	265kW 500A	330kW 630A	440kW 800A
37 kW 64A	45 kW 75A	55kW 85A	60kW 90A	70kW 100A	110kW 180A	132kW 200A	147kW 225A	160kW 280A	225kW 350A	265kW 400A	330kW 500A	500kW 720A
-	-	2NO2NC		2NO2NC		2NO2NC		2NO2NC		2NO2NC		
2.4	3	7.9		11.8		28						
70 × 211.4 × 135.8		95 × 236.2 × 130.3		138 × 306.5 × 185.1		163 × 380 × 204.4		360 × 530 × 245.3				
GMC-75	GMC-85	GMC-100	GMC-125	GMC-150	GMC-180	GMC-220	-	GMC-300	GMC-400	-	GMC-600	GMC-800
22kW 75A	25kW 85A	30kW 105A	37kW 125A	45kW 150A	55kW 180A	75kW 250A	-	90kW 300A	125kW 400A	-	190kW 630A	220kW 800A
37kW 75A	45kW 85A	55kW 105A	60kW 120A	75kW 150A	90kW 180A	132kW 250A	-	160kW 300A	200kW 400A	-	330kW 630A	440kW 800A
37kW 64A	45kW 75A	55kW 85A	60kW 90A	90kW 140A	110kW 180A	132kW 200A	-	160kW 250A	225kW 350A	-	330kW 500A	500kW 720A
2NO2NC	2NO2NC	2NO2NC	2NO2NC	2NO2NC	2NO2NC	2NO2NC	-	2NO2NC	2NO2NC	-	2NO2NC	2NO2NC
1.12	3.4	4	7.9	-	11.8	-	28					
94 × 181.5 × 115.7		114 × 231.4 × 146.5		120 × 206.4 × 157		138 × 306.54 × 181		163 × 380 × 198		360 × 530 × 262		
×		×		○		-		○		-		

Meta-MEC and Metasol relays comparison table

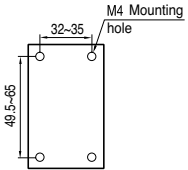
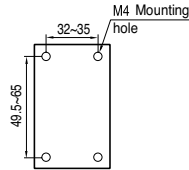
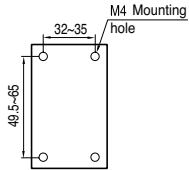
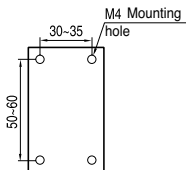
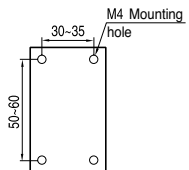
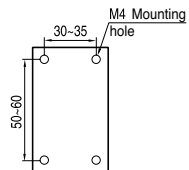
		Type	MR-4	MR-6	MR-8
Manufactured products	Metasol MR	Auxiliary (kW)	4NO, 3NO1NC, 2NO2NC 1NO3NC, 4NC	6NO, 5NO1NC, 4NO2NC 3NO3NC, 2NO4NC	8NO, 7NO1NC, 6NO2NC 5NO3NC, 4NO4NC
		Rated current (A)	120 V	6	6
	AC15	240 V	3	3	3
		Mounting size			
		Dimension (W×H×D)	45×73.5×79(96.6)	45×73.5×109.6(127.2)	45×73.5×109.6(127.2)
		Weight (kg)	0.284	0.315	0.339
Discontinued products	GMR	Auxiliary (kW)	4NO, 3NO1NC, 2NO2NC 1NO3NC, 4NC	6NO, 5NO1NC, 4NO2NC 3NO3NC, 2NO4NC	8NO, 7NO1NC, 6NO2NC 5NO3NC, 4NO4NC
		Rated current (A)	AC110V	6	6
	AC11	AC220V	5	5	5
		Mounting size			
		Dimension (W×H×D)	44×80×86.8(113.2)	44×80×118.6(145)	44×80×118.6(145)
		Weight (kg)	0.34(0.56)	0.37(0.59)	0.39(0.61)

Meta-MEC and Metasol TOR comparison table







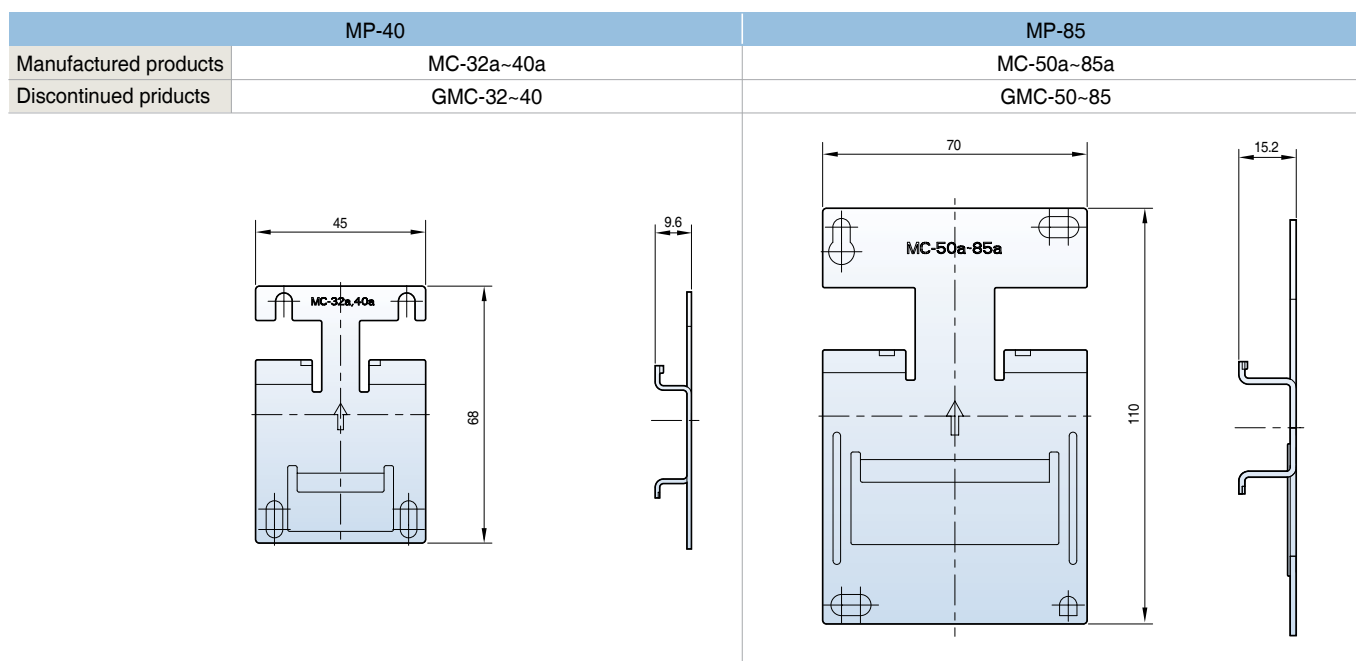

Manufactured products		Discontinued products	
MT		GTH (K)	
MT-12	0.14(0.1~0.16), 0.21(0.16~0.25), 0.33(0.25~0.4), 0.52(0.4~0.63), 0.82(0.63~1), 1.3(1~1.6), 2.1(1.6~2.5), 3.3(2.5~4), 5(4~6), 6.5(5~8), 7.5(6~9), 8.5(7~10), 11(9~13), 15(12~18), 19(16~22)	GTH(K)-22	0.14(0.1~0.16), 0.21(0.16~0.25), 0.33(0.25~0.4), 0.52(0.4~0.63), 0.82(0.63~1), 1.3(1~1.6), 2.1(1.6~2.5), 3.3(2.5~4), 5(4~6), 6.5(5~8), 7.5(6~9), 8.5(7~10), 11(9~13), 15(12~18), 19(16~22)
MT-32	0.14(0.1~0.16), 0.21(0.16~0.25), 0.33(0.25~0.4), 0.52(0.4~0.63), 0.82(0.63~1), 5(4~6), 6.5(5~8), 7.5(6~9), 8.5(7~10), 11(9~13), 15(12~18), 19(16~22), 22(18~26), 34(28~40)	GTH(K)-40	5(4~6), 6.5(5~8), 7.5(6~9), 8.5(7~10), 11(9~13), 15(12~18), 19(16~22), 22(18~26), 30(24~36), 34(28~40)
MT-63	5(4~6), 6.5(5~8), 7.5(6~9), 8.5(7~10), 11(9~13), 15(12~18), 19(16~22), 22(18~26), 30(24~36), 34(28~40), 42(34~50), 54(45~65)	GTH(K)-85	8.5(7~10), 11(9~13), 15(12~18), 19(16~22), 22(18~26), 30(24~36), 34(28~40), 42(34~50), 55(45~65), 65(54~75), 74(63~85)
MT-95	8.5(7~10), 11(9~13), 15(12~18), 19(16~22), 22(18~26), 30(24~36), 34(28~40), 42(34~50), 54(45~65), 65(54~75), 74(63~85), 83(70~95), 90(80~100)	GTH(K)-100	41(34~50), 48(39~57), 56(43~65), 67(54~80), 80(65~100), 107(85~125)
MT-150	42(34~50), 55(45~65), 65(54~75), 74(63~85), 93(80~105), 113(95~130), 130(110~150)	GTH(K)-150	41(34~50), 48(39~57), 56(43~65), 67(54~80), 80(65~100), 107(85~125), 130(100~150)
MT-225	80(65~100), 107(85~125), 130(100~160), 153(120~185), 200(160~240)	GTH(K)-220	80(65~100), 107(85~125), 130(100~160), 150(120~180), 200(160~240)
MT-400	107(85~125), 130(100~160), 153(120~185), 200(160~240), 265(200~330), 350(260~400)	GTH(K)-400	107(85~125), 130(100~160), 150(120~180), 200(160~240), 250(200~300), 350(260~400)
MT-800	265(200~300), 350(260~400), 515(400~630), 660(520~800)	GTH(K)-600	250(200~300), 350(260~400), 500(400~600), 660(520~800)

Compatibility bracket

- Mounting Metasol MC on Din-Rail of bracket after install the bracket on panel
- Please use compatibility bracket when replace from Meta-MEC to Metasol MC without to change of panel size











Certifications

Type	Type	Approvals					Certificates		
	Certificate	-	IEC	UL	CSA	GB	IEC		KEPIC
	Mark and name								
		Korea	Europe	U.S.A & Canada	Canada	China	Netherlands	Denmark	Korea
Metasol Contactors	MC-6a	•	•	•	•	•	•		•
	MC-9a	•	•	•	•	•	•		•
	MC-12a	•	•	•	•	•	•		•
	MC-18a	•	•	•	•	•	•		•
	MC-9b	•	•	•	•	•	•	•	•
	MC-12b	•	•	•	•	•	•	•	•
	MC-18b	•	•	•	•	•	•	•	•
	MC-22b	•	•	•	•	•	•	•	•
	MC-32a	•	•	•	•	•	•		•
	MC-40a	•	•	•	•	•	•		•
	MC-50a	•	•	•	•	•	•		•
	MC-65a	•	•	•	•	•	•		•
	MC-75a	•	•	•	•	•	•		•
	MC-85a	•	•	•	•	•	•		•
	MC-100a	•	•	•	•	•	•		•
	MC-130a	•	•	•	•	•	•		•
	MC-150a	•	•	•	•	•	•		•
	MC-185a	•	•	•	•	•	•		•
	MC-225a	•	•	•	•	•	•		•
	MC-265a	•	•	•	•	•	•		•
MC-330a		•	•	•	•	•		•	
MC-400a		•	•	•	•	•		•	
MC-500a		•	•	•	•	•		•	
MC-630a		•	•	•	•	•		•	
MC-800a		•	•	•	•	•		•	
Thermal Overload Relays Nondifferential (2-heater)	MT-12/2H		•	•			•		•
	MT-32/2H		•	•	•	•	•		•
	MT-63/2H		•	•	•	•	•		•
	MT-95/2H		•	•	•	•	•		•
	MT-150/2H		•	•	•		•		•
	MT-225/2H		•	•	•		•		•
	MT-400/2H		•	•	•		•		•
MT-800/2H		•	•	•		•		•	
Thermal Overload Relays Nondifferential (3-heater)	MT-12/3H		•	•			•		•
	MT-32/3H		•	•	•	•	•		•
	MT-63/3H		•	•	•	•	•		•
	MT-95/3H		•	•	•	•	•		•
	MT-150/3H		•	•	•		•		•
	MT-225/3H		•	•	•		•		•
	MT-400/3H		•	•	•		•		•
MT-800/3H		•	•	•		•		•	
Thermal Overload Relays Differential	MT-12/3K		•	•			•		•
	MT-32/3K		•	•	•	•	•		•
	MT-63/3K		•	•	•	•	•		•
	MT-95/3K		•	•	•	•	•		•
	MT-150/3K		•	•	•		•		•
	MT-225/3K		•	•	•		•		•
	MT-400/3K		•	•	•		•		•
MT-800/3K		•	•	•		•		•	
Thermal Overload Relays Class 20	MT-12/3D		•	•			•		•
	MT-32/3D		•	•	•	•	•		•
	MT-63/3D		•	•	•	•	•		•
	MT-95/3D		•	•	•	•	•		•
	MT-150/3D		•	•	•		•		•
	MT-225/3D		•	•	•		•		•
MT-400/3D		•	•	•		•		•	
MT-800/3D		•	•	•		•		•	

Note) • : Completion

Marine certifications

Type		Approvals							
		 KR Korea	 LR U.K	 BV France	 GL Germany	 DNV Norway	 ABS U.S.A	 NK Japan	 RINA Italy
Metasol Contactors	MC-6a	●	●	●	●	●	●	●	●
	MC-9a	●	●	●	●	●	●	●	●
	MC-12a	●	●	●	●	●	●	●	●
	MC-18a	●	●	●	●	●	●	●	●
	MC-9b	●	●	●	●	●	●	●	●
	MC-12b	●	●	●	●	●	●	●	●
	MC-18b	●	●	●	●	●	●	●	●
	MC-22b	●	●	●	●	●	●	●	●
	MC-32a	●	●	●	●	●	●	●	●
	MC-40a	●	●	●	●	●	●	●	●
	MC-50a	●	●	●	●	●	●	●	●
	MC-65a	●	●	●	●	●	●	●	●
	MC-75a	●	●	●	●	●	●	●	●
	MC-85a	●	●	●	●	●	●	●	●
	MC-100a	●	●	●	●	●	●	●	●
	MC-130a	●	●	●	●	●	●	●	●
	MC-150a	●	●	●	●	●	●	●	●
	MC-185a	●	●	●	●	●	●	●	●
	MC-225a	●	●	●	●	●	●	●	●
	MC-265a	●	●	●	●	●	●	●	●
MC-330a	●	●	●	●	●	●	●	●	
MC-400a	●	●	●	●	●	●	●	●	
MC-500a	●	●	●	●	●	●	●	●	
MC-630a	●	●	●	●	●	●	●	●	
MC-800a	●	●	●	●	●	●	●	●	
Thermal Overload Relays Nondifferential (2-heater)	MT-12/2H	●	●	●	●	●	●	●	●
	MT-32/2H	●	●	●	●	●	●	●	●
	MT-63/2H	●	●	●	●	●	●	●	●
	MT-95/2H	●	●	●	●	●	●	●	●
	MT-150/2H	●	●	●	●	●	●	●	●
	MT-225/2H	●	●	●	●	●	●	●	●
	MT-400/2H	●	●	●	●	●	●	●	●
MT-800/2H	●	●	●	●	●	●	●	●	
Thermal Overload Relays Nondifferential (3-heater)	MT-12/3H	●	●	●	●	●	●	●	●
	MT-32/3H	●	●	●	●	●	●	●	●
	MT-63/3H	●	●	●	●	●	●	●	●
	MT-95/3H	●	●	●	●	●	●	●	●
	MT-150/3H	●	●	●	●	●	●	●	●
	MT-225/3H	●	●	●	●	●	●	●	●
	MT-400/3H	●	●	●	●	●	●	●	●
MT-800/3H	●	●	●	●	●	●	●	●	
Thermal Overload Relays Differential	MT-12/3K	●	●	●	●	●	●	●	●
	MT-32/3K	●	●	●	●	●	●	●	●
	MT-63/3K	●	●	●	●	●	●	●	●
	MT-95/3K	●	●	●	●	●	●	●	●
	MT-150/3K	●	●	●	●	●	●	●	●
	MT-225/3K	●	●	●	●	●	●	●	●
	MT-400/3K	●	●	●	●	●	●	●	●
MT-800/3K	●	●	●	●	●	●	●	●	
Thermal Overload Relays Class 20	MT-12/3D	●	●	●	●	●	●	●	●
	MT-32/3D	●	●	●	●	●	●	●	●
	MT-63/3D	●	●	●	●	●	●	●	●
	MT-95/3D	●	●	●	●	●	●	●	●
	MT-150/3D	●	●	●	●	●	●	●	●
	MT-225/3D	●	●	●	●	●	●	●	●
MT-400/3D	●	●	●	●	●	●	●	●	
MT-800/3D	●	●	●	●	●	●	●	●	

Note) ● : Completion





Safety Instructions

- For your safety, please read user's manual thoroughly before operating.
- Contact the nearest authorized service facility for examination, repair, or adjustment.
- Please contact qualified service technician when you need maintenance. Do not disassemble or repair by yourself!
- Any maintenance and inspection shall be performed by the personnel having expertise concerned.



© 2008.10 LSIS Co.,Ltd. All rights reserved.

www.lsis.com/usa

■ LSIS usa Inc. Chicago Branch

2000 Millbrook Drive Lincolnshire, IL 60069
 Tel : 847-941-8240~59 sales.us@lsis.com
 Fax. 82-2-2034-4555

■ HEAD OFFICE

LS-ro 127 (Hogye-dong) Dongan-gu, Anyang-si,
 Gyeonggi-Do Korea
 Tel. 82-2-2034-4902, 4684, 4429 Fax. 82-2-2034-4555

Technical Question or After-sales Service



TEL. 82-1644-5481

Customer Center-Quick Responsive
 Service, Excellent technical support

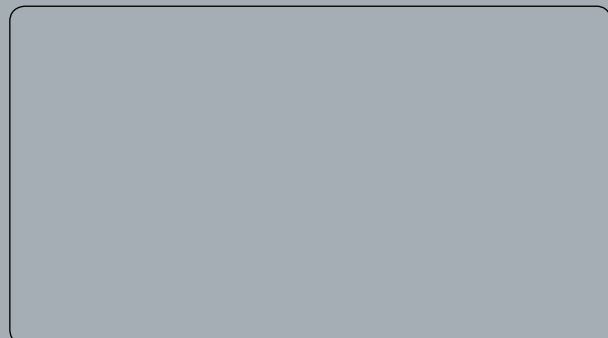

Specifications in this catalog are subject to change without notice due to continuous product development and improvement.

■ GLOBAL NETWORK

Overseas Subsidiaries

- **LSIS USA Inc.** » **Chicago, America**
 2000 Millbrook Drive, Lincolnshire, Chicago, IL 60069, United States of America
 Tel: 1-847-941-8240 Fax: 1-847-941-8259 E-mail: seunghonc@lsis.com
- **LSIS (Middle East) FZE** » **Dubai, U.A.E.**
 LOB 19-205, JAFZA View Tower, Jebel Ali Free Zone, Dubai, United Arab Emirates
 Tel: 971-4-886-5360 Fax: 971-4-886-5361 E-mail: hschoib@lsis.com
- **LSIS Europe B.V.** » **Schiphol-Rijk, Netherlands**
 1st Floor, Tupoleviaan 48, 1119NZ, Schiphol-Rijk, The Netherlands
 Tel: 31-20-654-1420 Fax: 31-20-654-1429 E-mail: junshickp@lsis.com
- **LSIS Japan Co., Ltd.** » **Tokyo, Japan**
 Tokyo Club Building 13F, 2-6, Kasumigaseki 3-chome, Chiyoda-ku, Tokyo, 100-0013
 Tel: 81-3-6268-8241 Fax: 81-3-6268-8240 E-mail: jschuna@lsis.com
- **LSIS(Dalian) Co., Ltd.** » **Dalian, China**
 No. 15, Liaohexi 3-Road, Economic and Technical Development Zone, Dalian 116600, China
 Tel: 86-411-8273-7777 Fax: 86-411-8730-7560 E-mail: tangyh@lsis.com
- **LS IS(Wuxi) Co., Ltd.** » **WUxi, China**
 102-A, National High & New Tech Industrial Development Area, Wuxi, Jiangsu, 214028, P.R.China
 Tel: 86-510-8534-6666 Fax: 86-510-522-4078 E-mail: wangzy@lsis.com
- **LS-Vina Co., Ltd.** » **Hanoi, Vietnam**
 Nguyen Khe, Dong Anh, Hanoi, Vietnam
 Tel: 84-4-6275-8055 Fax: 84-4-3882-0220 E-mail: sjbaik@lsis.com

Overseas Branches

- **LSIS Co., Ltd, Indonesia**
 APL TOWER lantai 10 unit 3, Jl. Letjen S. Parman Kav. 28, 11470, Jakarta Barat, Indonesia
 Tel: 62-21-2933-7614 Fax: 62-21-2933-7624 E-mail: dioh@lsis.com
- **LSIS Moscow Office, Russia**
 123610, Krasnopresnenskaya, nab, 12, building1, office No.1005, Moscow, Russia
 Tel: 7-495-258-1466, 1467 Fax: 7-495-258-1466, 1467 E-mail: jdpark1@lsis.com